

# Data Sheet

## Features

- For 3G applications
- 15 MHz bandwidth for high data rates
- High attenuation
- Single-ended operation at 50Ω
- Ceramic Surface Mount Package (SMP)
- Small size

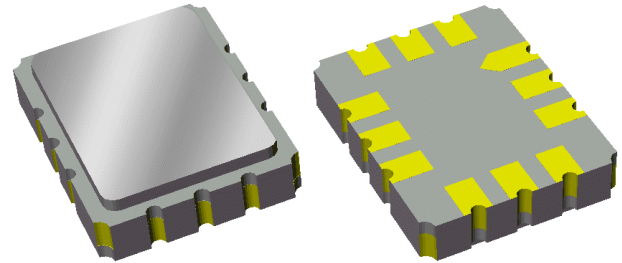

## Package

Surface Mount 7.01 x 5.51 x 1.63 mm

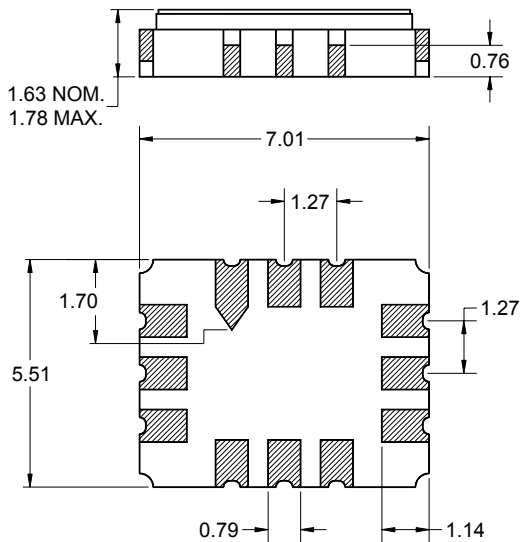

## Pin Configuration

Bottom View

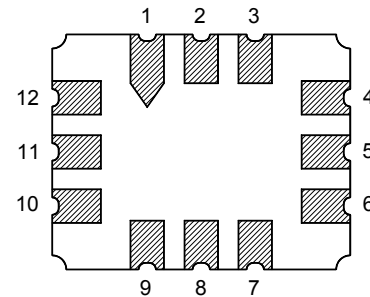

Pin No.	Description
4	Output
10	Input
1,2,3,5,6	Case ground
7,8,9,11,12	Case ground

Dimensions shown are nominal in millimeters  
 All tolerances are  $\pm 0.15\text{mm}$  except overall  
 length and width  $\pm 0.13\text{mm}$

Body:  $\text{Al}_2\text{O}_3$  ceramic  
 Lid: Kovar, Ni plated  
 Terminations: Au plating 0.5 - 1.0  $\mu\text{m}$ ,  
 over a 2 - 6  $\mu\text{m}$  Ni plating

# Data Sheet

## Electrical Specifications <sup>(1)</sup>

Temperature Range: <sup>(2)</sup> -10 to +80 °C

Parameter <sup>(3)</sup>	Minimum	Typical	Maximum	Unit
<b>Center Frequency</b>	-	326.4	-	MHz
<b>Minimum Insertion Loss</b>	-	12.61	17	dB
<b>2 dB Lower Frequency</b>	-	317.77	318.9	MHz
<b>2 dB Upper Frequency</b>	333.9	335.18	-	MHz
<b>2 dB Bandwidth</b>	15	17.4	-	MHz
<b>40 dB Lower Frequency</b>	313.9	314.62	-	MHz
<b>40 dB Upper Frequency</b>	-	338.31	338.9	MHz
<b>40 dB Bandwidth</b>	-	23.69	25	MHz
<b>Relative Attenuation</b>				
10 - 276.4 MHz	50	60	-	dB
276.4 - 306.4 MHz	45	51	-	dB
346.4 - 376.4 MHz	45	56	-	dB
376.4 - 450 MHz	50	64	-	dB
<b>Amplitude Ripple</b>				
323.9 - 328.9 MHz	-	0.2	0.5	dB p-p
<b>Group Delay Variation</b>				
318.9 - 333.9 MHz	-	24	50	nsec
<b>Input VSWR</b>				
318.9 - 333.9 MHz	-	1.33:1	2.0:1	-
<b>Output VSWR</b>				
318.9 - 333.9 MHz	-	1.34:1	2.0:1	-
<b>Source Impedance <sup>(4)</sup></b>	-	50	-	Ω
<b>Load Impedance <sup>(4)</sup></b>	-	50	-	Ω

**Notes:**

1. All specifications are based on the test circuit shown below
2. In production, devices will be tested at room temperature to a guardbanded specification to ensure electrical compliance over temperature
3. Electrical margin has been built into the design to account for the variations due to temperature drift and manufacturing tolerances
4. This is the optimum impedance in order to achieve the performance shown

**Test Circuit:**

Actual matching values may vary due to PCB layout and parasitics

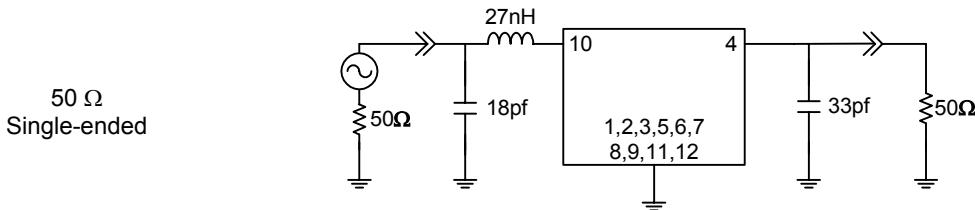

**Data Sheet**

**Typical Performance (at +25°C)**

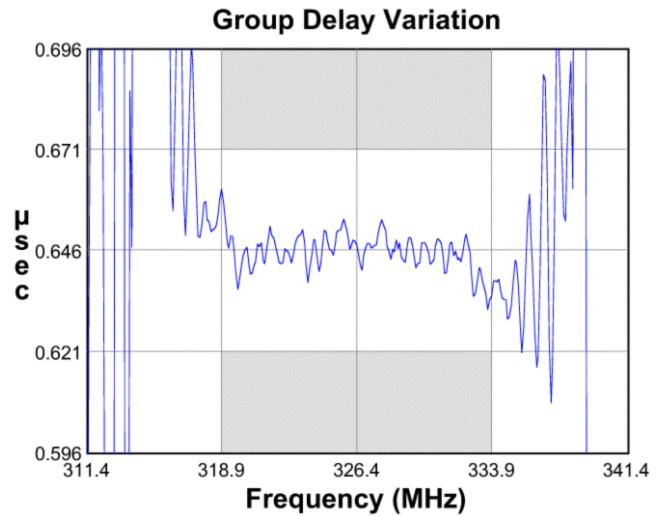
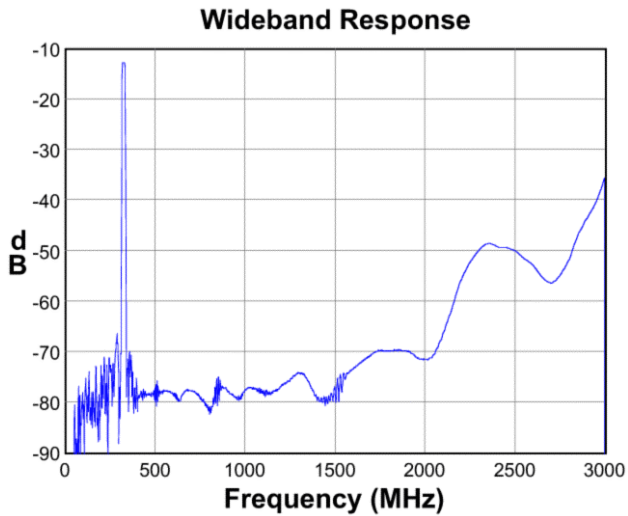
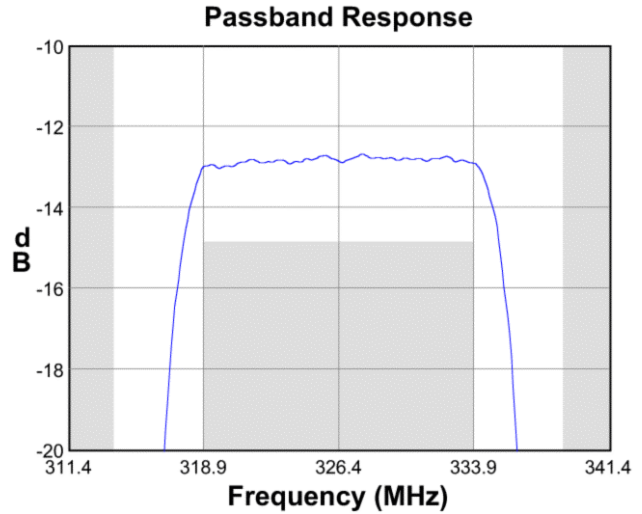
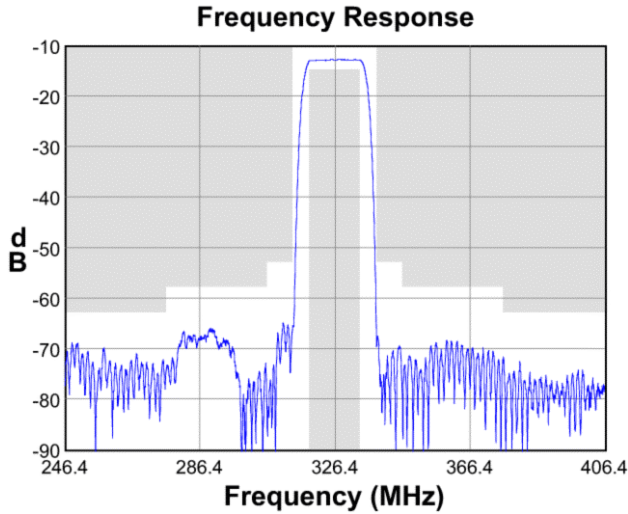

**Input Smith Chart**

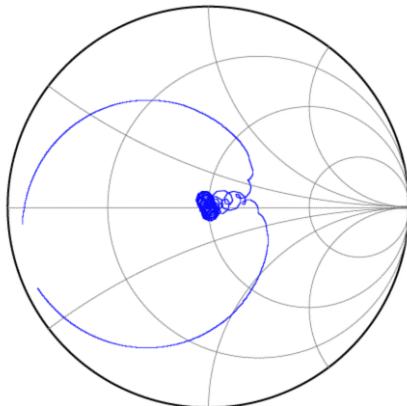

**Output Smith Chart**

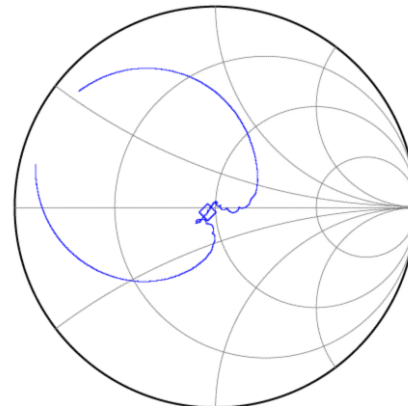

**Data Sheet**

**Matching Schematics**

Actual matching values may vary due to PCB layout and parasitics

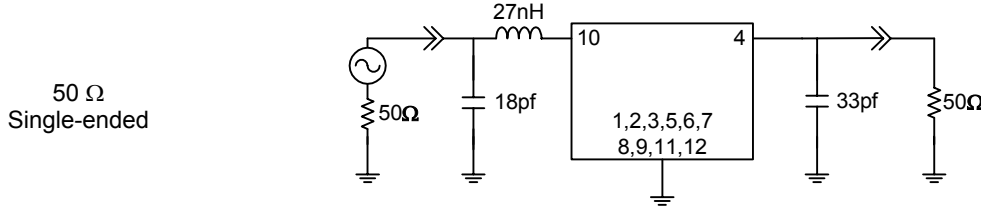

**Marking**

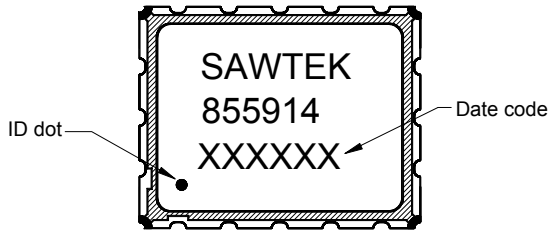

The date code consists of: day of the current year (Julian, 3 digits), last digit of the year (1 digit) and hour (2 digits)

**PCB Footprint**

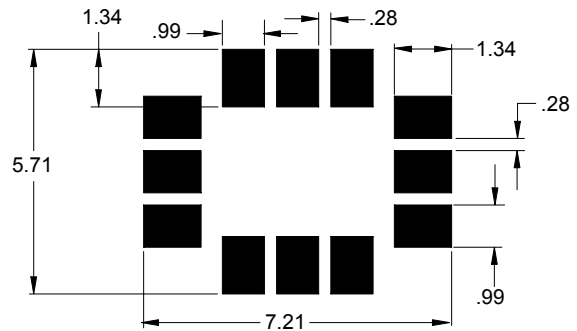

This footprint represents a recommendation only  
Dimensions shown are nominal in millimeters

**Tape and Reel**

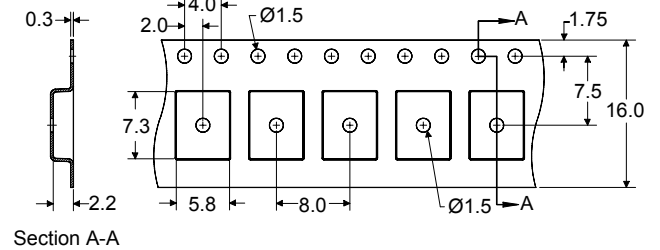
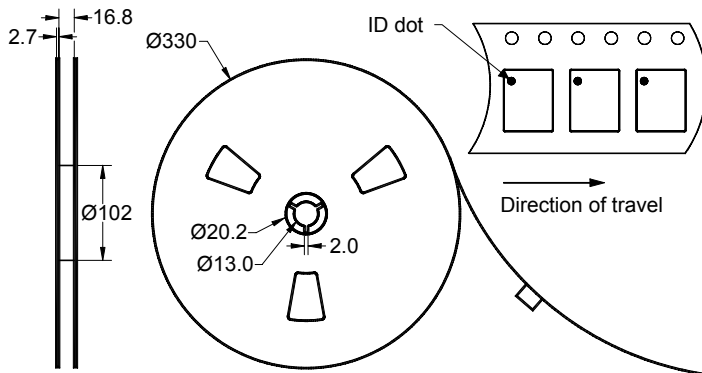

Dimensions shown are nominal in millimeters  
Packaging quantity: 3000 units/reel

# Data Sheet

## Maximum Ratings

Parameter	Symbol	Minimum	Maximum	Unit
Operating Temperature Range	T	-10	+80	°C
Storage Temperature Range	T <sub>stg</sub>	-40	+85	°C
Input Power	P <sub>in</sub>	-	+15	dBm

### Warnings

- Electrostatic Sensitive Device (ESD) 
- Avoid ultrasonic exposure

## Links to Additional Technical Information

[PCB Layout Tips](#)

[Qualification Flowchart](#)

[Soldering Profile](#)

[S-Parameters](#)

[Other Technical Information](#)

Sawtek's liability is limited only to the Surface Acoustic Wave (SAW) component(s) described in this data sheet. Sawtek does not accept any liability for applications, processes, circuits or assemblies which are implemented using any Sawtek component described in this data sheet.

## Contact Information



PO Box 609501  
 Orlando, FL 32860-9501  
 USA

Phone: +1 (407) 886-8860  
 Fax: +1 (407) 886-7061  
 Email: [custservice@sawtek.com](mailto:custservice@sawtek.com)  
 Web: [www.sawtek.com](http://www.sawtek.com)

Or contact one of our worldwide network of [sales offices](#), [representatives](#) or [distributors](#)