

Advanced Information

Notice: This is not final specification.
Some parametric limits are subject to change.

MITSUBISHI LSIs
M5M5V5636GP -16

18874368-BIT(524288-WORD BY 36-BIT) NETWORK SRAM

DESCRIPTION

The M5M5V5636GP is a family of 18M bit synchronous SRAMs organized as 524288-words by 36-bit. It is designed to eliminate dead bus cycles when turning the bus around between reads and writes, or writes and reads. Mitsubishi's SRAMs are fabricated with high performance, low power CMOS technology, providing greater reliability. M5M5V5636GP operates on 3.3V power/ 2.5V I/O supply or a single 3.3V power supply and are 3.3V CMOS compatible.

FEATURES

- Fully registered inputs and outputs for pipelined operation
- Fast clock speed: 167 MHz
- Fast access time: 3.8 ns
- Single 3.3V -5% and +5% power supply V_{DD}
- Separate V_{DDQ} for 3.3V or 2.5V I/O
- Individual byte write (BWa# - BWd#) controls may be tied LOW
- Single Read/Write control pin (W#)
- CKE# pin to enable clock and suspend operations
- Internally self-timed, registers outputs eliminate the need to control G#
- Snooze mode (ZZ) for power down
- Linear or Interleaved Burst Modes
- Three chip enables for simple depth expansion

Package

100pin TQFP

APPLICATION

High-end networking products that require high bandwidth, such as switches and routers.

FUNCTION

Synchronous circuitry allows for precise cycle control triggered by a positive edge clock transition.

Synchronous signals include : all Addresses, all Data Inputs, all Chip Enables (E1#, E2, E3#), Address Advance/Load (ADV), Clock Enable (CKE#), Byte Write Enables (BWa#, BWb#, BWc#, BWd#) and Read/Write (W#). Write operations are controlled by the four Byte Write Enables (BWa# - BWd#) and Read/Write(W#) inputs. All writes are conducted with on-chip synchronous self-timed write circuitry.

Asynchronous inputs include Output Enable (G#), Clock (CLK) and Snooze Enable (ZZ). The HIGH input of ZZ pin puts the SRAM in the power-down state. The Linear Burst order (LBO#) is DC operated pin. LBO# pin will allow the choice of either an interleaved burst, or a linear burst.

All read, write and deselect cycles are initiated by the ADV LOW input. Subsequent burst address can be internally generated as controlled by the ADV HIGH input.

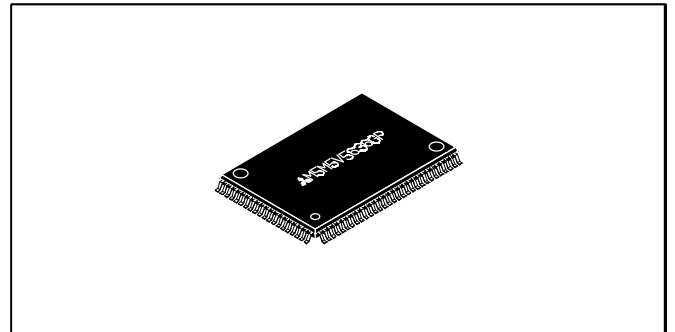
**PART NAME TABLE**

Part Name	Frequency	Access	Cycle	Active Current (max.)	Standby Current (max.)
M5M5V5636GP - 16	167MHz	3.8ns	6.0ns	340mA	20mA



MITSUBISHI LSIs
M5M5V5636GP –16

18874368-BIT(524288-WORD BY 36-BIT) NETWORK SRAM

PIN CONFIGURATION(TOP VIEW)

100pin TQFP

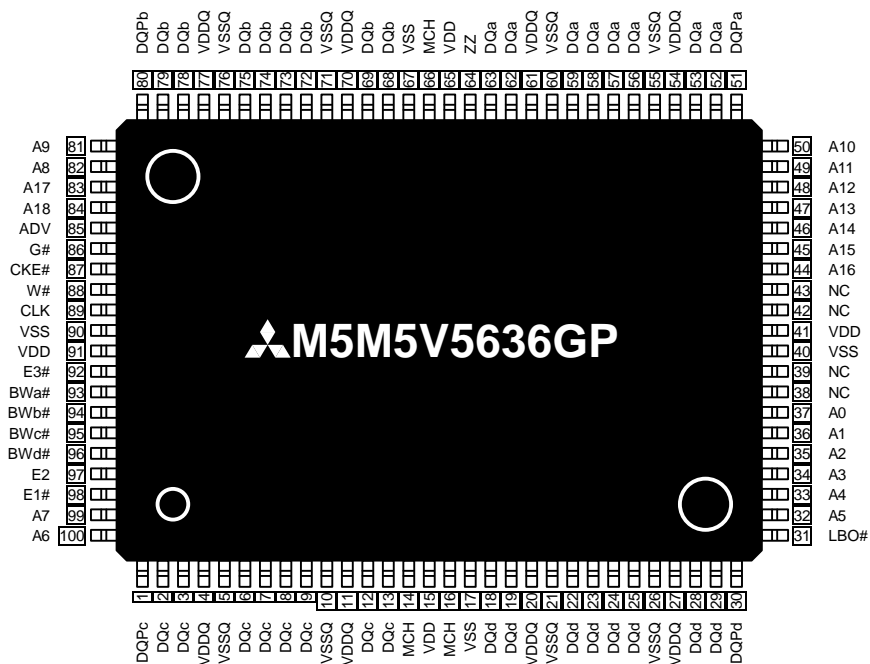

Note1. MCH means "Must Connect High". MCH should be connected to HIGH.

MITSUBISHI LSIs
M5M5V5636GP –16

18874368-BIT(524288-WORD BY 36-BIT) NETWORK SRAM

BLOCK DIAGRAM

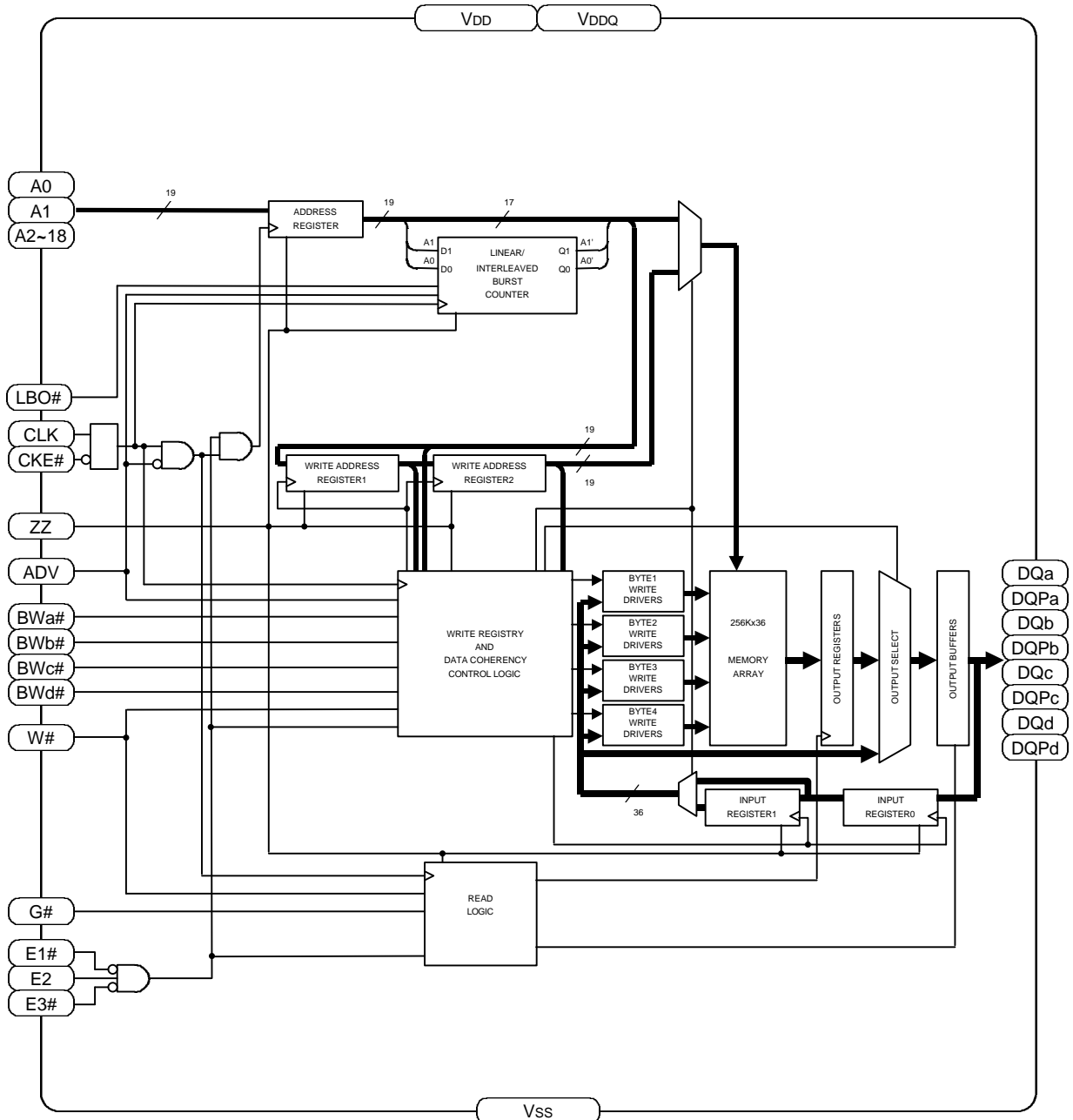

Note2. The BLOCK DIAGRAM does not include the Boundary Scan logic. See Boundary Scan chapter.

Note3. The BLOCK DIAGRAM illustrates simplified device operation. See TRUTH TABLE, PIN FUNCTION and timing diagrams for detailed information.

MITSUBISHI LSIs
M5M5V5636GP –16

18874368-BIT(524288-WORD BY 36-BIT) NETWORK SRAM

PIN FUNCTION

Pin	Name	Function
A0~A18	Synchronous Address Inputs	These inputs are registered and must meet the setup and hold times around the rising edge of CLK. A0 and A1 are the two least significant bits (LSB) of the address field and set the internal burst counter if burst is desired.
BWa#, BWb#, BWc#, BWd#	Synchronous Byte Write Enables	These active LOW inputs allow individual bytes to be written when a WRITE cycle is active and must meet the setup and hold times around the rising edge of CLK. BYTE WRITES need to be asserted on the same cycle as the address. BWs are associated with addresses and apply to subsequent data. BWa# controls DQa, DQPa pins; BWb# controls DQb, DQPb pins; BWc# controls DQc, DQc pins; BWd# controls DQd, DQPd pins.
CLK	Clock Input	This signal registers the address, data, chip enables, byte write enables and burst control inputs on its rising edge. All synchronous inputs must meet setup and hold times around the clock's rising edge.
E1#	Synchronous Chip Enable	This active LOW input is used to enable the device and is sampled only when a new external address is loaded (ADV is LOW).
E2	Synchronous Chip Enable	This active High input is used to enable the device and is sampled only when a new external address is loaded (ADV is LOW). This input can be used for memory depth expansion.
E3#	Synchronous Chip Enable	This active Low input is used to enable the device and is sampled only when a new external address is loaded (ADV is LOW). This input can be used for memory depth expansion.
G#	Output Enable	This active LOW asynchronous input enable the data I/O output drivers.
ADV	Synchronous Address Advance/Load	When HIGH, this input is used to advance the internal burst counter, controlling burst access after the external address is loaded. When HIGH, W# is ignored. A LOW on this pin permits a new address to be loaded at CLK rising edge.
CKE#	Synchronous Clock Enable	This active LOW input permits CLK to propagate throughout the device. When HIGH, the device ignores the CLK input and effectively internally extends the previous CLK cycle. This input must meet setup and hold times around the rising edge of CLK.
ZZ	Snooze Enable	This active HIGH asynchronous input causes the device to enter a low-power standby mode in which all data in the memory array is retained. When active, all other inputs are ignored. When this pin is LOW or NC, the SRAM normally operates.
W#	Synchronous Read/Write	This active input determines the cycle type when ADV is LOW. This is the only means for determining READs and WRITEs. READ cycles may not be converted into WRITEs (and vice versa) other than by loading a new address. A LOW on the pin permits BYTE WRITE operations and must meet the setup and hold times around the rising edge of CLK. Full bus width WRITEs occur if all byte write enables are LOW.
DQa,DQPa,DQb,DQPb DQc,DQc,DQd,DQPd	Synchronous Data I/O	Byte "a" is DQa , DQPa pins; Byte "b" is DQb, DQPb pins; Byte "c" is DQc, DQc pins; Byte "d" is DQd,DQPd pins. Input data must meet setup and hold times around CLK rising edge.
LBO#	Burst Mode Control	This DC operated pin allows the choice of either an interleaved burst or a linear burst. If this pin is HIGH or NC, an interleaved burst occurs. When this pin is LOW, a linear burst occurs, and input leak current to this pin.
VDD	VDD	Core Power Supply
VSS	VSS	Core Ground
VDDQ	VDDQ	I/O buffer Power supply
VSSQ	VSSQ	I/O buffer Ground
MCH	Must Connect High	These pins should be connected to HIGH
NC	No Connect	These pins are not internally connected and may be connected to ground.



MITSUBISHI LSIs
M5M5V5636GP –16

18874368-BIT(524288-WORD BY 36-BIT) NETWORK SRAM

DC OPERATED TRUTH TABLE

Name	Input Status	Operation
LBO#	HIGH or NC	Interleaved Burst Sequence
	LOW	Linear Burst Sequence

Note4. LBO# is DC operated pin.

Note5. NC means No Connection.

Note6. See BURST SEQUENCE TABLE about interleaved and Linear Burst Sequence.

BURST SEQUENCE TABLE

Interleaved Burst Sequence (when LBO# = HIGH or NC)

Operation	A18~A2	A1,A0			
First access, latch external address	A18~A2	0, 0	0, 1	1, 0	1, 1
Second access(first burst address)	latched A18~A2	0, 1	0, 0	1, 1	1, 0
Third access(second burst address)	latched A18~A2	1, 0	1, 1	0, 0	0, 1
Fourth access(third burst address)	latched A18~A2	1, 1	1, 0	0, 1	0, 0

Linear Burst Sequence (when LBO# = LOW)

Operation	A18~A2	A1,A0			
First access, latch external address	A18~A2	0, 0	0, 1	1, 0	1, 1
Second access(first burst address)	latched A18~A2	0, 1	1, 0	1, 1	0, 0
Third access(second burst address)	latched A18~A2	1, 0	1, 1	0, 0	0, 1
Fourth access(third burst address)	latched A18~A2	1, 1	0, 0	0, 1	1, 0

Note7. The burst sequence wraps around to its initial state upon completion.

TRUTH TABLE

E1#	E2	E3#	ZZ	ADV	W#	BWx#	G#	CKE#	CLK	DQ	Address used	Operation
H	X	X	L	L	X	X	X	L	L->H	High-Z	None	Deselect Cycle
X	L	X	L	L	X	X	X	L	L->H	High-Z	None	Deselect Cycle
X	X	H	L	L	X	X	X	L	L->H	High-Z	None	Deselect Cycle
X	X	X	L	H	X	X	X	L	L->H	High-Z	None	Continue Deselect Cycle
L	H	L	L	L	H	X	L	L	L->H	Q	External	Read Cycle, Begin Burst
X	X	X	L	H	X	X	L	L	L->H	Q	Next	Read Cycle, Continue Burst
L	H	L	L	L	H	X	H	L	L->H	High-Z	External	NOP/Dummy Read, Begin Burst
X	X	X	L	H	X	X	H	L	L->H	High-Z	Next	Dummy Read, Continue Burst
L	H	L	L	L	L	L	X	L	L->H	D	External	Write Cycle, Begin Burst
X	X	X	L	H	X	L	X	L	L->H	D	Next	Write Cycle, Continue Burst
L	H	L	L	L	L	H	X	L	L->H	High-Z	None	NOP/Write Abort, Begin Burst
X	X	X	L	H	X	H	X	L	L->H	High-Z	Next	Write Abort, Continue Burst
X	X	X	L	X	X	X	X	H	L->H	-	Current	Ignore Clock edge, Stall
X	X	X	H	X	X	X	X	X	X	High-Z	None	Snooze Mode

Note8. X means "don't care". H means logic HIGH. L means logic LOW.

Note9. BWx#=H means all Synchronous Byte Write Enables (BWa#,BWb#,BWc#,BWd#) are HIGH. BWx#=L means one or more Synchronous Byte Write Enables are LOW.

Note10. All inputs except G# and ZZ must meet setup and hold times around the rising edge (LOW to HIGH) of CLK.



STATE DIAGRAM

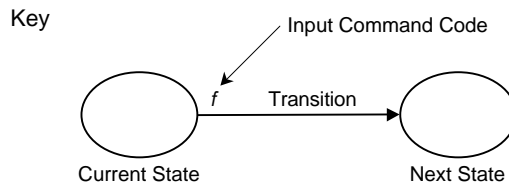
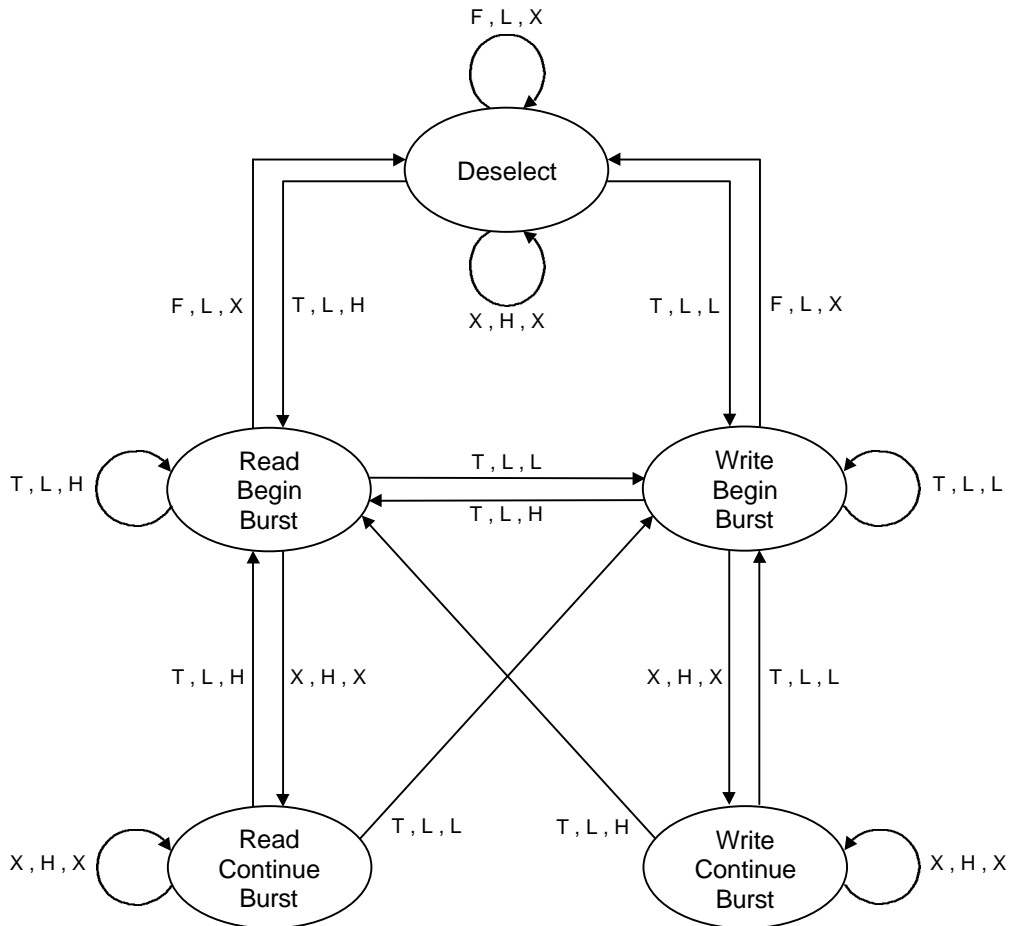

Note11. The notation "x , x , x" controlling the state transitions above indicate the state of inputs E, ADV and W# respectively.

Note12. If (E1# = L and E2 = H and E3# = L) then E="T" else E="F".

Note13. "H" = input "high"; "L" = input "low"; "X" = input "don't care"; "T" = input "true"; "F" = input "false".

MITSUBISHI LSIs
M5M5V5636GP –16

18874368-BIT(524288-WORD BY 36-BIT) NETWORK SRAM

WRITE TRUTH TABLE

W#	BWa#	BWb#	BWc#	BWd#	Function
H	X	X	X	X	Read
L	L	H	H	H	Write Byte a
L	H	L	H	H	Write Byte b
L	H	H	L	H	Write Byte c
L	H	H	H	L	Write Byte d
L	L	L	L	L	Write All Bytes
L	H	H	H	H	Write Abort/NOP

Note14. X means "don't care". H means logic HIGH. L means logic LOW.

Note15. All inputs except G# and ZZ must meet setup and hold times around the rising edge (LOW to HIGH) of CLK.

ABSOLUTE MAXIMUM RATINGS

Symbol	Parameter	Conditions	Ratings	Unit
VDD	Power Supply Voltage	With respect to Vss	-1.0*~4.6	V
VDDQ	I/O Buffer Power Supply Voltage		-1.0*~4.6	V
Vi	Input Voltage		-1.0~VDDQ+1.0**	V
Vo	Output Voltage		-1.0~VDDQ+1.0**	V
PD	Maximum Power Dissipation (VDD)		1180	mW
TOPR	Operating Temperature		0~70	°C
TSTG(bias)	Storage Temperature(bias)		-10~85	°C
TSTG	Storage Temperature		-65~150	°C

Note16.* This is -1.0V when pulse width≤2ns, and -0.5V in case of DC.

** This is -1.0V~VDDQ+1.0V when pulse width≤2ns, and -0.5V~VDDQ+0.5V in case of DC.



mitsubishi LSIs
M5M5V5636GP –16

18874368-BIT(524288-WORD BY 36-BIT) NETWORK SRAM

DC ELECTRICAL CHARACTERISTICS (Ta=0~70°C, VDD=3.135~3.465V, unless otherwise noted)

Symbol	Parameter	Condition	Limits		Unit
			Min	Max	
VDD	Power Supply Voltage		3.135	3.465	V
VDDQ	I/O Buffer Power Supply Voltage	VDDQ = 3.3V	3.135	3.465	V
		VDDQ = 2.5V	2.375	2.625	
VIH	High-level Input Voltage	VDDQ = 3.135~3.465V	0.65*VDDQ	VDDQ+0.3*	V
		VDDQ = 2.375~2.625V			
VIL	Low-level Input Voltage	VDDQ = 3.135~3.465V	-0.3*	0.35*VDDQ	V
		VDDQ = 2.375~2.625V			
VOH	High-level Output Voltage	IOH = -2.0mA	VDDQ-0.4		V
VOL	Low-level Output Voltage	IOL = 2.0mA		0.4	V
ILI	Input Current except ZZ and LBO#	VI = 0V ~ VDDQ		10	μA
	Input Current of LBO#	VI = 0V ~ VDDQ		10	
	Input Current of ZZ	VI = 0V ~ VDDQ		10	
ILO	Off-state Output Current	VI (G#) ≥ VIH, VO = 0V ~ VDDQ		10	μA
ICC1	Power Supply Current : Operating	Device selected; Output Open VI ≤ VIL or VI ≥ VIH ZZ ≤ VIL	6.0ns cycle(167MHz)	340	mA
ICC2	Power Supply Current : Deselected	Device deselected VI ≤ VIL or VI ≥ VIH ZZ ≤ VIL	6.0ns cycle(167MHz)	90	mA
ICC3	CMOS Standby Current (CLK stopped standby mode)	Device deselected; Output Open VI ≤ VSS+0.2V or VI ≥ VDDQ-0.2V CLK frequency=0Hz, All inputs static		20	mA
ICC4	Snooze Mode Standby Current	Snooze mode ZZ ≥ VDDQ-0.2V, LBO# ≥ VDD-0.2V		20	mA
ICC5	Stall Current	Device selected; Output Open CKE# ≥ VIH VI ≤ VSS+0.2V or VI ≥ VDDQ-0.2V	6.0ns cycle(167MHz)	45	mA

Note17.*VILmin is -1.0V and VIHmax is VDDQ+1.0V in case of AC(Pulse width≤2ns).

Note18."Device Deselected" means device is in power-down mode as defined in the truth table.



CAPACITANCE

Symbol	Parameter	Conditions	Limits			Unit
			Min	Typ	Max	
C _I	Input Capacitance	V _I =GND, V _I =25mVrms, f=1MHz			6	pF
C _O	Input / Output(DQ) Capacitance	V _O =GND, V _O =25mVrms, f=1MHz			8	pF

Note19.This parameter is sampled.

THERMAL RESISTANCE

Symbol	Parameter	Conditions	Limits			Unit
			Min	Typ	Max	
θ _{JA}	Thermal Resistance Junction Ambient	TBD		TBD		°C/W
θ _{JC}	Thermal Resistance Junction to Case	TBD		TBD		°C/W

Note20.This parameter is sampled.

AC ELECTRICAL CHARACTERISTICS (Ta=0~70°C, V_{DD}=3.135~3.465V, unless otherwise noted)

(1)MEASUREMENT CONDITION

- Input pulse levels V_{IH}=V_{DDQ}, V_{IL}=0V
- Input rise and fall times faster than or equal to 1V/ns
- Input timing reference levels V_{IH}=V_{IL}=0.5*V_{DDQ}
- Output reference levels V_{IH}=V_{IL}=0.5*V_{DDQ}
- Output load Fig.1

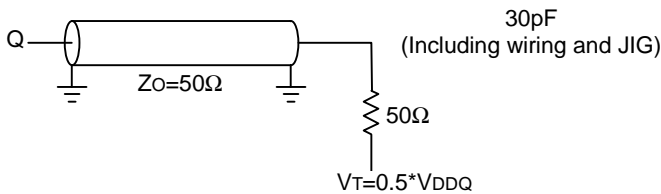

Fig.1 Output load

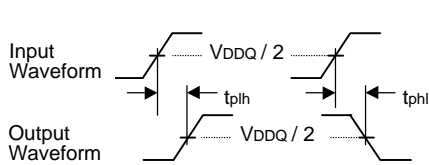

Fig.2 Tdly measurement

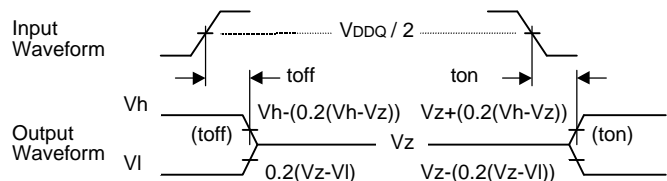

Fig.3 Tri-State measurement

Note21.Valid Delay Measurement is made from the V_{DDQ}/2 on the input waveform to the V_{DDQ}/2 on the output waveform. Input waveform should have a slew rate of faster than or equal to 1V/ns.

Note22.Tri-state toff measurement is made from the V_{DDQ}/2 on the input waveform to the output waveform moving 20% from its initial to final Value V_{DDQ}/2.

Note:the initial value is not VOL or VOH as specified in DC ELECTRICAL CHARACTERISTICS table.

Note23. Tri-state ton measurement is made from the V_{DDQ}/2 on the input waveform to the output waveform moving 20% from its initial Value V_{DDQ}/2 to its final Value.

Note:the final value is not VOL or VOH as specified in DC ELECTRICAL CHARACTERISTICS table.

Note24.Clocks,Data,Address and control signals will be tested with a minimum input slew rate of faster than or equal to 1V/ns.



MITSUBISHI LSIs
M5M5V5636GP –16

18874368-BIT(524288-WORD BY 36-BIT) NETWORK SRAM

(2)TIMING CHARACTERISTICS

Symbol	Parameter	Limits		Unit
		167MHz		
		-16		
		Min	Max	
Clock				
tKHKH	Clock cycle time	6.0		ns
tKHKL	Clock HIGH time	2.0		ns
tKCLKH	Clock LOW time	2.0		ns
Output times				
tKHQV	Clock HIGH to output valid		3.8	ns
tKHQX	Clock HIGH to output invalid	0.8		ns
tKHQX1	Clock HIGH to output in LOW-Z	0.8		ns
tKHQZ	Clock HIGH to output in High-Z	0.8	3.8	ns
tGLQV	G# to output valid		3.8	ns
tGLQX1	G# to output in Low-Z	0.0		ns
tGHQZ	G# to output in High-Z		3.8	ns
Setup Times				
tAVKH	Address valid to clock HIGH	1.5		ns
tceVKH	CKE# valid to clock HIGH	1.5		ns
tadvVKH	ADV valid to clock HIGH	1.5		ns
tWVKH	Write valid to clock HIGH	1.5		ns
tBVKH	Byte write valid to clock HIGH (BWA#~BWd#)	1.5		ns
tEVKH	Enable valid to clock HIGH (E1#,E2,E3#)	1.5		ns
tDVKH	Data In valid clock HIGH	1.5		ns
Hold Times				
tKHAX	Clock HIGH to Address don't care	0.5		ns
tKHckeX	Clock HIGH to CKE# don't care	0.5		ns
tKHadvX	Clock HIGH to ADV don't care	0.5		ns
tKHwx	Clock HIGH to Write don't care	0.5		ns
tKHbX	Clock HIGH to Byte Write don't care (BWA#~BWb#)	0.5		ns
tKHEx	Clock HIGH to Enable don't care (E1#,E2,E3#)	0.5		ns
tKHdX	Clock HIGH to Data In don't care	0.5		ns
ZZ				
tZZS	ZZ standby		2*tKHKH	ns
tZZREC	ZZ recovery		2*tKHKH	ns

Note25.All parameter except tZZS, tZZREC in this table are measured on condition that ZZ=LOW fix.

Note26.Test conditions is specified with the output loading shown in Fig.1 unless otherwise noted.

Note27. tKHQX1, tKHQZ, tGLQX1, tGHQZ are sampled.

Note28.LBO# is static and must not change during normal operation.



MITSUBISHI LSIs M5M5V5636GP –16

18874368-BIT(524288-WORD BY 36-BIT) NETWORK SRAM

(3)READ TIMING

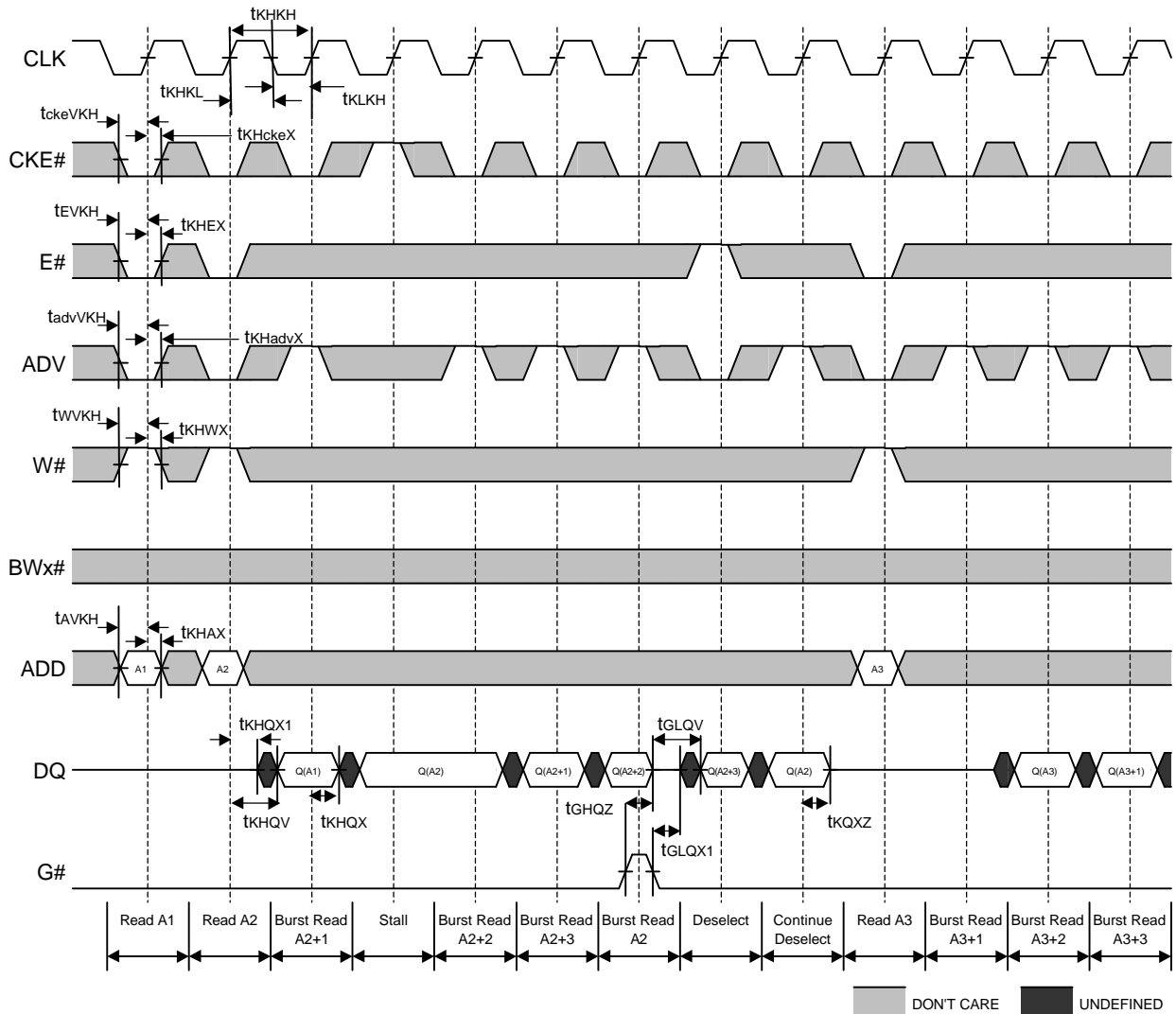

Note29. Q(A_n) refers to output from address A_n. Q(A_n+1) refers to output from the next internal burst address following A_n.

Note30. E# represents three signals. When E# is LOW, it represents E1# is LOW, E2 is HIGH and E3# is LOW.

Note31. ZZ is fixed LOW.



(4)WRITE TIMING

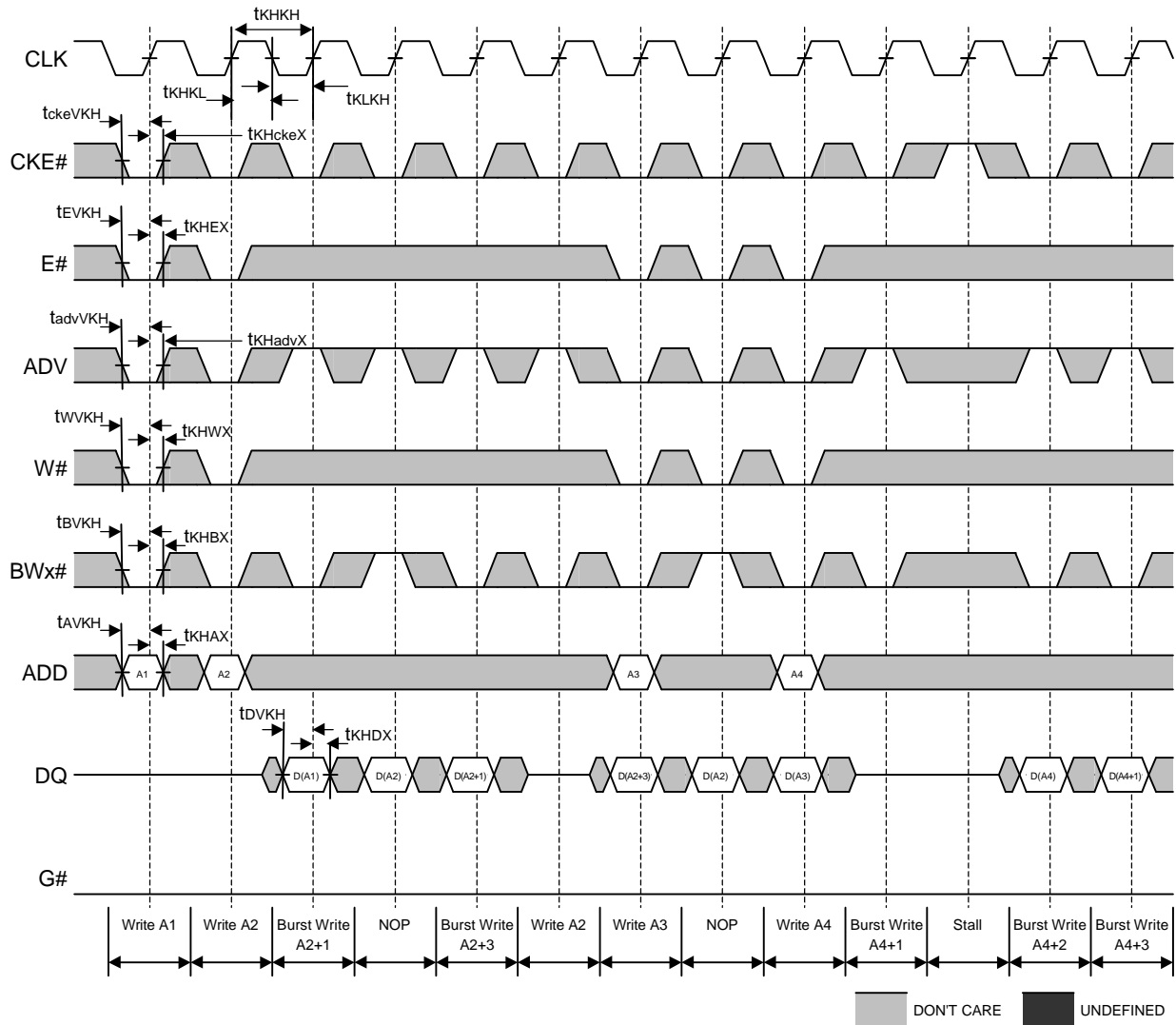

Note32.Q(An) refers to output from address An. Q(An+1) refers to output from the next internal burst address following An.

Note33. E# represents three signals. When E# is LOW, it represents E1# is LOW, E2 is HIGH and E3# is LOW.

Note34.ZZ is fixed LOW.

(5)READ/WRITE TIMING

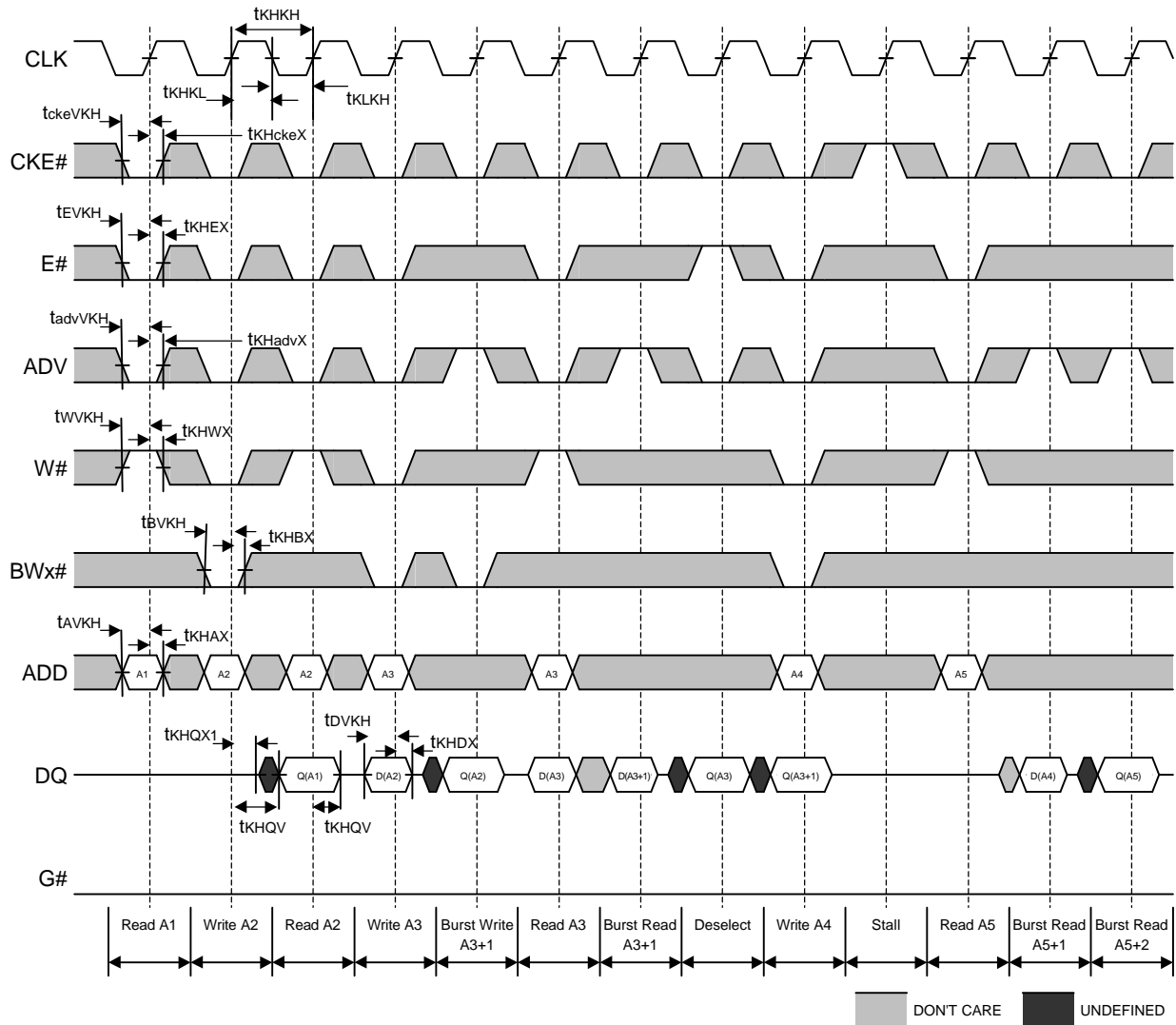

Note35. Q(A_n) refers to output from address A_n. Q(A_n+1) refers to output from the next internal burst address following A_n.

Note36. E# represents three signals. When E# is LOW, it represents E1# is LOW, E2 is HIGH and E3# is LOW.

Note37. ZZ is fixed LOW.

(6)SNOOZE MODE TIMING

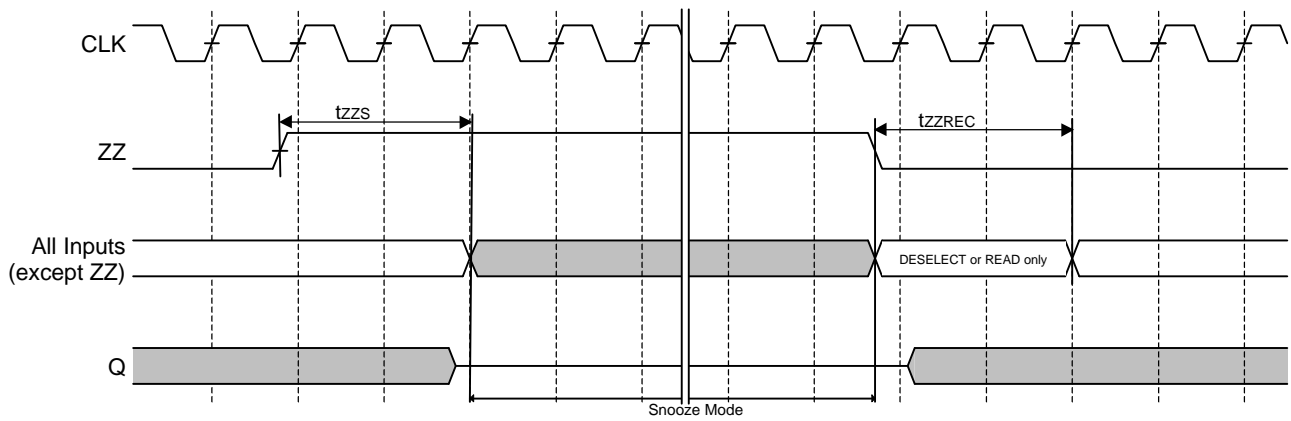

MITSUBISHI LSIs
M5M5V5636GP -16

18874368-BIT(524288-WORD BY 36-BIT) NETWORK SRAM

PACKAGE OUTLINE

Plastic 100pin 14x20 mm body

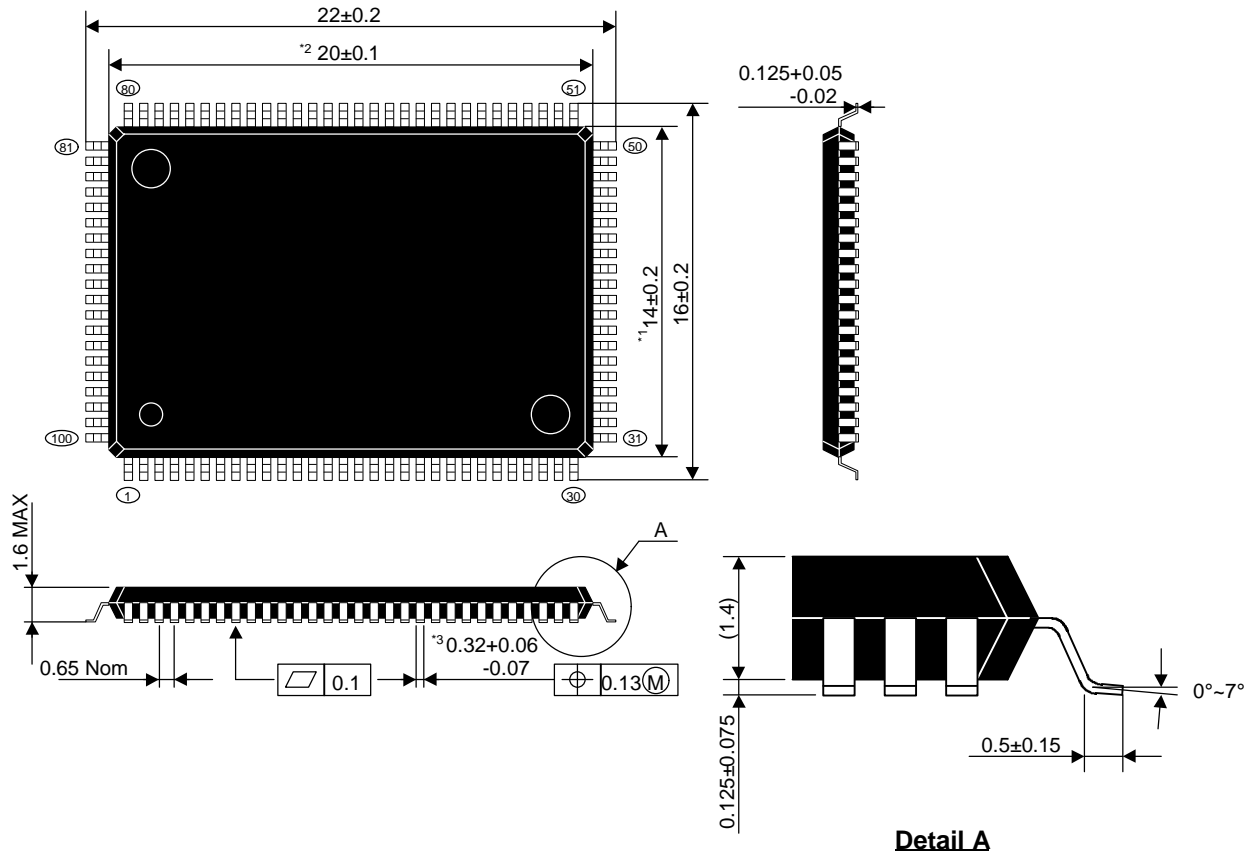

Note38. Dimensions *1 and *2 don't include mold flash.

Note39 Dimension *3 doesn't include trim off set.

Note40.All dimensions in millimeters.

MITSUBISHI LSIs
M5M5V5636GP –16

18874368-BIT(524288-WORD BY 36-BIT) NETWORK SRAM

REVISION HISTORY

- Jun/ 4/2001 REV.0.0 First revision
- Jul/ 16/2001 REV.0.1 Fixed WRITE TRUTH TABLE



Keep safety first in your circuit designs!

●Mitsubishi Electric Corporation puts the maximum effort into making semiconductor products better and more reliable, but there is always the possibility that trouble may occur with them. Trouble with semiconductors may lead to personal injury, fire or property damage. Remember to give due consideration to safety when making your circuit designs, with appropriate measures such as (i) placement of substitutive, auxiliary circuits, (ii) use of non-flammable material or (iii) prevention against any malfunction or mishap.

Notes regarding these materials

●These materials are intended as a reference to assist our customers in the selection of the Mitsubishi semiconductor product best suited to the customer's application; they do not convey any license under any intellectual property rights, or any other rights, belonging to Mitsubishi Electric Corporation or a third party.

●Mitsubishi Electric Corporation assumes no responsibility for any damage, or infringement of any third-party's rights, originating in the use of any product data, diagrams, charts, programs, algorithms, or circuit application examples contained in these materials.

●All information contained in these materials, including product data, diagrams, charts, programs and algorithms represents information on products at the time of publication of these materials, and are subject to change by Mitsubishi Electric Corporation without notice due to product improvements or other reasons. It is therefore recommended that customers contact Mitsubishi Electric Corporation or an authorized Mitsubishi Semiconductor product distributor for the latest product information before purchasing a product listed herein.

The information described here may contain technical inaccuracies or typographical errors. Mitsubishi Electric Corporation assumes no responsibility for any damage, liability, or other loss rising from these inaccuracies or errors.

Please also pay attention to information published by Mitsubishi Electric Corporation by various means, including the Mitsubishi Semiconductor home page (<http://www.mitsubishichips.com>).

●When using any or all of the information contained in these materials, including product data, diagrams, charts, programs, and algorithms, please be sure to evaluate all information as a total system before making a final decision on the applicability of the information and products. Mitsubishi Electric Corporation assumes no responsibility for any damage, liability or other loss resulting from the information contained herein.

●Mitsubishi Electric Corporation semiconductors are not designed or manufactured for use in a device or system that is used under circumstances in which human life is potentially at stake. Please contact Mitsubishi Electric Corporation or an authorized Mitsubishi Semiconductor product distributor when considering the use of a product contained herein for any specific purposes, such as apparatus or systems for transportation, vehicular, medical, aerospace, nuclear, or undersea repeater use.

●The prior written approval of Mitsubishi Electric Corporation is necessary to reprint or reproduce in whole or in part these materials.

●If these products or technologies are subject to the Japanese export control restrictions, they must be exported under a license from the Japanese government and cannot be imported into a country other than the approved destination.

Any diversion or reexport contrary to the export control laws and regulations of Japan and/or the country of destination is prohibited.

●Please contact Mitsubishi Electric Corporation or an authorized Mitsubishi Semiconductor product distributor for further details on these materials or the products contained therein.