

### Features

- Extremely high output voltage
- 2 independently biased magnetic circuits
- Robust housing
- Signal amplitude independent of operating speed
- Screw mounting possible

### Typical applications

- Detection of speed
- Detection of position
- Detection of sense of rotation

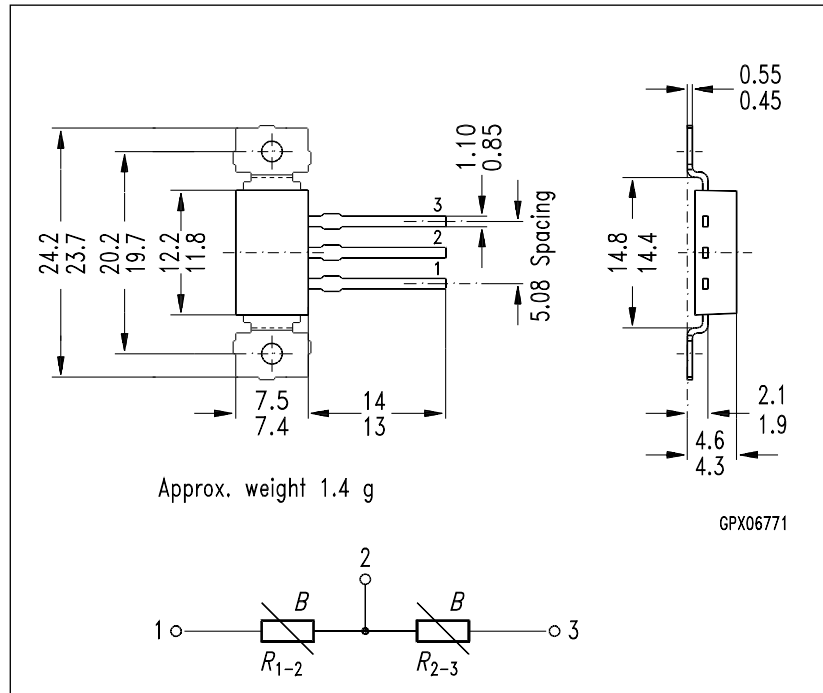

Dimensions in mm

Type	Ordering Code
FP 201 L 100	Q65210-L101

The differential magneto-resistive sensor FP 201 L 100 consists of two magnetically biased magneto resistors made from L-type InSb/NiSb, which in their unbiased state each have a basic resistance of about 125  $\Omega$ . They are series coupled as a voltage divider and are encapsuled in plastic as protection against mechanical stresses. This magnetically actuated sensor can be implemented as a direction dependent contactless switch where it shows a voltage change of about 1.3 V/mm in its linear region.

## Maximum ratings

Parameter	Symbol	Value	Unit
Operating temperature	$T_A$	- 25 / + 100	°C
Storage temperature	$T_{stg}$	- 25 / + 110	°C
Power dissipation <sup>1)</sup>	$P_{tot}$	600	mW
Supply voltage <sup>2)</sup>	$V_{IN}$	10	V
Insulation voltage between terminals and casing	$V_I$	> 100	V
Thermal conductivity	$G_{thcase}$ $G_{thA}$	$\geq 10$ $\geq 5$	mW/K mW/K

## Characteristics ( $T_A = 25\text{ °C}$ )

Nominal supply voltage	$V_{IN N}$	5	V
Total resistance, ( $\delta = \infty, I \leq 1\text{ mA}$ )	$R_{1-3}$	700...1400	$\Omega$
Center symmetry <sup>3)</sup> ( $\delta = \infty$ )	$M$	$\leq 10$	%
Offset voltage <sup>4)</sup> (at $V_{IN N}$ and $\delta = \infty$ )	$V_0$	$\leq 130$	mV
Open circuit output voltage <sup>5)</sup> ( $V_{IN N}$ and $\delta = 0.5\text{ mm}$ )	$V_{out pp}$	> 2.2	V
Cut-off frequency	$f_c$	> 7	kHz

This sensor is operated by a permanent magnet. Using the arrangement as shown in **Fig. 1**, the permanent magnet increases the internal biasing field through the righthand side magneto resistor (connections 2-3), and reduces the field through the left side magneto resistor (connections 1-2). As a result the resistance value of  $MR_{2-3}$  increases while that of  $MR_{1-2}$  decreases. When the permanent magnet is moved from left to right the above-mentioned process operates in reverse.

1) Corresponding to diagram  $P_{tot} = f(T_{case})$

2) Corresponding to diagram  $V_{IN} = f(T)$

3)  

$$M = \frac{R_{1-2} - R_{2-3}}{R_{1-2}} \times 100\% \text{ for } R_{1-2} > R_{2-3}$$

4) Corresponding to measuring circuit in **Fig. 3**

5) Corresponding to measuring circuit in **Fig. 3** and arrangement as shown in **Fig. 2**

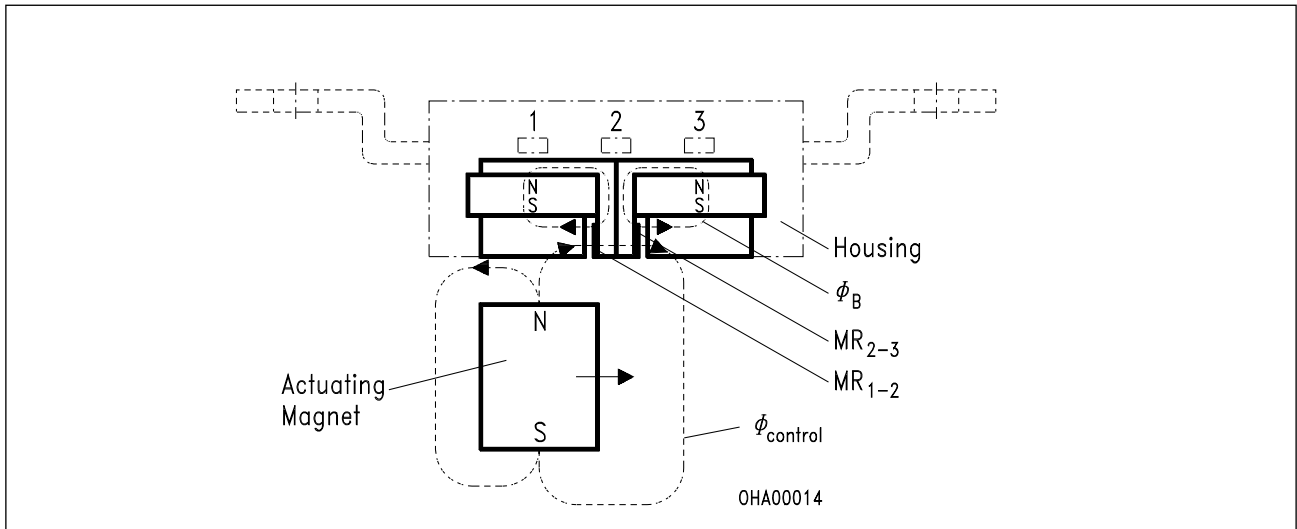

**Fig. 1**  
Sensor operating by external permanent magnet

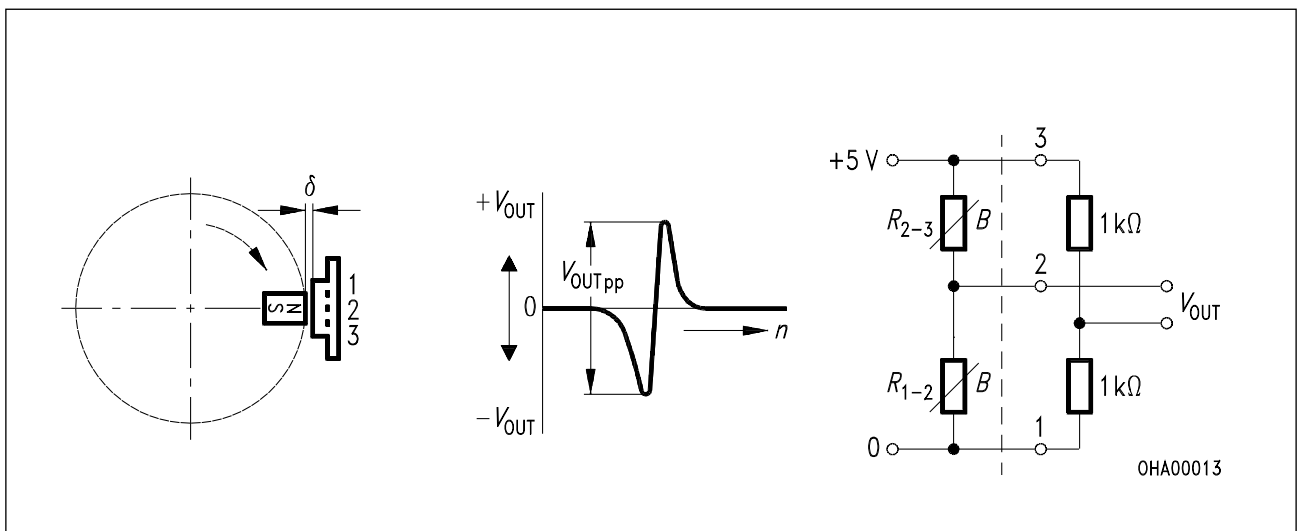
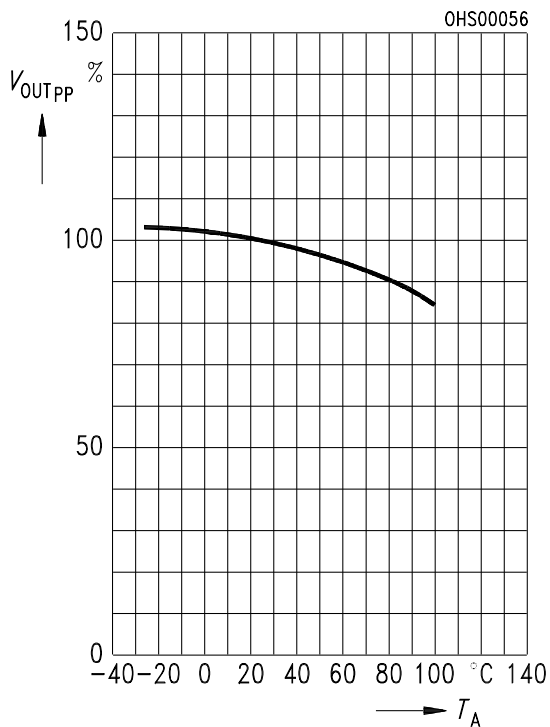

**Fig. 2**  
Measuring arrangement with a permanent magnet Alnico 450  
Ø = 4 mm, 6 mm long

**Fig. 3**  
Measuring circuit and output waveform

A steeper gradient is achieved when using a horseshoe magnet.

**Output voltage (typical) versus temperature**  $V_{OUTpp} = f(T_A)$ ,  $\delta = 0.5 \text{ mm}$   
 $V_{OUTpp}$  at  $T_A = 25 \text{ }^\circ\text{C} \hat{=} 100\%$



**Output voltage (typical) versus airgap**  $V_{OUTpp} = f(\delta)$ ,  $T_A = 25 \text{ }^\circ\text{C}$   
 $V_{OUTpp}$  at  $\delta = 0.5 \text{ mm} \hat{=} 100\%$

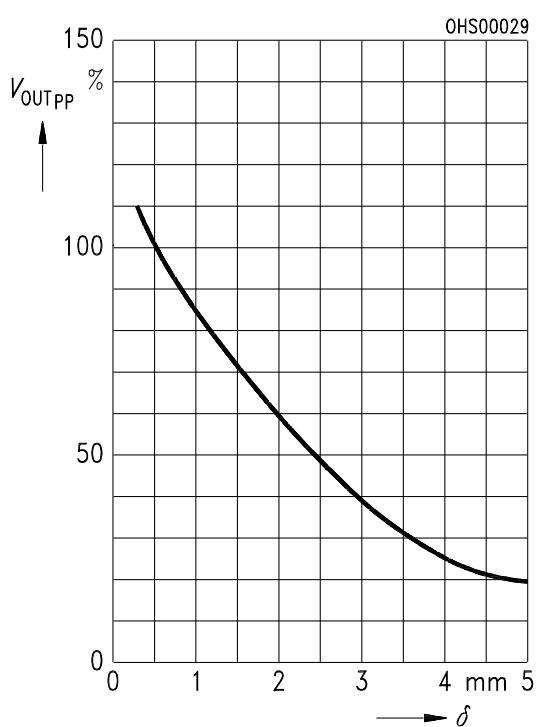

**Total resistance (typical) versus temperature**  
 $R_{1-3} = f(T_A)$ ,  $\delta = \infty$

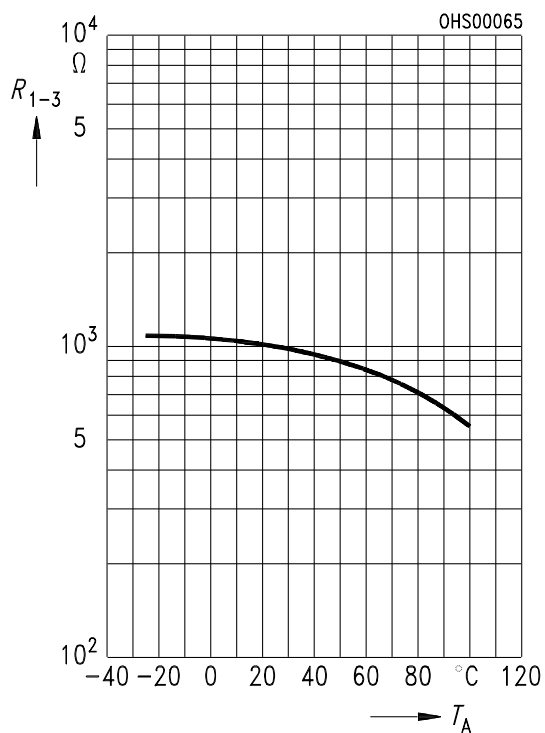

**Max. power dissipation versus temperature**  
 $P_{tot} = f(T)$ ,  $\delta = \infty$ ,  $T = T_{case}$ ,  $T_A$

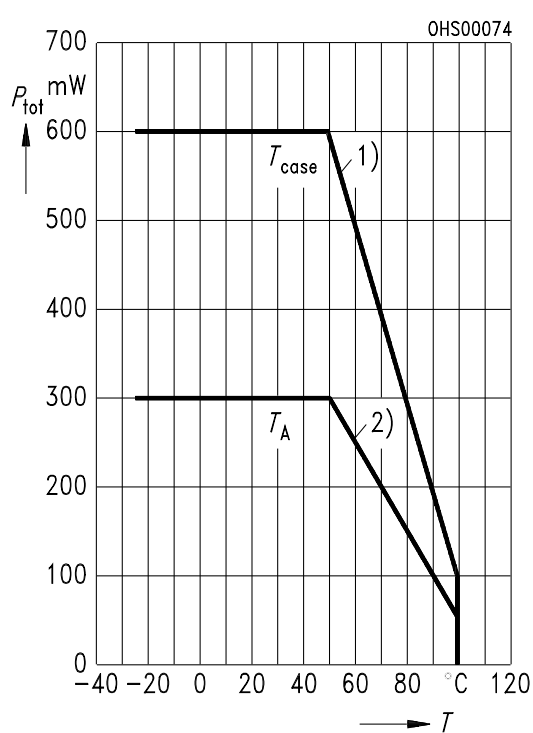

## Maximum supply voltage versus temperature

$$V_{IN} = f(T), \delta = \infty, T = T_{case}, T_A$$

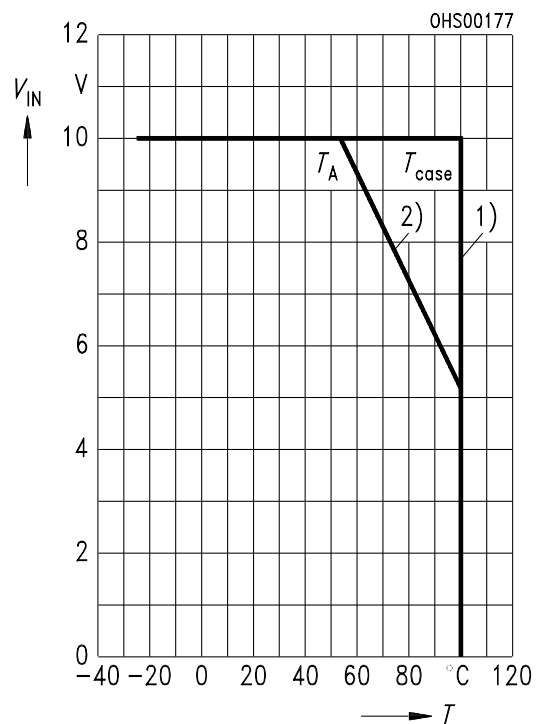

- 1) Sensor mounted with good thermal contact to a heat sink
- 2) Operation in still air