

1.0 GENERAL DESCRIPTIONS

The MX93021 is an engine chip for Digital-Answering-Machine.

The MX93021 provides functional modules, including speech compression/decompression, telephone line signal processing, ROM voice prompt, ARAM management.

Controlled by host, the MX93021 provides the interface with host , memory , and codec, etc.

The MX93021 is especially suitable for cordless answering phone or the FAX built-in answering machine function because the MX93021 supports extend I/O space so as to reduce the overhead of the host processor.

2.0 FEATURES

- 4.8K bps compression rate.
- Maximum 8 Personal Mail Supports (Separate 63 ICM)
- DTMF generation and detection with near-end echo cancellation.
- Voice Prompt ROM support
- 8-bit host interface
- ICM management
- Time keeping
- Extended I/O supporting
- Reserve up to 2K words space for data storage

3.0 BLOCK DIAGRAM

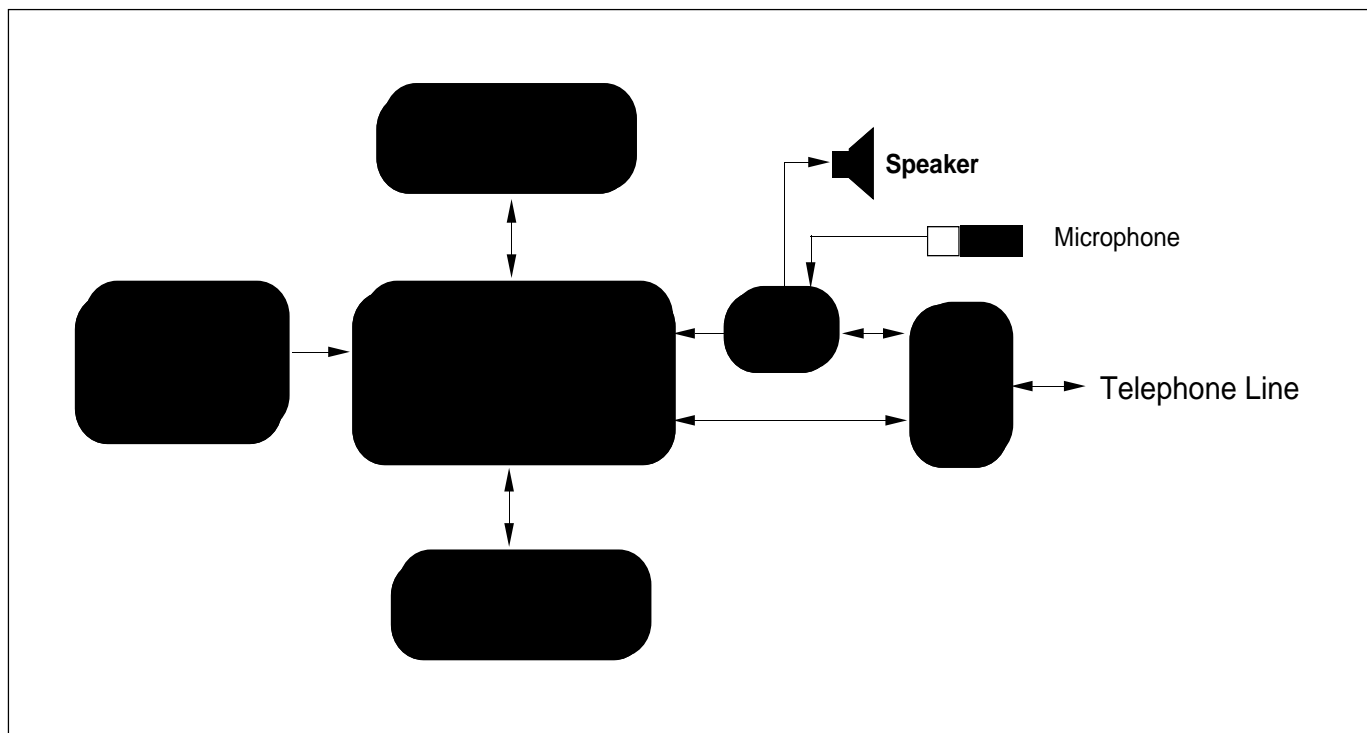

4.0 PIN CONFIGURATIONS (PIN.GEM)

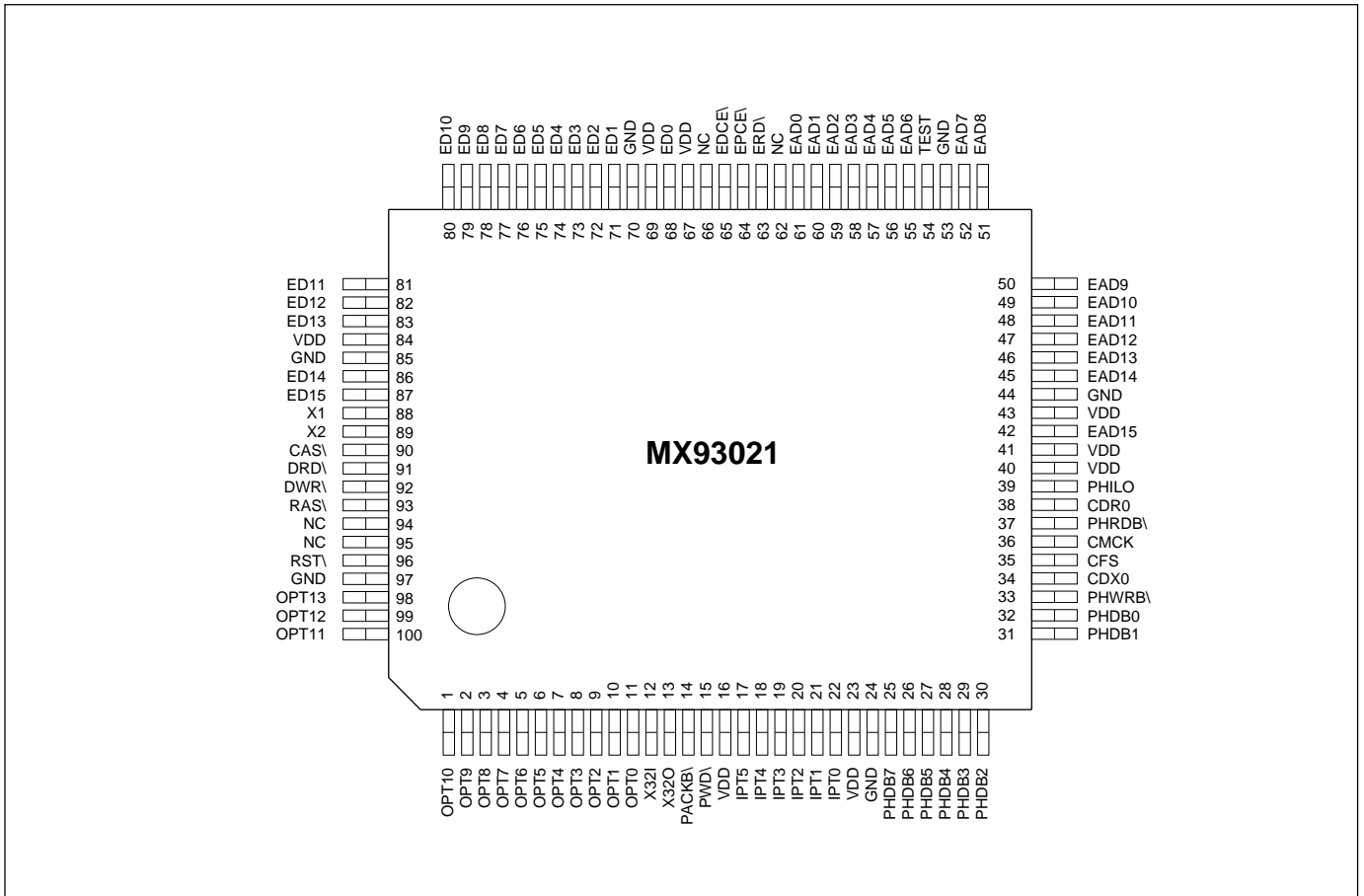

5.0 PIN DESCRIPTIONS

SYMBOL	PIN TYPE	PIN NUMBER	DESCRIPTION
VDD		16, 23, 43, 69, 84,67,40,41	5V power source
GND		24, 44, 53, 70, 85,97	Ground
X1		88	Crystal input
X2		89	Crystal output
RST\	I	96	Power-on Reset, Schmite-triggered
X32O	OA	13	32k Crystal output.
X32I		12	32k Crystal input.
TEST	I	54	Connect to VDD
PWD\	I	15	AC. Power Condition

5.0 PIN DESCRIPTIONS *(Continued)*

SYMBOL	PIN TYPE	PIN NUMBER	DESCRIPTION
EAD0-EAD15	OB	61-55, 52-45, 42	DSP ROM address bus. EAD0-EAD14 are also for DRAM address .
ED0-ED15	I/OB	68, 71-83, 86-87	DSP ROM/DRAM data bus.
EDCE\	OB	65	RAM/VOP Voice prompt ROM chip enable.
EPCE\	OB	64	ROM chip enable.
ERD\	OB	63	ROM external read.
CAS\	OB	90	DRAM column address select.
RAS\	OB	93	DRAM row address select.
DRD\	OB	91	DRAM read.
DWR\	OB	92	DRAM write.

uP INTERFACE

SYMBOL	PIN TYPE	PIN NUMBER	DESCRIPTION
PHILO	I	39	High- or low-byte select
PHRDB\	I	37	Host read
PHWRB\	I	33	Host write
PHDB(7:0)	B	25~32	Host data bus
PACKB\	OA	14	Data is ready

5.0 PIN DESCRIPTIONS (Continued)**CODEC (4 PINS)**

SYMBOL	PIN TYPE	PIN NUMBER	DESCRIPTION
CFS	OB	35	Codec frame sync, 8 KHz. (6KHz)
CMCK	OB	36	Codec master clock, 1.536 MHz (default output).
CDX0	OA	34	Codec data transmit
CDR0	I	38	Codec data receive

OPT:Output port (14 PINS)

SYMBOL	PIN TYPE	PIN NUMBER	DESCRIPTION
OPT0 - OPT13 OC		1-11, 98, 99,100	Output to pin, all output values are registered and may be read back when read by "IN" instruction.

IPT:Input port (6 PINS)

SYMBOL	PIN TYPE	PIN NUMBER	DESCRIPTION
IPT0 - IPT5	I	17-22	IPT0 - IPT3 have internal pull up resistor 32K Ω IPT4, IPT5 connect to GND if they are not used.

NOTE:OA=4mA, OB=4mA, OC=16mA output current.
Symbol with backslash or bar is low active.

6.0 FUNCTIONAL DESCRIPTIONS

HOST INTERFACE

The host interface port is a 16-bit bidirectional register. The host can access this register via PHDB(7:0) pins in two accesses selected by PHILO pin. When the host sets PHILO to low the host writes the low byte of the command to the register of DSP, and DSP does nothing but latches the data: While host sets PHILO to high, the host writes the high byte of the command to the register and then DSP fetches the content of the register. PACKB\ is defaultly set to high. When DSP writes a response to this register, PACKB\ is set to low. When host has read this register, PACKB\ will be reset to high. Note that the host accesses this register by low byte first, and then high byte.

ARAM MANAGEMENT

ARAM types and specifications supported by the MX93021 are as follows:

1. ARAM type :

- 64K x 16
- 128K x 8, 128K x 16
- 256K x 4, 256K x 8, 256K x 16
- 512K x 2, 512K x 4, 512K x 8, 512K x 12, 512K x 16
- 1M x 1, 1M x 2, 1M x 4, 1M x 8, 1M x 12, 1M x 16
- 2M x 1, 2M x 2, 2M x 3, 2M x 4, 2M x 8, 2M x 12, 2M x 16
- 4M x 1, 4M x 2, 4M x 3, 4M x 4, 4M x 8, 4M x 12, 4M x 16
- 8M x 1, 8M x 2, 8M x 3, 8M x 4, 8M x 8, 8M x 12, 8M x 16
- 16M x 1, 16M x 2, 16M x 3, 16M x 4, 16M x 8, 16M x 12, 16M x 16

2. 4M bits & larger density ARAM specifications :

- ARAM speed is not less than 120 ns.
- ARAM refresh use CAS-BEFORE-RAS mode.
- The number of column address line is greater than or equal to 4.
- There are no failed bit in first 16 rows.
- ARAM is separated to 16384 clusters, one bit of one cluster being failed will be a bad cluster, and total bad clusters are less than 25% of total clusters.
- DC/AC characteristics are the same as those of standard DRAM.
- Maximum input/output leakage current is 2 uA.
- Maximum stand-by current is 2mA.

Voice Message Recording and Storage

The MX93021 provides a high quality 4.8 kbps speech compression technique to permit over 14 minutes of speech storage in each 4M bit of DRAM device.

The chip supports up to 63 variable length incoming and outgoing messages that are labeled as Msg ID 1 to 63. Although ICM could range from Msg 1 to 63, Msg IDs 63 to 57 are the only places for outgoing messages (OGM) storage so that the deletion and recovery of old OGM are easier to maintain. The Msg IDs of incoming messages are labeled chronologically and rearranged automatically after recording or deleting. ICM with Msg ID 1 is the oldest recorded incoming message.

During recording, the MX93021 also monitors the telephone line signal to detect the presence of DTMF, Call progress Tone and Continuous Tone and responses to the HOST. The HOST can stop recording, and delete the last n*400 ms from the memory using a Record Pause command with assigned Tail Cut Factor.

The MX93021 can generate a desired tone during recording voice message, which allows the application such as two-way recording. During recording, Record Pause function is provided.

The recording voice signal, received through the CODEC input, is transmitted back to the CODEC output by the MX93021.

Announcement (ANNC) Record

The MX93021 provides flexible recording ways for outgoing message. The HOST can select to delete the old ANNC before a new one is recorded or to abort the new ANNC record without losing the old ANNC.

New/Old Message

For the HOST to manipulate incoming messages more handily, the MX93021 keeps an internal record of the ICM to identify the new/old status of messages.

Before playback, the status of ICM is considered as "new". All incoming messages that have been played could change their status to "old" by issuing Real Del bit on PLAY command. After Real Del is issued, all new/old ICM Msg IDs will be rearranged. The functions, Play-new or Delete-all-old messages, are provided by the MX93021 in the command set.

Message Playback

Random access for playback of any new message or message with specified Msg ID is supported by the MX93021. During playback, the MX93021 also monitors the telephone line signals, and Play Pause function is provided. The MX93021 is able to fast-forward the playback of a recorded message, and the playing speed will be up to 33%.

Message Deletion

The MX93021 provides two ways to delete recorded ICMs. One is the two-step method -- the combination of Del Mark and Real Del on Play command, and the other is the immediate method -- Delete command. The two-step method enables the HOST to handle the deletion more flexibly, while the immediate method deletes a specified message directly.

Voice Prompt

For high-quality Voice Prompt playback, the MX93021 utilizes the built-in speech decoder and an external EPROM/ROM (minimum access time is 120ns) to store the vocabulary. The chip supports up to a 62-Kword EPROM/ROM that allows 3.44 minutes of voice prompts storage. The vocabulary supports up to 255 phrases. Given a phrase number in the Voice Prompt command from the HOST, the MX93021 outputs the corresponding utterances to the Codec interface.

The starting address of voice prompt data could be located at address 800hex, 4800hex, or 8000hex.

During playback of the voice prompt, the MX93021 monitors the telephone line signals.

Time Keeping

There is a timer clock in the MX93021. The HOST can issue Set Time and Get Time commands to get time services. The clock also supports system to stamp time to the recorded incoming messages.

DTMF Detection

For remote control operation of the answering machine, the MX93021 monitors the incoming telephone line signal to detect the presence of DTMF signal.

Tone Generation

Up to double tones can be generated by the MX93021. The levels and frequencies are programmable by the HOST.

Call Progress Tone Detection

The MX93021 supports the detection of call progress tones within the band of 330-660 Hz for the incoming telephone line signal. The tone detector is implemented with a bandpass filter. Indication of the presence of call progress tones is responded to the HOST, and could be used to terminate recording.

Near End Echo Cancellation

The MX93021 implements a near end echo canceller in software to enhance the detection of DTMF and Call Progress Tone during Playback and Voice Prompt mode.

Vox Detection (Digital Voice Activated Recording)

The speech detection is implemented in the DAM chip to indicate whether the recording signal level is above the Vox threshold. If the HOST sets the Vox Record bit on Initial command, the recording of the speech would start when the voice activity is detected. The HOST has to set Vox threshold by issuing command mode 13. Hexadecimal numbers for Vox threshold are listed in Table VII.

Query and Report

The MX93021 is capable of reporting to the HOST about the query of the current status, such as the number of recorded messages, the number of new messages, the number of old messages, the available recording time of ARAM, the time of recorded message, and the ARAM good/bad check.

Personal Mail

The MX93021 supports up to 8 mailboxes that may be used for personal mail application. Each mailbox has its own ICM/MEMO Msg ID. Before recording or playing messages, the HOST should set the corresponding mailbox number first with Personal Mail command.

Speed Dial Telephone Number Storage

The MX93021 may store up to 2048 words for telephone number storage. The 2048 words of memory in ARAM area could be also used for other special purpose, and are backed up during power down mode.

Power Down

With the power of backup batteries, the MX93021 is capable of keeping messages and data stored in the ARAM during power failure. In power down mode, the MX93021 will run at a lower clock rate to reduce power consumption and keep refreshing the ARAM.

7.0 OPERATION DESCRIPTION

INITIAL PROCEDURE

When the system is powered up, the input PWD\ (pin 15) signal should go high followed by the input RST\ (pin 96) pulse that should be low at least 10 ms long. The checksum of ARAM and internal SRAM will be calculated and stored before entering power-down mode. After power up, the MX93021 identifies itself to be in cold or warm stage by comparing the system checksum and responds to each situation as follows:

1. The system checksum remains unchanged -- warm start, which means messages in ARAM and data in internal SRAM are kept correct by backup batteries during power down. In this case, the MX93021 restores all the previous conditions and system parameters.
2. The system checksum is changed -- cold start, which means the messages and data have been lost before the system is powered up. Then, the MX93021 will initialize all the system parameters to their default values.

After completing the above system initialization, the MX93021 will send its status of warm/cold start to the HOST, set ACK\ to low and enter Idle mode. The HOST should poll the ACK\ to read the status word, 0000h for cold start and 0100h for warm start.

After being reset, the MX93021FC will first do self test and initialization, then it will set pin-14 (PACKB\) low to indicate host processor. But before the signal (PACKB\ setting to low) appears, there will be a pulse about 6us shown up in pin-14. Host processor should ignore that pulse. Please see detailed in the following timing diagram.

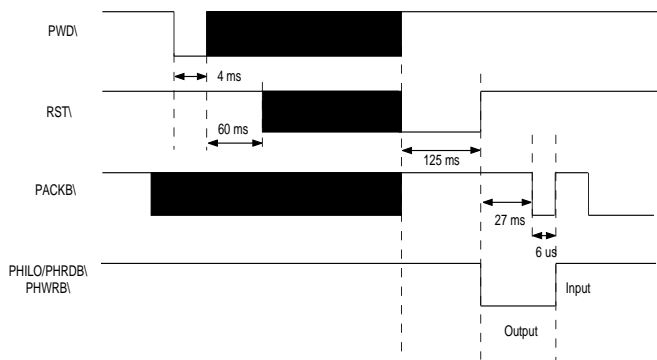

MODES OF OPERATION

After reset, the MX93021 is normally in Idle mode and keeps polling command from the HOST. When a command is issued by HOST, the system will enter the new mode. For some of the mode, the system will return to Idle mode after operation is completed. While other modes, Record, Playback, Line Monitor and Voice Prompt, require Stop command to return to Idle mode.

The MX93021 supports 14 modes of operation, that are listed as follows:

Command	Mode Name
1	Record
2	Play
3	Message status
4	Tone Generation
5	Line Monitor
6	Delete Message
7	Set Current Time & OPT
8	Get Current Time & OPT & IPT
9	Initial & Test Memory
10	Get Record Message Time
11	Voice Prompt
12	Voice Activity
13	Personal Mail
14	Telephone Number

DESCRIPTION OF MODES OF OPERATION

Record

When Record command is received from the HOST, the MX93021 performs speech compression, stores the message into ARAM, and monitors telephone line. If the Vox Record bit had been set to 1 on Initial & Test command, recording of the speech will start upon the voice activity detected, else the MX93021 starts recording immediately after Record command is received.

Clearing Marked Record (bit 8-10) to 0, if it is recording ICM. When recording OGM, the HOST should set Marked Record (bit 8-10) to desired number other than 0 as OGM ID.

Setting bit 5 (Annc Del) to 1 on Initial & Test command, the HOST can choose to delete the old announcement before a new one is recorded. If that bit is cleared to 0, the new announcement recording can be aborted without losing the old announcement by issuing Mark Fail (bit 11) on Record command.

During recording, the HOST can pause the recording by setting Pause (bit 7) to 1 and resume recording by clearing that bit. Line Monitoring will continue during pause.

The HOST can stop recording by setting Stop (bit 6) to 1, and delete the last $n \times 400$ ms from the memory by using a Record command with assigned Tail Cut Factor (bit 0-5).

While system memory is full, the MX93021 will stop message recording, show the status in response word (bit 7, Mfull), not perform line monitoring, but still remain in Record mode.

During Record mode, the HOST can instruct the MX93021 to generate a tone by issuing the Tone generation command. Setting Stop bit on Tone Generation command or Record command will stop tone generating.

In recording, all commands will be ignored except Record, Get Time & OPT & IPT, Set Time & OPT and Tone Generation.

The MX93021 will terminate Record mode and return to Idle mode when Stop bit on Record command is set to 1.

Note: The MX93021 supports up to 63 incoming and outgoing messages recording which are labeled as Msg

ID 1-63. The Msg IDs of incoming message are labeled chronologically and rearranged automatically after recording. Although ICM could range from Msg 1 to 63, Msg IDs 63 to 57 are the only place for outgoing message storage. So, it is strongly suggested that the HOST should keep an upper bound of the number of ICM. (For example, upper bound of ICM=63 - maximum OGM number that will be applied in user's specification.)

Play

When Play command is received from the HOST, the MX93021 performs message playback and line monitoring. The Msg ID (bit 0-5) is set by the HOST to specify which message to play. To playback new message (non-played one), set Play New (bit 10) to 1, then the MX93021 will search to play the non_played message with specified Msg ID. During playing, the HOST can pause playback by setting Pause (bits) to 1 and resume playing from the same point by clearing that bit. Line Monitoring will continue during pause. To fast playback a recorded message, set Fast Play (bit 11) to 1 and the playing speed will be up to 33%.

To delete and stop the playing message, the HOST can set Del Mark (bit 6) on play command. After being tagged a Del Mark, the marked message is not really deleted until a Real Del (bit 7) is set. The Real Del command not only deletes the messages that have been tagged a Del Mark but also changes the status of those ICMs that have been played to old. The ICMs that have not been played before are regarded as "new". After Real Del is issued, all new/old ICM Msg IDs will be rearranged.

For the HOST, it is used to issuing the Real Del after the user terminates the manner of playback.

The response word contains the information of tones detected from the line, playing time spent (bit 8-15) and End of play flag (bit 6), which indicates the end of the current message. When the Play_End bit is 1, the MX93021 stops playback but still remains in Play mode.

The MX93021 will response to the Play_End flag if the HOST wants to play invalid or nonexistent messages.

In playing, all commands will be ignored except Play, Get Time&OPT&IPT, and Tone Generation.

The MX93021 will terminate Play mode and return to Idle mode when Stop bit, Del Mark bit or Real Del bit is set to 1 on Play command.

Message status

In this mode, there are four request codes for the HOST to get message information:

1. Get the number of recorded message (request code=0)
2. Get the number of new message (request code=1)
3. Get the number of old message (request code=2)
4. Get the available recording time with unit of second (request code=3).

The result will be reported in the response word.

Tone Generation

In this mode, up to double tones can be generated by the MX93021. The tone levels and frequencies are programmable and controlled by the HOST. All the parameters are defined by the sequence of three Tone Generation commands. The first command defines the output gains in bit 0-3 for the 1st tone, and bit 4-7 for the 2nd tone. Each tone can be programmed from 0 dB (gain code 0000) to -28 dB (gain code 1110) with 2 dB resolution. The frequencies are defined in the second and third commands with the following relationship:

frequency code=desired frequency (Hz) *8.19
 $f(n)=32767*\cos(2*\pi*f_code*n/(8000*8.19))$
 where f_code is the input frequency code, n is sequence index and 8000 is the sampling rate

For single tone, Codec outputs the signal s(n):

$$s(n)=gain*f(n)$$

For dual tone, Codec outputs the signal s(n):

$$s(n)=0.5*(gain1*f1(n)+gain2*f2(n))$$

To generate a single tone, the gain code of the other tone should be set to 1111. The MX93021 starts tone generation only after receiving the third command.

The MX93021 will terminate Tone Generation when Stop bit is set to 1 on Tone Generation command.

Line Monitor

In this mode the MX93021 monitors the telephone line signal for the detection of DTMF, Call Progress Tone, Vox, and/or Continuous Tone. The MX93021 keeps monitoring the line until Stop bit is set to 1.

The MX93021 returns to the HOST a response word that reflects the flag of Call Progress Tone, Vox, Continuous Tone and the index of DTMF signal that has been detected:

INDEX	DTMF CODE
0	No Tone
1	1
2	2
3	3
4	4
5	5
6	6
7	7
8	8
9	9
A	*
B	0
C	#

The MX93021 will terminate Line Monitor mode and return to Idle mode when Stop bit is set to 1 on Line Monitor command.

Delete Message

This mode provides an immediate way to delete messages as follows:

1. To delete a specified message, set its Msg ID in bit 0-5 and clear bit 11, 10 and 7 to zero.
2. To delete all old ICM, set Del_All_Old (bit 7) to 1 and clear bit 11, 10 to zero. (Bit 0-5 is ignored)
3. To delete a specified new ICM, set Del_New_Msg (bit 10) to 1, give the New Msg ID in bit 0-5, clear bit 11, 7 to zero.
4. To erase the Del Mark from a specified ICM (Del Mark is a tag set on Play command for real deletion), set Del_Mark_Clr (bit 11) to 1, give the Msg ID in bit 0-5 and clear bit 10, 7 to zero.

If the HOST deletes invalid or nonexistent messages, an error flag will show on bit 0 of the response word.

Set Current Time & Output Port

In this mode the HOST can set the current time to the internal timer clock of the MX93021. The time information includes second, minute, hour and week. The timer in the MX93021 will be used to stamp time and data to the recorded message.

- 1.To set second, put the data in bit 0-7 and use request code(bit 8-11) 0000.
- 2.To set minute, put the data in bit 0-7 and use request code(bit 8-11) 0001.
- 3.To set hour, put the data in bit 0-7 and use request code(bit 8-11) 0010.
- 4.To set week, put the data in bit 0-7 and use request code(bit 8-11) 0011.
- 5.To set OPT 0-7, put the output data in bit 0-7 and use request code(bit 8-11) 0100.
- 6.To set OPT 8-13, put the output data in bit 0-7 and use request code(bit 8-11) 0101.

Get Current Time, Output Port & Input Port

In this mode the HOST can get the current time from the internal timer clock of the MX93021. The time information includes second, minute, hour and week.

- 1.To get second, use request code (bit 8-11) 0000.
- 2.To get minute, use request code (bit 8-11) 0001.
- 3.To get hour, use request code (bit 8-11) 0010.
- 4.To get week, use request code (bit 8-11) 0011.
- 5.To get OPT 0-13, use request code (bit 8-11) 0100.
- 6.To get OPT 0-13, use request code (bit 8-11) 0101.
- 7.To get IPT 0-5, use request code (bit 8-11) 0110.

The requested data will be reported in the response word.

Initial & Test Memory

In this mode there are 6 functions for the HOST to define:

1.ARAM Initialization

The HOST can initialize the ARAM by setting Init ARAM (bit 0) to 1. This function is normally used after first power-up of the system. The HOST must send this command to the MX93021 in order to format ARAM. The MX93021 performs ARAM formatting to determine the ARAM size (address space and bit width) and detect the good/bad memory unit of ARAM. The response word reported to the HOST contains the information of ARAM bit size (bit 0-3), ARAM address size (bit 4-7) and ARAM good/bad status (bit 8). If the examination in the initialization shows that the ARAM quality meets the pre-defined specification, the MX93021 responses 1 in ARAM good/bad status bit. After initialization, all messages in the ARAM are lost.

2.ARAM Pattern Check

The MX93021 allows the HOST to check the status of ARAM by setting the ARAM Check (bit 1) on this command. By checking the patterns, produced in Initialization ARAM mode and stored in ARAM, the MX93021 can identify the current ARAM status to be good or bad.

3.Line On/Off

The HOST should set Line-On (bit 3) to 1 if the system is logged in from telephone line; and clear that bit to 0 if in local keypad operation. Failing to set this bit properly will degrade the performance of echo cancellation.

4. Vox On/Off Record

If the HOST turns on the Vox Record function (by setting bit 4 to one) on this command, speech recording will start upon the voice activity detected, else recording will start immediately after Record command is issued.

5.Announcement Deletion

By setting bit 5 (Annc Del) to 1 on this command, the HOST can choose to delete the old announcement before recording a new one. If that bit is cleared to 0, the old announcement is not deleted until the new announcement recording is completed. With this option, the new announcement recording can be aborted without losing the old announcement by issuing Mark Fail (bit 11) on Record command.

6. Word/Byte

The Word/Byte (bit 8) defines the way that the MX93021 accesses voice prompt data. By setting this bit to 1, the voice prompt data is accessed by the MX93021 with the unit of word, else with the unit of byte.

Get Record Message

In this mode, there are nine request codes for the HOST to get the related information about a specified message.

Given the Msg ID (bit 0-6) and New_Msg flag (bit 7), the MX93021 can provide message recording time, recording length, attribute and Del Mark status according to the Request Code (bit 8-11) as follows:

1. Get the recording time -- second. (Request Code = 0000)
2. Get the recording time -- minute. (Request Code = 0001)
3. Get the recording time -- hour. (Request Code = 0010)
4. Get the recording time -- week. (Request Code = 0011)
5. Get the recording length (sec). (Request Code = 0100)
6. Get the timer status. (Request Code = 0101)
The response word is 1 if the MX93021 internal timer has been set before with Set Current Time command. Otherwise, the response word is 0.
7. Get the message attribute. (Request Code = 0110) To show the specified message is of MEMO type (*response word = 1) or ICM type (response word = 0)
8. Get the Del Mark status. (Request Code = 0111) To show the specified message has been tagged a Del Mark (response word = 1) or not (response word = 0)
9. Check OGM existence. (Request Code = xxxx) This submode command works only when the memory specified by the Msg ID is exclusively for OGM storage. Use this command to show whether an OGM with the Msg ID is recorded (response word = 1) or not (response word = 0).

All the results are reported in the response word.

Voice Prompt

In this mode the MX93021 plays back a speech segment that the corresponding phrase number is given in command bit 0-7. Up to 255 speech segments, previously stored in an external ROM/EPROM, are provided by the MX93021 and pronounced using the speech decompression algorithm. The HOST can pause the playback by setting PS (bit 8) to 1 or resume from pause by clearing PS bit to 0. Fast forward playback of voice prompt is also provided by setting Fast Play (bit 11) to 1. During voice prompt generation mode, the MX93021 keeps monitoring the line signal and sends the results in response word to the HOST.

The MX93021 will terminate Voice Prompt Generation mode and return to Idle mode when Stop bit is set to 1 on Voice Prompt Generation command.

Voice Activity

In this mode the HOST can set the VOX threshold in bit 0-11. The Hexadecimal numbers for VOX level are listed in Table VII.

Personal Mail

Two functions are provided in this command as follows:

1. Set the personal mailbox number
In this mode the HOST can select one out of eight mailboxes (setting in bit 0-2) for recording messages, playing recorded message and retrieving message time. Each mailbox manages its own messages and Msg IDs. The default mailbox is number 0.
2. Set the recording message attribute
Before recording a message, the HOST can set the attribute of that message to be MEMO or ICM. Clear bit 3 to zero for recording a message as an ICM or set bit 3 to one for recording a message as a MEMO.

Make sure to set the desired mailbox before issuing the message related commands such as Record, Play, Delete Message and Get message Time.

Telephone Number

In this mode the HOST can write/read telephone number to/from the MX93021 with the sequence of Telephone Number commands as follows:

1. Write telephone number to the MX93021.

The first command defines the telephone directory index (bit 0-10) and W/R (bit 11). The second command specifies the one-word data to be stored under that index.

2. Read telephone number from the MX93021.

The command defines the telephone directory (bit 0-10) and W/R (bit 11). The telephone data will be shown on the response word.

HOST INTERFACE PERFORMANCE

Power-Down

To keep the ARAM and internal RAM data correct during power failure, a battery backed 5V DC supply is needed to be connected to the MX93021 and ARAM.

The signal of power failure indication is connected to the MX93021 through PWD\ pin (pin 15). A reset signal (RST\) is also connected to the MX93021 (pin 96).

When power failure happens, the PWD\ should go low at least 5 ms and RST\ should be high at least 60 ms for the MX93021 to terminate any operating mode and enter power-down mode.

While in power-down mode, the MX93021 will not respond to any command from the HOST, refreshing ARAM is continued and system runs with low crystal 32768 Hz to save backup power.

8.0 COMMAND FORMAT AND PROTOCOL
8.1 RECORD MODE

	15	14	13	12	11	10	09	08	07	06	05	04	03	02	01	00
CONF	0001				MARK Fail	Marked Record			Pause	Stop	Tail Cut					

Tail Cut -- cut tail in 400 ms unit

Stop -- "1" for STOP,"0" for START

Pause -- "1" to pause recording,"0" to continue recording

Marked Record -- recording to special message record 63~57

000 -- not a marked record

001 -- message record 63

010 -- message record 62

011 -- message record 61

100 -- message record 60

101 -- message record 59

110 -- message record 58

111 -- message record 57

Marked Records do not wrap around with normal recording message; they are reserved for announcement.

MARK Fail -- When Mark Record fails, user can set this bit to recover original recorded Message.

	15	14	13	12	11	10	09	08	07	06	05	04	03	02	01	00
RESP	Record Time (sec)								Mfull	VOX	Tone	Cont Tone	DTMF			

DTMF -- the index of the DTMF which is detected in the process of recording

Tone -- "1" to indicate the presence of call progress tone

VOX -- "1" the speech power level is under VOX threshold

Mfull -- "1" ARAM full, no further recording is possible

Record time -- report how many seconds are recorded in this message. (0 - EF)

Cont Tone -- "1" the continuous tone is detected

DTMF Reference

Table →

index	DTMF CODE
0	NO TONE
1	1
2	2
3	3
4	4
5	5
6	6
7	7
8	8
9	9
A	*
B	0
C	#

8.2 PLAY MODE

	15	14	13	12	11	10	09	08	07	06	05	04	03	02	01	00
CONF	0010				fast play	Play New	Stop	Pause	Real Del	Del Mark	Msg ID					

Msg ID -- 1~63 message ID may be assigned for playing.
 Del Mark -- a delete mark will show a message record which is to be deleted, the actual deletion is referred to "Real Del" condition when it occurs.
 Real Del -- actually and immediately delete the messages that have been tagged a del mark; in the same time, tag old mark to the message that have been played.
 Pause -- "1" pause the playing
 "0" continue
 Stop -- "0" play
 "1" stop the playing and return to idle
 Play New -- search to play the non-played message
 fast play -- "1" play speed will be up to 33%
 "0" normal speed

	15	14	13	12	11	10	09	08	07	06	05	04	03	02	01	00
RESP	Play Time (sec)								Play End	Tone	Cont Tone	DTMF				

DTMF -- detect DTMF during the last call service.
 Cont Tone, Tone -- see 8.2 Record Mode
 Play End -- end of playing of the message
 Play Time -- playing time till now

8.3 MESSAGE STATUS MODE

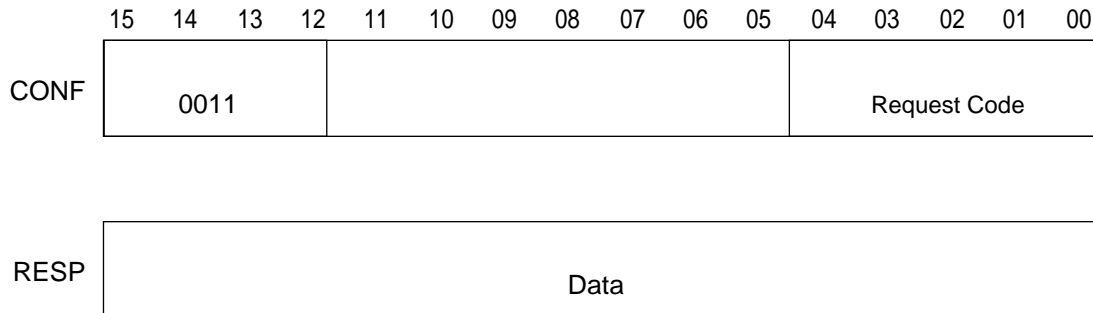

REQUEST CODE:

REQUEST CODE	STATUS	DATA
0000	number of recorded message	00 ~ 63
0001	number of new message	00 ~ 63
0010	number of old message	00 ~ 63
0011	available time(sec)	00 ~ 65535

8.4 TONE GENERATOR MODE

	15	14	13	12	11	10	09	08	07	06	05	04	03	02	01	00
CONF	0100				start/ stop	0	0	0	Gain2				Gain1			

Gain1, Gain2 -- 0 dbm ~ -28 dbm, 2 db step down from 0.

Start/Stop -- "1" stop generating DTMF

"0" start to generate DTMF

DTMF START

	15	14	13	12	11	10	09	08	07	06	05	04	03	02	01	00
CONF	0100				1	0	0	0	Gain2				Gain1			

RESP	0100				1	0	0	0	Gain2				Gain1			
------	------	--	--	--	---	---	---	---	-------	--	--	--	-------	--	--	--

CONF	F1															
------	----	--	--	--	--	--	--	--	--	--	--	--	--	--	--	--

RESP	F1															
------	----	--	--	--	--	--	--	--	--	--	--	--	--	--	--	--

CONF	F2															
------	----	--	--	--	--	--	--	--	--	--	--	--	--	--	--	--

RESP	F2															
------	----	--	--	--	--	--	--	--	--	--	--	--	--	--	--	--

Note that F1,F2=Target frequency *8.19

DTMF STOP

	15	14	13	12	11	10	09	08	07	06	05	04	03	02	01	00
CONF	0100				0	0	0	0	0	0	0	0	0	0	0	0

RESP	0100				0	0	0	0	0	0	0	0	0	0	0	0
------	------	--	--	--	---	---	---	---	---	---	---	---	---	---	---	---

8.5 LINE MONITOR MODE

	15	14	13	12	11	10	09	08	07	06	05	04	03	02	01	00
CONF	0101				0	0	0	0	0	0	0	0	0	0	0	STOP

RESP									VOX	Tone	Cont Tone	DTMF				
------	--	--	--	--	--	--	--	--	-----	------	--------------	------	--	--	--	--

DTMF, Vox, Tone, cont Tone -- see RECORD MODE

STOP -- "0" start to monitor line

"1" stop monitoring line and return to idle

8.6 DELETE MESSAGE MODE

	15	14	13	12	11	10	09	08	07	06	05	04	03	02	01	00
CONF	0110				Del Mark CLR	Del New MSG	0	0	Del All Old	0	Msg ID					

Msg ID -- message to be deleted (if DEL All Old "1", this field is "don't care")

Del All Old -- delete all old messages which have been played; Msg ID is "don't care".

Del New MSG -- delete new message

Del Mark CLR -- when deleting messages, use "delete mark" to recover messages

	15	14	13	12	11	10	09	08	07	06	05	04	03	02	01	00
RESP	0110															E

E -- "0" indicate valid message

"1" indicate invalid message

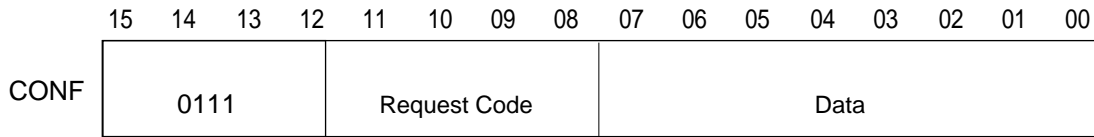
8.7 SET CURRENT TIME & OPT

REQUEST CODE:

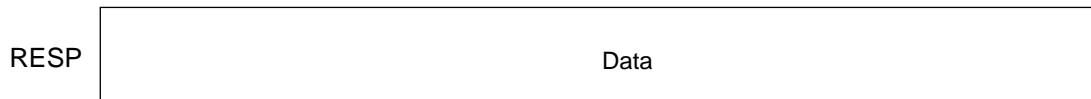
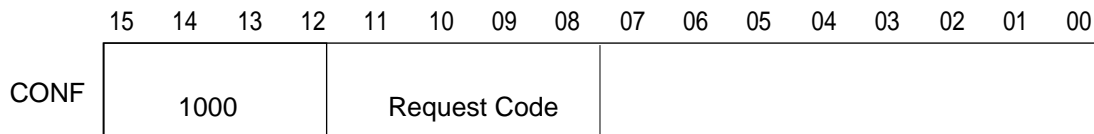
TIME	REQUEST CODE	DATA
SECOND	0000	0000 ~ 003B
MINUTE	0001	0000 ~ 003B
HOUR	0010	0000 ~ 0017
WEEK	0011	0000 ~ 0006
OPT 7-0	0100	
OPT 13-8	0101	

8.8 GET CURRENT TIME & OPT & IPT

Request Code: (see Set Current Time)

REQUEST CODE:

TIME	REQUEST CODE	DATA
SECOND	0000	0000 ~ 003B
MINUTE	0001	0000 ~ 003B
HOUR	0010	0000 ~ 0017
WEEK	0011	0000 ~ 0006
OPT 7-0	0100	
OPT 15-8	0101	
IPT	0110	

8.9 INITIAL AND TEST MEMORY MODE

	15	14	13	12	11	10	09	08	07	06	05	04	03	02	01	00
CONF	1001				VOP Adr	ROM SPEED	VOP ROM/ RAM	WORD BYTE	0	0	ANNC DEL	VOX on/off	Line ON/OFF	Fast Aram Test	ARAM CHECK	Init Aram

Init Aram -- re-initialize Aram, whole ARAM will be checked and constructed for message storage.

ARAM CHECK --Check ARAM DATA is Good/Bad

Fast Aram Test: 1 -- Fast Aram Test (6 sec.)

0 -- Complete Aram Test (36 sec.)

Line ON/OFF -- for line input signal to Echo Cancellation

1 -- ON

0 -- OFF

Vox ON/OFF --for Record mode to select VOX ON/OFF Record.

1 -- ON

0 -- OFF

ANNC DEL: 1 -- delete old ANNC before New ANNC.

0 -- delete old ANNC after New ANNC.

Word BYTE: 1 -- VOP Access by WORD

0 -- VOP Access by BYTE

VOP ROM/RAM : 1 -- VOP at RAM

0 -- VOP at ROM

VOP ADR : 1 -- 4800 Hex

0 -- 8000 Hex

Note: if VOP at RAM, the VOP Address is at 800H.

if VOP at ROM, the VOP Address is set by VOP ADR.

	15	14	13	12	11	10	09	08	07	06	05	04	03	02	01	00
RESP								Aram Good	Aram Addr Size				Aram Bit Size			

Aram Bit Size -- data bit number in one ARAM address access.

Aram Addr Size -- detected ARAM existed address space.

Aram Good -- a conclusion of ARAM check, if good, system may start to run.

CODE	ARAM ADDR. SIZE	CODE	ARAM BIT SIZE
0000	00 M	0000	00
0001	64 K	0001	1
0010	128 K	0010	2
0011	256 K	0011	3
0100	512 K	0100	4
0101	1 M	1000	8
0110	2 M	1100	12
0111	4 M	1111	16
1000	8 M		
1001	16 M		

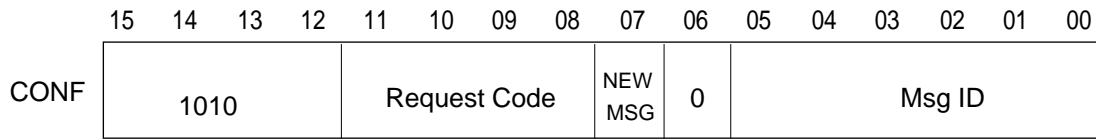
8.10 GET RECORD MESSAGE TIME MODE

NEW MSG -- Get New Message Time.

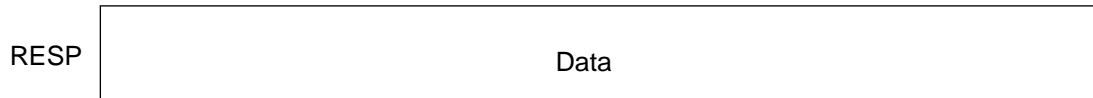
ICM

TIME	REQUEST CODE	DATA
SECOND	0000	0000 ~ 003B
MINUTE	0001	0000 ~ 003B
HOUR	0010	0000 ~ 0017
WEEK	0011	0000 ~ 0006
RECORD TIME	0100	BITS 15 ~ BITS 0 (0000 - 00EF)
TIMER STATUS	0101	1=Timer has setted 0=default Timer
ICM/MEMO	0110	1=MEMO record 0=ICM record
DEL MARK STATUS	0111	1=Had del Mark 0=Had not del Mark

OGM

	REQUEST CODE	DATA
exist	xxxx	1:Yes 0:No

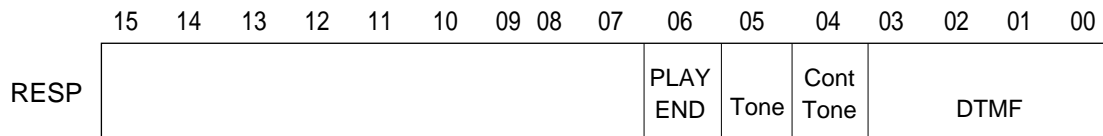
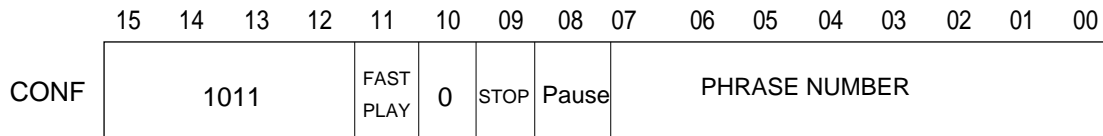
8.11 VOICE PROMPT MODE

PHRASE NUMBER : MXIC support base voice prompt from 1 to 255 .

Others : Refer to " Play Mode "

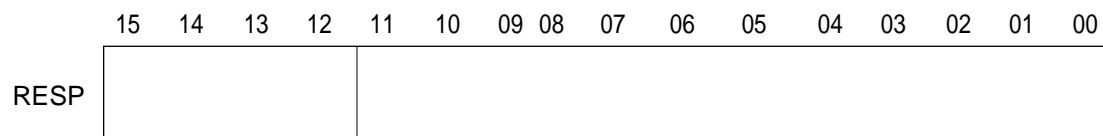
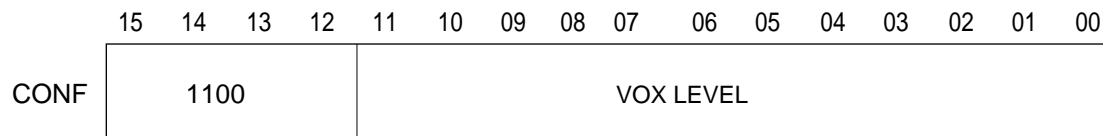
8.12 VOICE ACTIVITY MODE

Adjust VOX Level see TABLE VII

8.13 PERSONAL MAIL MODE

	15	14	13	12	11	10	09	08	07	06	05	04	03	02	01	00
CONF	1101				0	0	0	0	0	0	0	0	MEMO /ICM	PERSONAL MAIL		

	15	14	13	12	11	10	09	08	07	06	05	04	03	02	01	00
RESP																

PERSONAL MAIL : For incoming messages, separate to max 8 persons when setting this mode; others mode (play mode, record mode) will automatically change to this personal mail.

memo -- "0" ICM

"1" MEMO

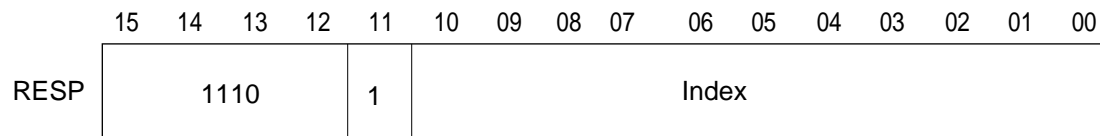
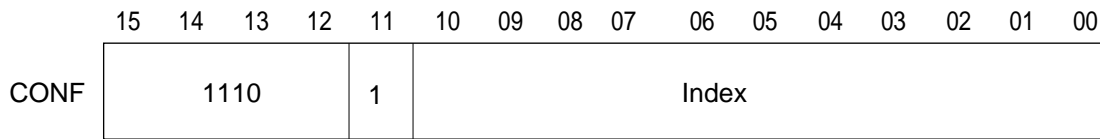
8.14 TELEPHONE NUMBER MODE
WRITE TELEPHONE NUMBER

DATA : If memory is OK, respond DATA
 -DATA : If memory is failed, respond the inverse of DATA

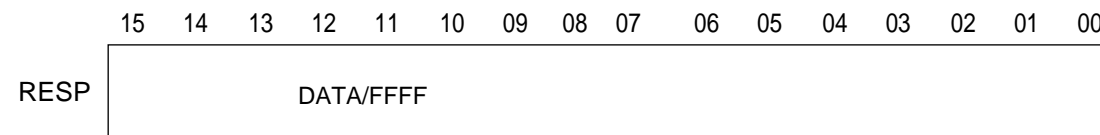
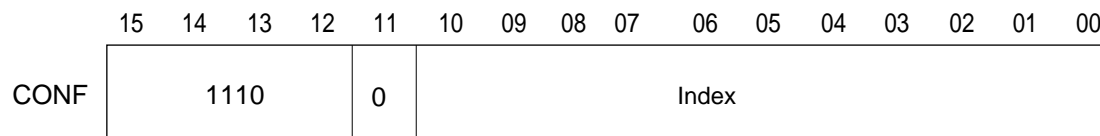
READ TELEPHONE NUMBER

DATA -- if memory is OK, respond DATA
 FFFF -- if memory is failed, respond FFFF

TABLE I
COMMAND AND STATUS TABLE

CMD State	REC	RECORD (Mark Fail/Stop/*NON_INIT)	PLAY	PLAY (STOP/R.D./D.M.)	MES	TONE	LINE (STOP)	DELET
REC	REC RESP	IDLE(Mark Fail/Stop) xxxx	REC ----	REC ----	REC ---	REC tone	REC ---	REC ---
PLAY	PLAY ----	PLAY ----	PLAY RESP	IDLE xxxx	PLAY ----	PLAY tone	PLAY ---	PLAY ---
LINE	LINE ----	LINE ----	LINE ----	LINE ----	LINE ---	LINE ----	LINE/IDLE RESP	LINE ---
VOICE	VOICE ----	VOICE ----	VOICE ---	VOICE ---	Voice ---	Voice ----	Voice ---	Voice ---

COMMAND AND STATUS TABLE

CMD State	S.T/O	G.T//O	INIT.	GET REC. TIME	VOICE	VOICE (STOP)	VOX	MAIL	TEL.
REC	REC 7xxx	REC xxxx	REC ----	REC ----	REC ----	REC ----	REC ----	REC ----	REC ----
PLAY	PLAY 7xxx	PLAY xxxx	PLAY ----	PLAY ----	PLAY ----	PLAY ----	PLAY ----	PLAY ----	PLAY ----
LINE	LINE 7xxx	LINE xxxx	LINE ----	LINE ----	LINE ----	LINE ----	LINE ----	LINE ----	LINE ----
VOICE	VOICE 7xxx	VOICE xxxx	VOICE ----	VOICE ----	VOICE RESP	IDLE RESP	VOICE ----	VOICE ----	VOICE ----

Note:

- 1.The above table shows the transition between current state and next state after receiving a command. It also shows the correct response word.
- 2."----" means no response word.

TABLE II : PERFORMANCE TEST FOR TONE DETECTION

(noiseless) Power(db)	0	-3	-6	-10	-20	-30	-33	-36	-39
p2p(volt)	5	3.54	2.5	1.58	.5	.158	.112	.079	.056
350Hz	x	x	x	ok	ok	ok	ok	x	x
400Hz	x	x	ok	ok	ok	ok	ok	ok	x
450Hz	x	ok	ok	ok	ok	ok	x	x	x
500Hz	ok	ok	ok	ok	ok	ok	ok	x	x
550Hz	ok	ok	ok	ok	ok	ok	ok	x	x
600Hz	ok	ok	ok	ok	ok	ok	ok	ok	x
650Hz	ok	ok	ok	ok	ok	ok	ok	x	x
480+620 Hz	ok	ok	ok	ok	ok	ok	x	x	x

* 0 dB is defined as the Vrms of maximum codec input

** The maximum peak_to_peak voltage (P2P) of codec input is assumed to be 5V

SNR(dB)	40	25	12
Freq	detection time delay / off time delay (ms)		
300Hz	50 / 40	55 / 40	65 / 40
400Hz	40 / 40	40 / 40	45 / 45
500Hz	40 / 40	40 / 40	45 / 45
640Hz	45 / 40	45 / 40	60 / 35
480+620	40 / 40	45 / 40	50 / 40
350+440	45 / 40	45 / 40	55 / 40

* 0 dB is defined as the Vrms of maximum codec input

** the detect/off time delay is defined as follows

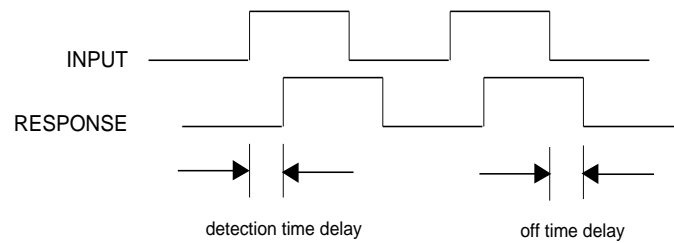

TABLE III : RESOLUTION TEST FOR DUAL TONE (FREQUENCY DETECTABLE RANGE)

RANGE / POWER	-4 dB	-25 dB
(330 and F2 Hz)	F2 > 540 Hz	F2 > 540 Hz
(650 and F2 Hz)	F2 < 640 Hz	550 Hz < F2 < 620 Hz 340 Hz < F2 < 420 Hz

TABLE IV : THD DISTORTION TEST FOR DUAL TONE (DISTORTION TOLERANCE)

INPUT / POWER	-4 dB	-25 dB
(540 and 330 Hz)	> 8 dB	> 8 dB
(650 and 520 Hz)	> 8 dB	> 8 dB

* 0 dB is defined as the Vrms of maximum codec input

TABLE V : CALL PROGRESS TONE DETECTOR CHARACTERISTICS

PARAMETER	MIN	TYP	MAX	UNIT
Detection level *	-30			dB
Rejection level			-35	dB
Frequency range	330		660	Hz
Noise tolerance			-10	dB
Rejection Frequency range	< 270 Hz	or	> 740 Hz	

* 0 dB is defined as the Vrms of maximum codec input

TABLE VI : DTMF CHARACTERISTICS

PARAMETER	MIN	TYP	MAX	UNIT
DTMF Signal level for detection*	-43		0	dB
DTMF Twist (High/Low Tone)		+/-9		dB
DTMF Noise Tolerance		-10		dB
DTMF Tone duration accept	40			ms
DTMF interdigit pause accept	40			ms
DTMF Frequency deviation accept limit		+/-1.5		%
DTMF Frequency deviation reject limit		+/-3		%
Tone Generator level	- 25		+ 3	dB
Tone Generator frequency accuracy		± 0.1		%
Tone Generator level accuracy		± 0.5		dB

* 0 dB is defined as the vrms of maximum codec input

TABLE VII. VOX THRESHOLD *

dB	VOX_LVL
-9	0ef5
-10	0d55
-11	0be5
-12	0a95
-13	0975
-14	0875
-15	0ef4
-16	0d54
-17	0be4
-18	0a94
-19	0974
-20	0874
-21	0ef3
-22	0d53
-23	0be3
-24	0a93
-25	0973
-26	0873
-27	0783
-28	06b3
-29	05f3
-30	0553
-31	04c3
-32	0433
-33	03c3
-34	0363
-35	0303
-36	02b3
-37	0263
-38	0223
-39	01e3
-40	01b3
-41	04c2
-42	0442
-43	03c2
-44	0362
-45	0302
-46	02b2
-47	0262
-48	0222
-49	01e2
-50	01b2
-51	0301
-52	02b1
-53	0261
-54	0221
-55	01e1
-56	01b1
-57	0300
-58	02b0
-59	0260
-60	0220
-61	01e0
-62	01b0

* 0 dB is defined as the Vrms of maximum codec input.

TABLE VIII. Echo CANCELLER PERFORMANCE *

Test Description	
Final Echo Return Loss Improvement (ERLI) (Singletalk mode)	> 28 dB
Maximum tail length	12 ms
CONVERGENCE RATE (SINGLETALK MODE) 500ms after initialization with cleared register and with near_end signal set to zero at initialization time	> 28 dB
Infinite Return Loss Convergence Return Echo Loss Improvement 500ms after echo path is interrupted	> 28 dB

* test signals : band-limited white-noise(300-3400Hz)

TABLE IX : MAXIMUM COMMAND RESPONSE TIME TEST

COMMAND	MAX RESP TIME (ms)
Record	7
Playback	30/5
Get message number (3000/3001)	8
Get free time (3003)	52
Tone generation	1
Line monitor	7
Delete one message (60xx/64xx)	22
Delete all old messages (6080)	748
Set time (7xxx)	1
Get time (8xxx)	1
Initialize aram (for 1M x 4)	6000 or 35000
Get record message time	12
Voice prompt generation	5
Set voice activity (Cxxx)	1
Set personal mail (Dxxx)	1
Tel. number mode (Exxxx)	10

DC CHARACTERISTICS: TA = 0 to 70°C, VCC = 5V ± 10%

SYMBOL	PARAMETER	MIN	TYPE	MAX	UNIT
VCC	Supply voltage	4.5	5	5.5	V
GND	Supply voltage		0		V
VOH	Output high voltage		4		V
VOL	Output low voltage		0.3	0.6	V
VIH	Input high voltage	BIO(7:0), ED(15:0), HOLD\, EROM(schmite-trigger)	3.5		V
		all others		2.0	V
VIL	Input low voltage	BIO(7:0), ED(15:0), HOLD\, EROM(schmite-trigger)	-0.1	1.5	V
		all others		0.8	V
IOLA	Output low current type A	4	OA		mA
IOLB	Output low current type B	4	OB		mA
IOLC	Output low current type C	16	OC		mA
IOHA	Supply high current (HOLD\)	2			mA
IOHB	Supply high current(HOLD\)	2			mA
IOHC	Supply high current(HOLD\)	8			mA
ICC	Supply current(HOLD\)		10		mA

AC CHARACTERISTICS:
ROM READ TIMING

SYMBOL	PARAMETER	MIN	NOM	MAX	UNIT
Tcs	Chip select access time	25+wTc			ns
Taa	Address access time	25+wTc			ns
Ts(rd-d)	Data set-up time before ERD\ high	12			ns
Th(rd-d)	Data hold time after ERD\ high	0			ns
Th(ce-a)	Address hold time after ERD\ high	0			ns
Ts(a-r)	Address set-up time before ERD\		10		ns

AC CHARACTERISTICS: (Continued)
CLOCK TIMING

SYMBOL	PARAMETER	MIN	NOM	MAX	UNIT
Tc(c)	CLKIN cycle time	30	36	42	ns
Tl _{pd} (c)	CLKIN low pulse duration(tc=30ns)	12	15	18	ns
Th _{pd} (c)	CLKIN high pulse duration (tc=30ns)	12	15	18	ns
Td(c-m)	CLKIN to MCO delay time	0		15	ns

CODEC TRANSMIT AND RECEIVE TIMING

SYMBOL	PARAMETER	MIN	NOM	MAX	UNIT
Tc (mck)	MCK cycle time		650		ns
Tl _{pd} (mck)	MCK low pulse duration	315		335	ns
Th _{pd} (mck)	MCK high pulse duration	315		335	ns
Td (ch-fs)	MCK to FS delay time			20	ns
Td (ch-dx)	DX valid after MCK rising edge			10	ns
Ts (dr)	DR set-up time before MCK falling edge	10			ns
Th (dr)	DR hold time before MCK falling edge	10			ns

RESET TIMING

SYMBOL	PARAMETER	MIN	NOM	MAX	UNIT
Tw (rst)	Reset low pulse width	3Tc			ns

DRAM TIMING

SYMBOL	PARAMETER	MIN	NOM	MAX	UNIT
Tras	RAS\ low pulse duration	10Q-10	10Q		ns
Trp	RAS\ precharge time	7Q-10	7Q		ns
Trcd	RAS\ to CAS\ delay time	4Q-10	4Q		ns
Tcas	CAS\ low pulse duration	6Q-10	6Q		ns
Tcp	CAS\ precharge time	2Q-5	2Q		ns
Tasr	Row address set-up time	1Q-10	1Q		ns
Trah	Row address hold time	3Q-10	3Q		ns
Tasc	Column address hold time	6Q-10	1Q		ns
Tach	Column address hold time	6Q-10	6Q		ns
Td(rd-c)	DRD\ low to CAS\ low	1Q-10	1Q		ns
Td(wr-c)	DWR\ low to CAS\ low	1Q-10	1Q		ns
Ts(cas)	Data set-up time before CAS\ high	1Q			ns
Th(cas)	Data hold time after CAS\ high	5			ns
Ts(w-ca)	Data set-up time before CAS\ low	1Q-10			ns
Th(w-ca)	Data hold time before CAS\ low	4Q-10	4Q		ns

uP INTERFACE

SYMBOL	PARAMETER	MIN	NOM	MAX	UNIT
tsR	Host read access time		50		ns
thR	Read data hold time	5			ns
tsW	Write data set up time	20			ns
thW	Write data hold time	10			ns

Note:*w=number of wait state

*Q=1/2 TC

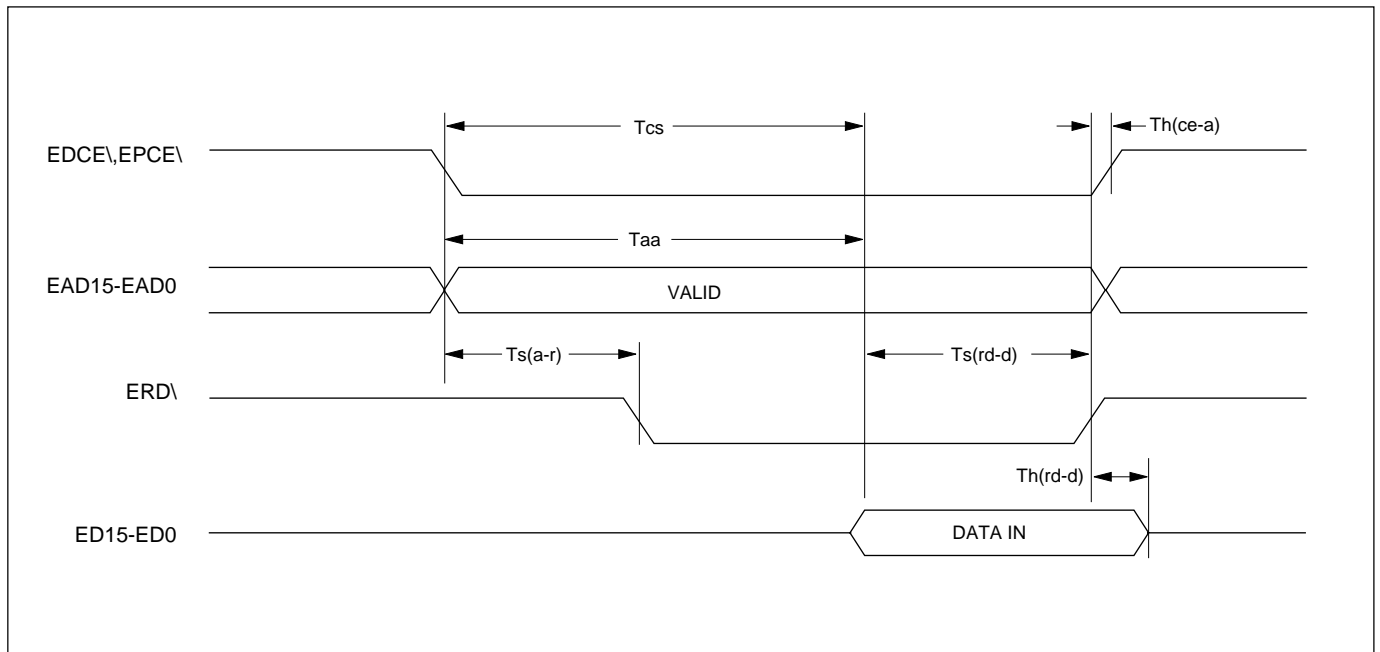
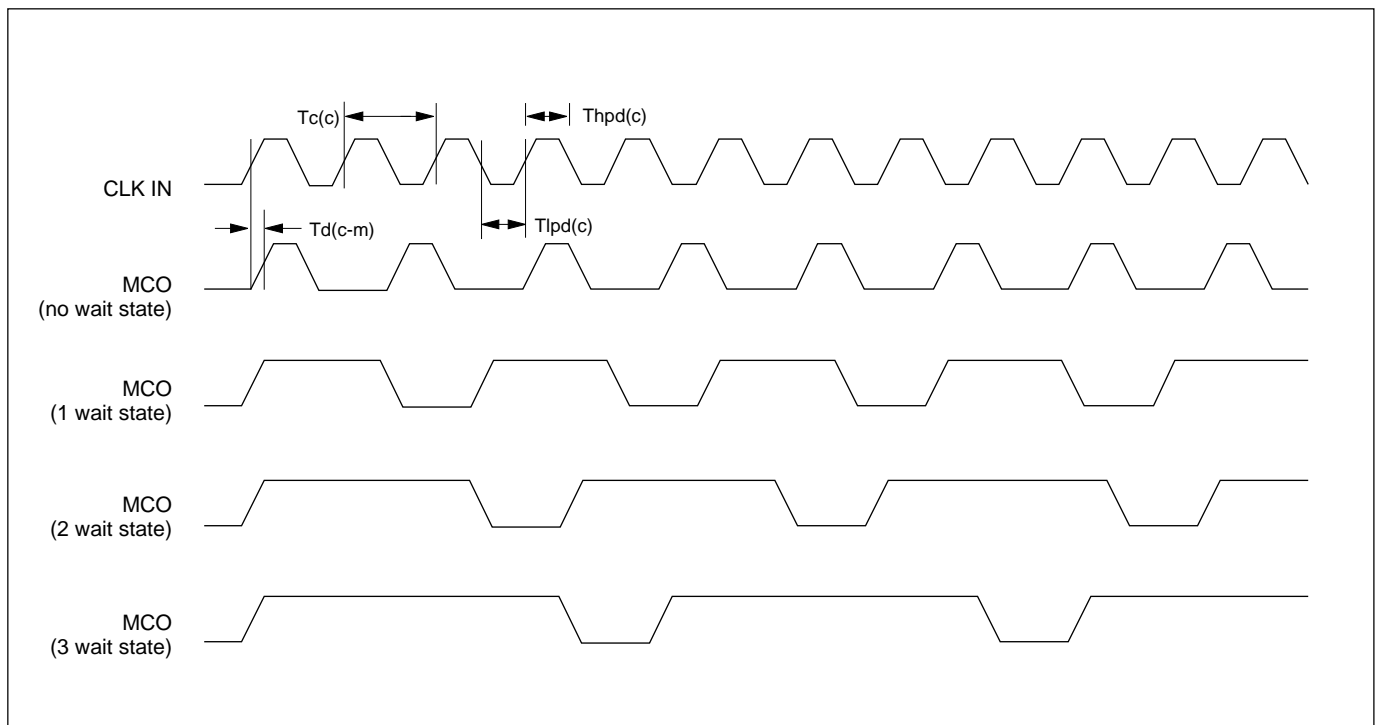
ROM READ TIMING

TIMING WAVEFORMS
CLOCK TIMING

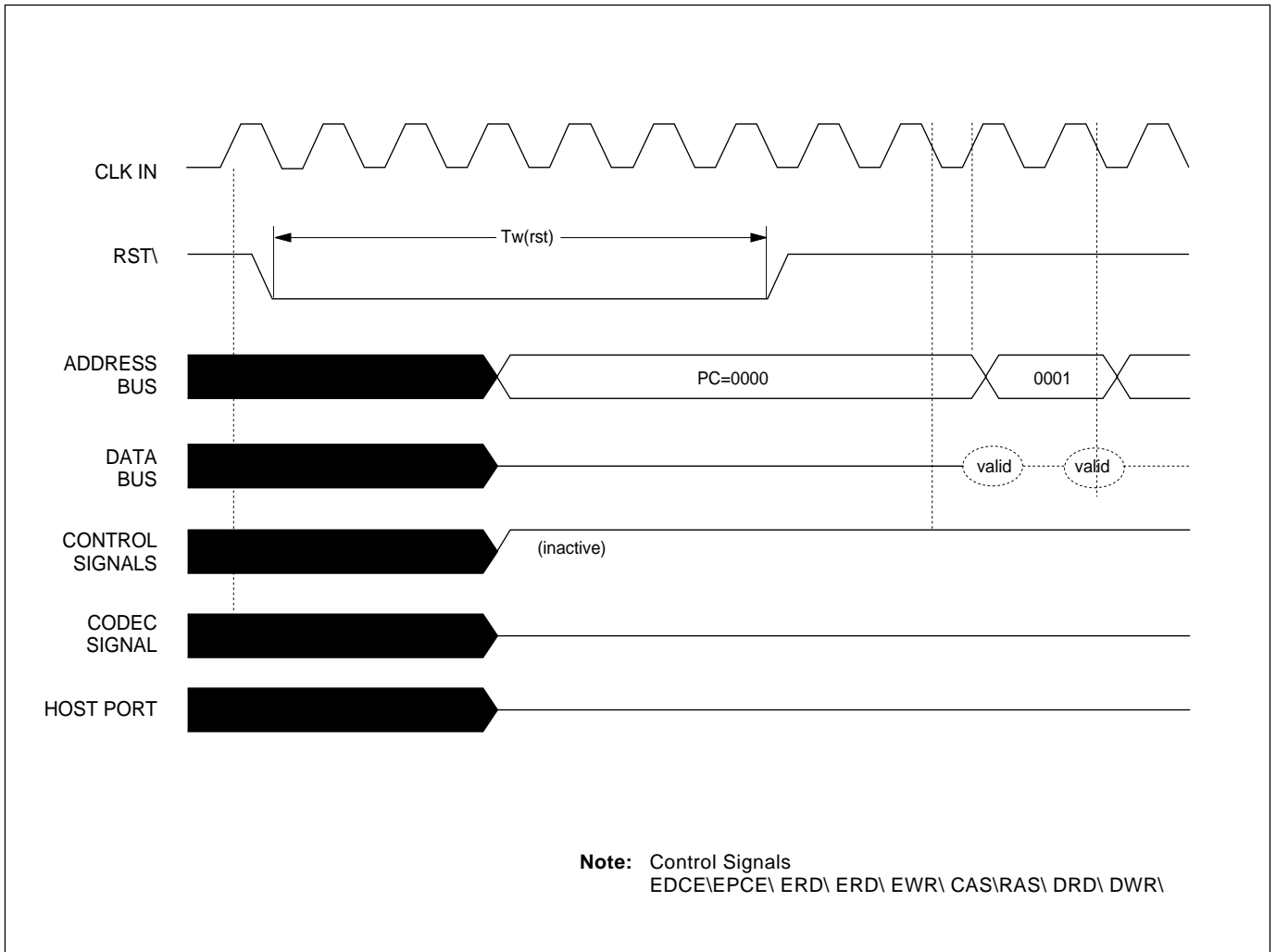
RESET TIMING

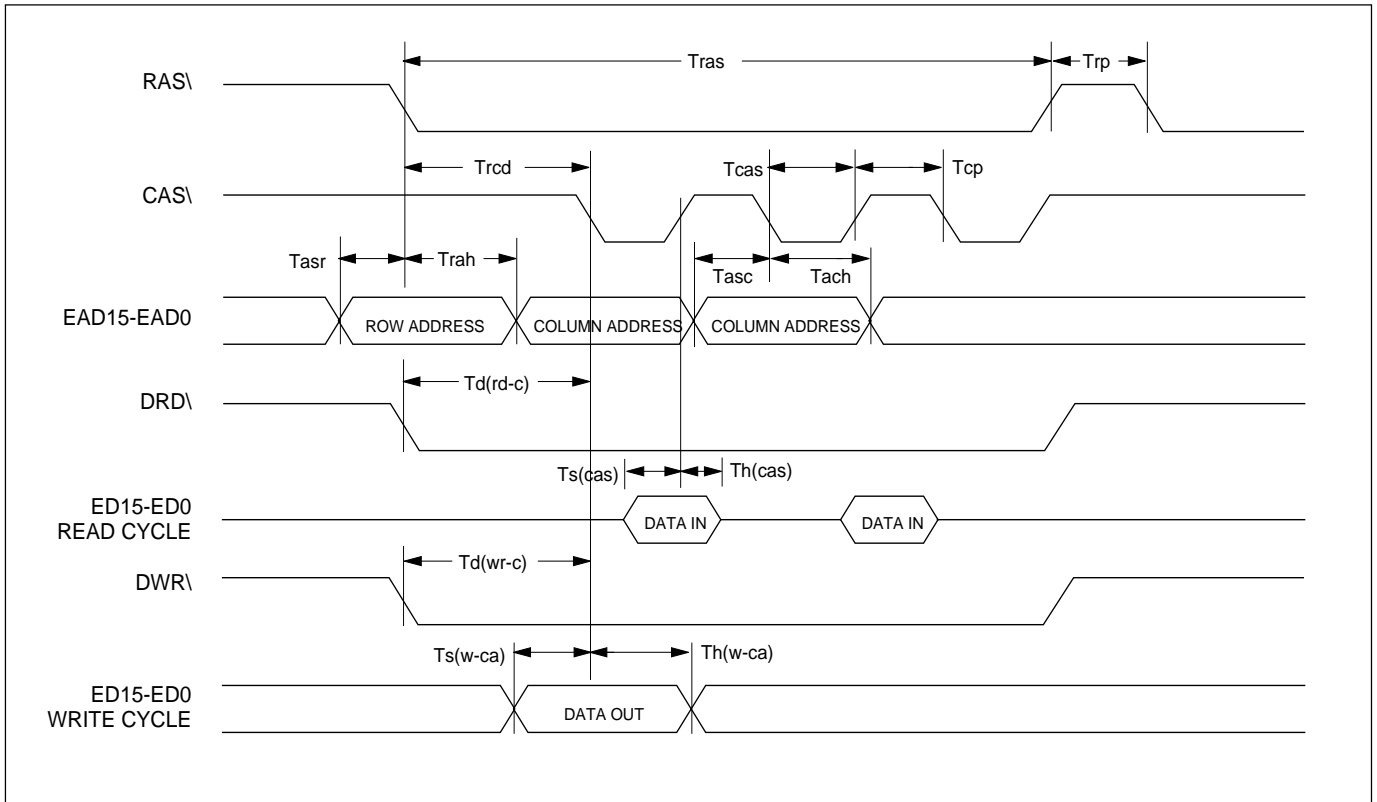
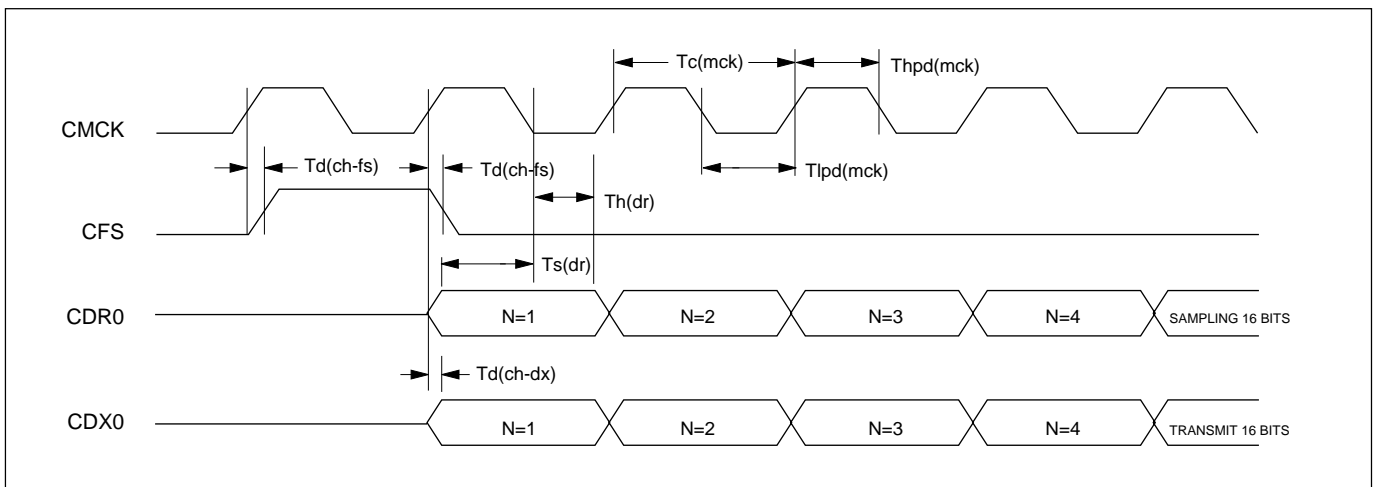

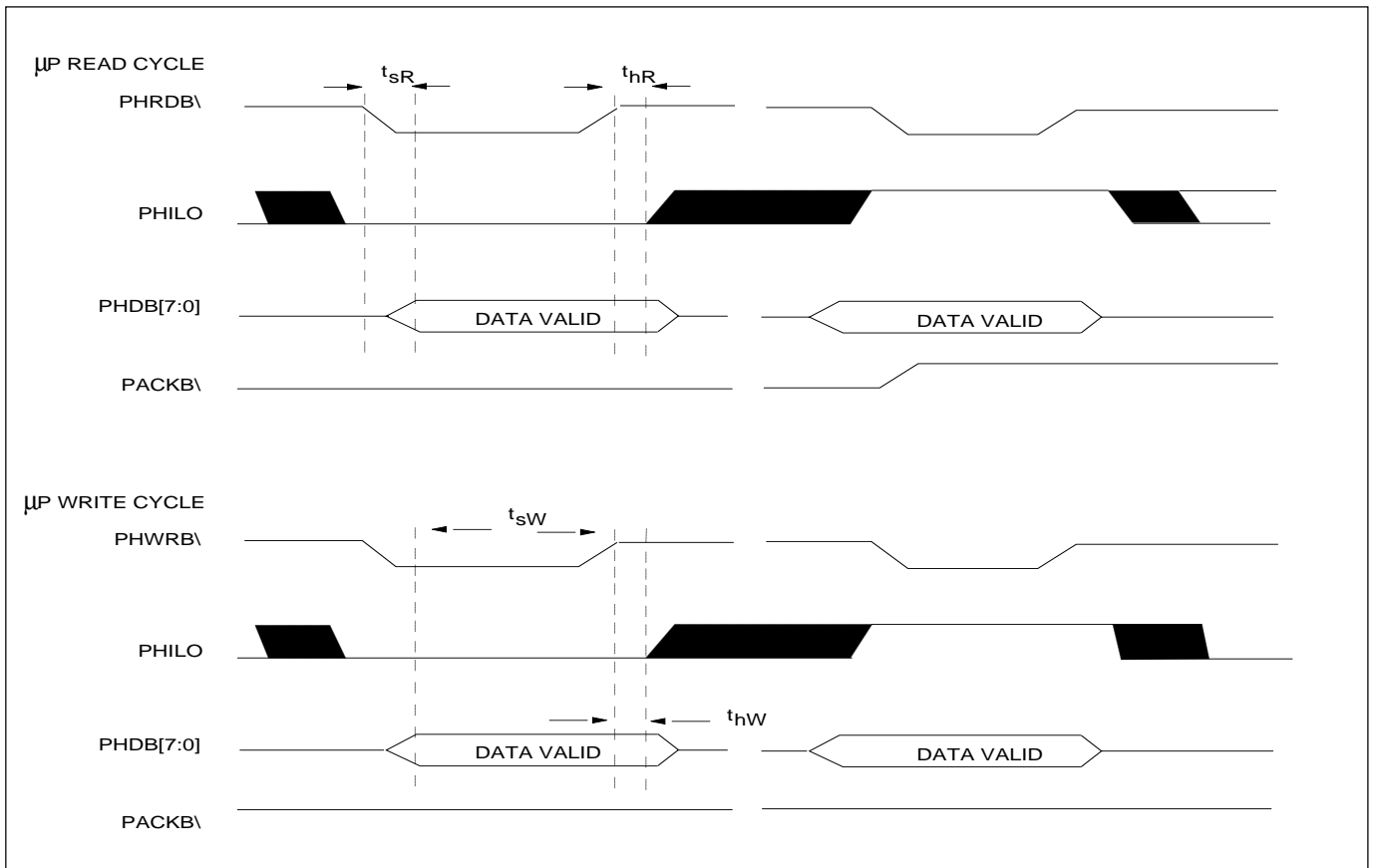
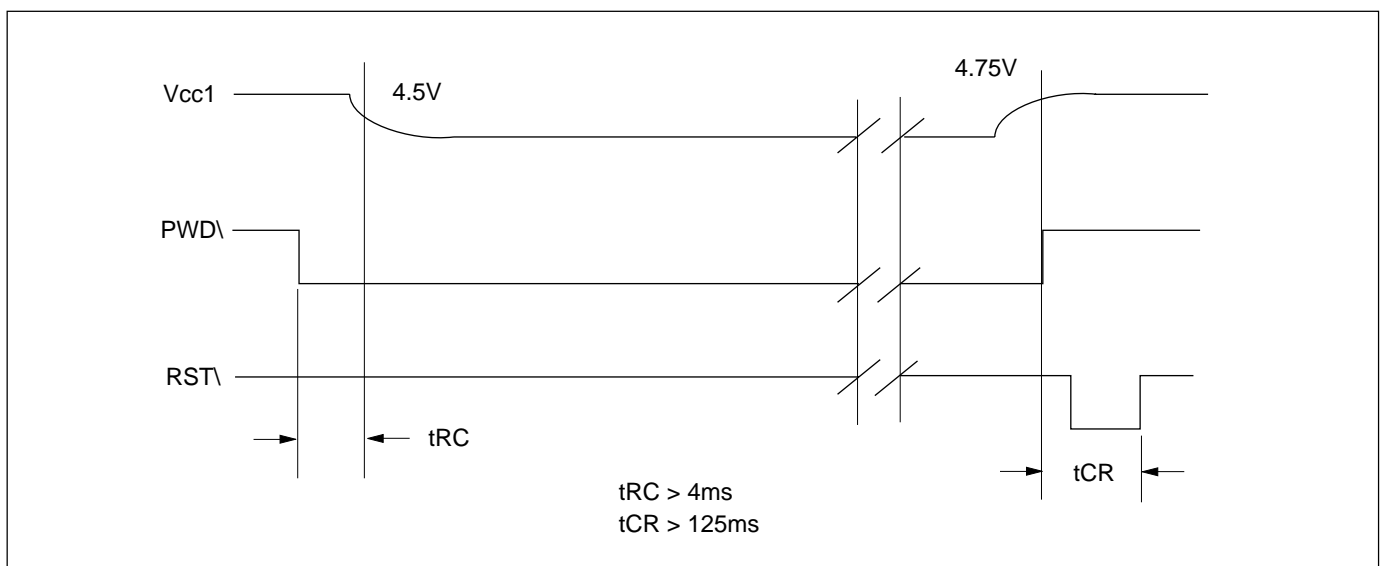
DRAM READ/WRITE TIMING

CODEC PORT TRANSMIT AND RECEIVE TIMING

μP INTERFACE TIMING

POWER UP/DOWN TIMING

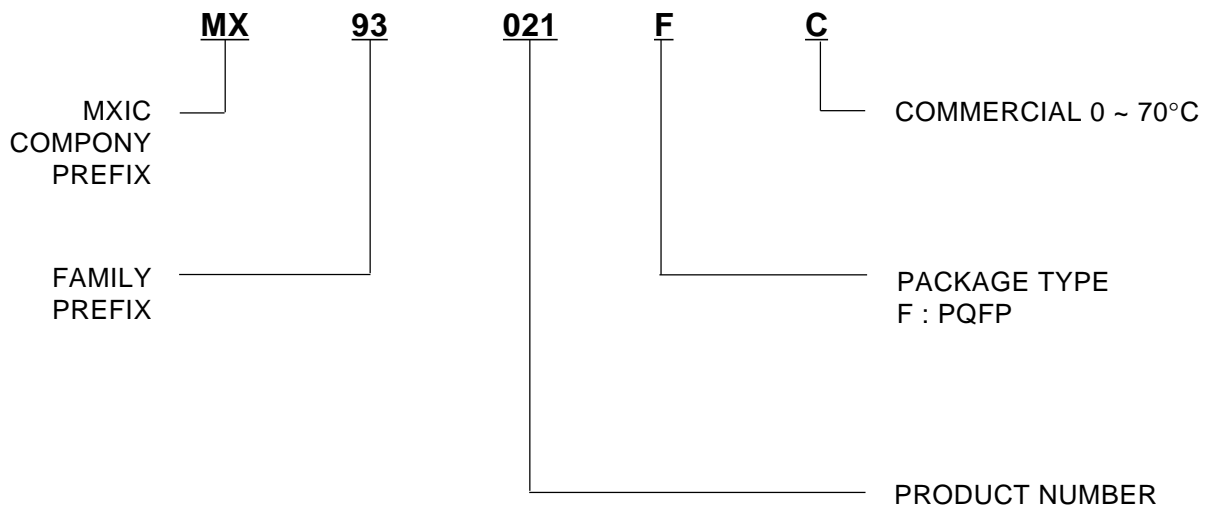
ORDERING INFORMATION

PART NO.	PACKAGE
MX93021FC	PQFP



PACKAGE INFORMATION
100-PIN PQFP

ITEM	MILLIMETERS	INCHES
A	24.80 ± .40	.967 ± .016
B	20.00 ± .13	.787 ± .005
C	14.00 ± .13	.551 ± .005
D	18.80 ± .40	.740 ± .016
E	12.35 [REF]	.486 [REF]
F	.83 [REF]	.033 [REF]
G	.58 [REF]	.023 [REF]
H	.30 [Typ.]	.012 [Typ.]
I	.65 [Typ.]	.026 [Typ.]
J	2.40 [Typ.]	.094 [Typ.]
K	1.20 [Typ.]	.047 [Typ.]
L	.15 [Typ.]	.006 [Typ.]
M	.10 max.	.004 max.
N	2.75 ± .15	.108 ± .006
O	.10 min.	.004 min.
P	3.30 max.	.103 max.

NOTE: Each lead centerline is located within .25mm(.01 inch) of its true position [TP] at a maximum material condition.

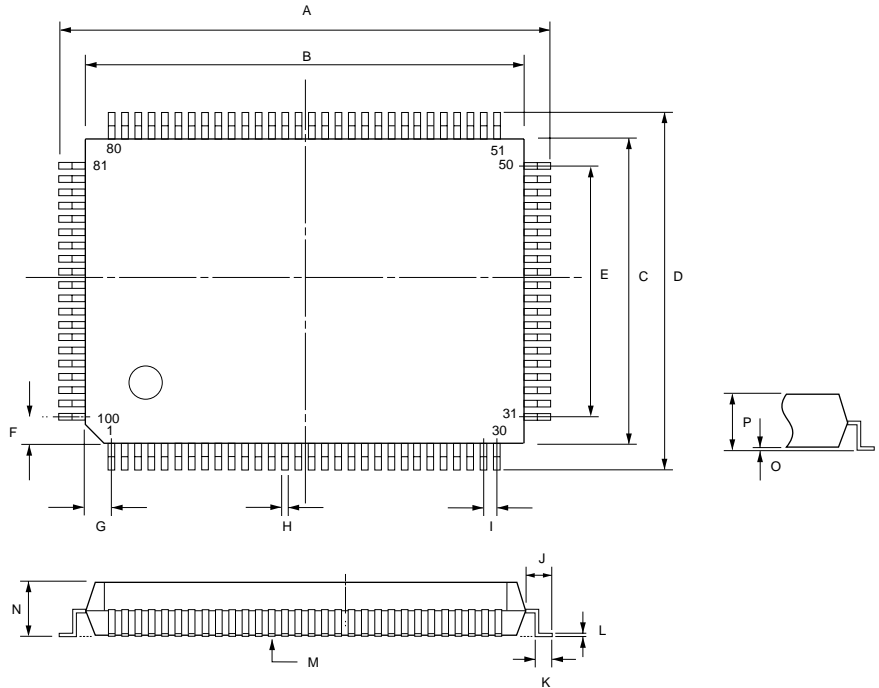

MACRONIX INTERNATIONAL Co., LTD.**HEADQUARTERS:**

No. 3, Creation Road III, Science-Based Industrial Park, Hsin Chu, Taiwan, R.O.C.

TEL : +886-3-578-8888

FAX: +886-3-578-8887

TAIPEI OFFICE:

12F, No. 4, Min-Chuan E. Rd., Sec. 3, Taipei, Taiwan, R.O.C.

TEL : +886-2-509-3300

FAX: +886-2-509-2200

EUROPE OFFICE:

Grote Winkellaan 95, Bus 1 1853 Strombeek, Belgium

TEL : +32-2-267-7050

FAX: +32-2-267-9700

SINGAPORE OFFICE:

5 Jalan Masjid Kembangan Court #01-12 Singapore 418924

TEL : +65-747-2309

FAX: +65-748-4090

MACRONIX AMERICA, INC.

1338 Ridder Park Drive, San Jose, CA95131 U.S.A.

TEL : +1-408-453-8088

FAX: +1-408-453-8488

JAPAN OFFICE:

NFK Kawasaki Building, 8F 1-2 Higashida-cho, Kawasaki-ku

Kawasaki-shi, Kawasaki-ken 210, Japan

TEL : +81-44-246-9100

FAX: +81-44-246-9105