

- ◆ 2ch DC/DC Controller (Step-Down + Inverting)
- ◆ Input Voltage Range 2.0V ~ 10.0V
- ◆ Output Voltage Externally Set-Up
- ◆ Oscillation Frequency 180kHz (±15%)
- ◆ Max Duty Ratio Step-Down : 100%
Inverting : 80% (Typ.)
- ◆ PWM, PWM/PFM Switching Control
- ◆ MSOP-10 Package

General Description

The XC9505 series are PWM control, PWM/PFM switching, 2 channel (step-down and inverting) DC/DC controller ICs. With 0.9V of standard voltage supply internal, and using externally connected components, the output 1 voltage (step-down DC/DC controller) can be set freely within a range of 0.9V ~ 6.0V. Since output 2 (inverting DC/DC controller) has a built-in 0.9V reference voltage (accuracy ±2), a negative voltage can be set with the external components. With a 180kHz frequency, the size of the external components can be reduced. Switching frequencies of 300kHz and 500kHz are also available as custom-designed products. The control of the XC9505 series can be switched between PWM control and PWM/PFM automatic switching control using external signals. Control switches from PWM to PFM during light loads when automatic switching is selected and the series is highly efficient from light loads through to large output currents. Noise is easily reduced with PWM control since the frequency is fixed.

The series gives freedom of control selection so that control suited to the application can be selected. Soft-start time is internally set to 10msec (output 1)

which offers protection against rush currents and voltage overshoot when the power is switched on .

Typical Application

(XC9505B092A Input: 2 Cell, Output ①: 3.3V, Output ②: -7.5V)

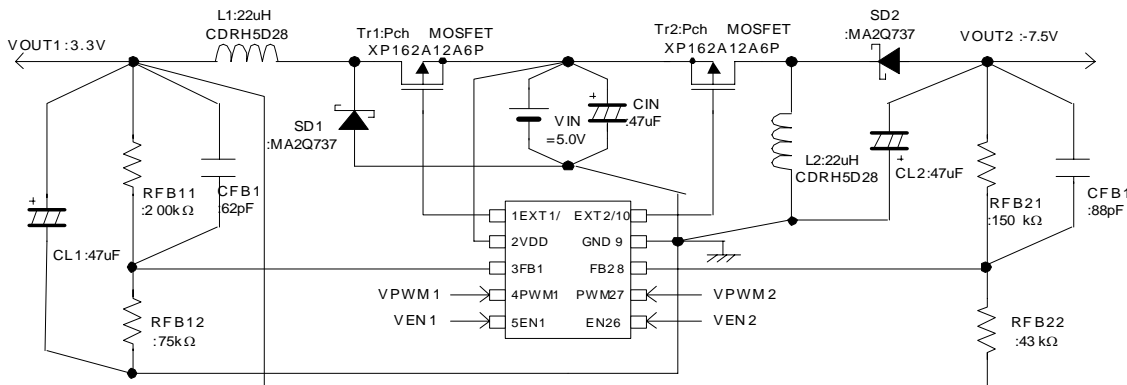

Applications

- PDAs
- Palm Top Computers
- Portable Audio Systems
- Various Multi-function Power Supplies

Features

2ch. DC/DC Controllers

- Output 1: Step-Down DC/DC Controller
- Output 2: Inverting DC/DC Controller

Power Supply Voltage Range 2.0V ~ 10V

Output Voltage Range

- Output 1: 0.9V ~ 6.0V
(Step-Down DC/DC Controller) Can be set freely with 0.9V(±2.0%) of reference voltage supply & external components
- Output 2: -30V ~ 0V
(Inverting DC/DC Controller) Can be set freely with 0.9V(±2.0%) of reference voltage & external components

Oscillation Frequency

- 180kHz ±15%
- 300kHz & 500kHz are available as custom

Output Current

- Output 1 : more than 1000mA (VIN=5.0V, VOUT=3.3V)
- Output 2 : more than -100mA (VIN=5.0V, VOUT=-7.5V)

Soft-Start Internally Set-Up (Output 1)

Stand-By Current 3.0µA (MAX)

Typical Performance Characteristics

XC9505B092A (180kHz, VOUT1:3.3V, VOUT2:-7.5V)

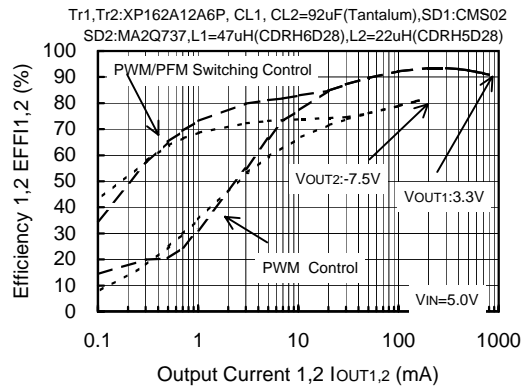

■ Pin Configuration

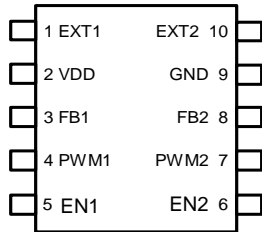

MSOP-10
(TOP VIEW)

■ Pin Assignment

PIN NUMBER	PIN NAME	FUNCTIONS
1	EXT 1	Channel 1: External Transistor Drive Pin <Connected to Pch Power MOSFET Gate>
2	VDD	Supply Voltage
3	FB1	Channel 1 : Output Voltage Monitor Feedback Pin <Threshold value : 0.9V. Output voltage can be set freely by connecting split resistors between VOUT1 and Ground.>
4	PWM1	Channel 1 : PWM/PFM Switching Pin <Control Output 1. PWM control when connected to VDD, PWM / PFM auto switching when connected to Ground. >
5	EN1	Channel 1 : Enable Pin <Connected to Ground when Output 1 is in stand-by mode. Connected to VDD when Output 1 is active. EXT1 is high when in stand-by mode.>
6	EN2	Channel 2 : Enable Pin <Connected to Ground when Output 2 is in stand-by mode. Connected to VDD when Output 2 is active. EXT2/ is high when in stand-by mode.>
7	PWM2	Channel 2 : PWM/PFM Switching Pin <Control Output 2. PWM control when connected to VDD, PWM / PFM auto switching when connected to Ground.>
8	FB2	Channel 2 : Output Voltage Monitor Feedback Pin <Threshold value : 0.9V. Output voltage can be set freely by connecting split resistors between VOUT2 and VOUT1.>
9	GND	Ground
10	EXT2/	Channel 2 : External Transistor Drive Pin <Connected to Pch Power MOSFET Gate>

■ Ordering Information

XC9505①②③④⑤⑥

DESIGNATOR	SYMBOL	DESCRIPTION
①	B	Standard (10 Pin)
②	0	FB Voltage
③	9	0.9V
④		Oscillation Frequency
	2	180kHz
	3	300kHz (custom)
	5	500kHz (custom)
⑤	A	Package MSOP-10
⑥	R	Embossed Tape Standard Feed
	L	Embossed Tape Reverse Feed

■ Block Diagram

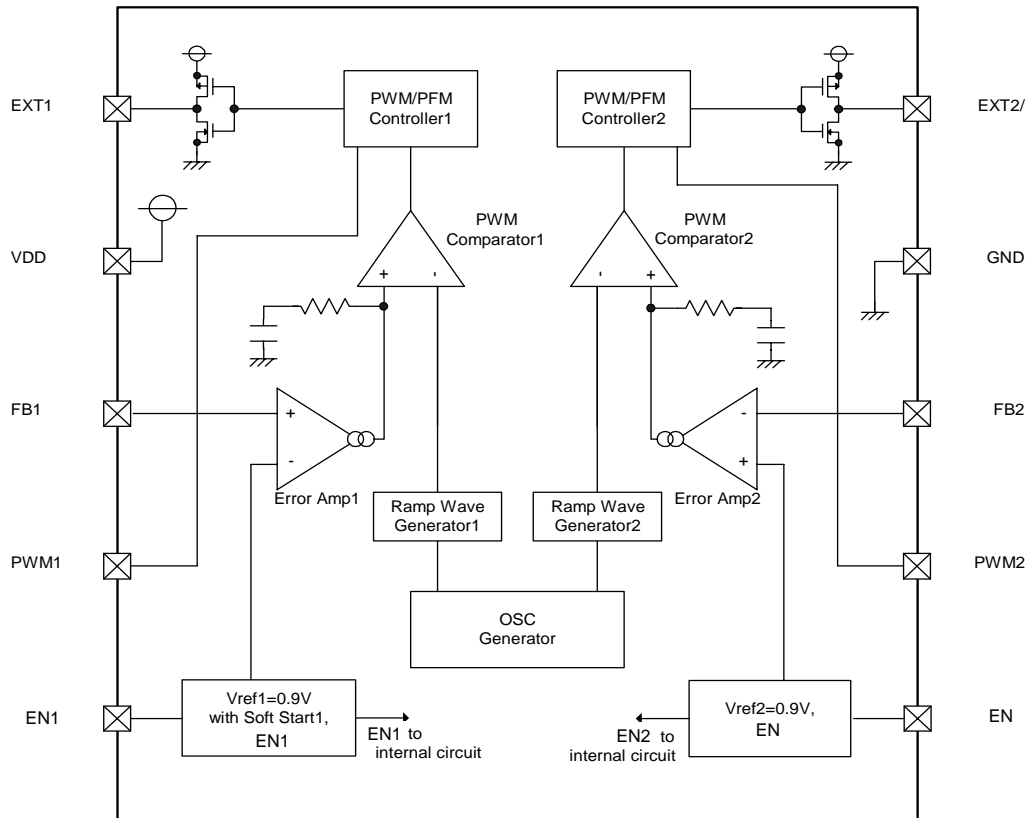

■ Absolute Maximum Ratings

Ta=25°C

PARAMETER	SYMBOL	RATINGS	UNITS
VDD Pin Voltage	VDD	- 0.3 ~ 12	V
FB1, 2 Pin Voltage	VFB	- 0.3 ~ 12	V
EN1, 2 Pin Voltage	VEN	- 0.3 ~ 12	V
PWM1,2 Pin Voltage	VPWM	- 0.3 ~ 12	V
EXT1, 2 Pin Voltage	VEXT	- 0.3 ~ VDD + 0.3	V
EXT1, 2 Pin Current	IEXT	± 100	mA
Power Dissipation	Pd	150	mW
Operating Ambient Temperature	Topr	- 40 ~ + 85	°C
Storage Temperature	Tstg	- 55 ~ + 125	°C

Electrical Characteristics

XC9505B092A

Common Characteristics

Ta=25°C

PARAMETER	SYMBOL	CONDITIONS	MIN.	TYP.	MAX.	UNITS	TEST CIRCUIT
Supply Voltage	VDD		2.0	-	10.0	V	
Output Voltage Range (note 1)	VOUTSET	VDD ≥ 2.0V, IOUT1, 2=1mA	0.9	-	VIN	V	①
Supply Current 1	IDD1	FB=0V, FB2=1.2V	-	80	160	μA	②
Supply Current 1-1	IDD1-1	EN1=3.0V, EN2=0, FB1=0V	-	50	110	μA	②
Supply Current 1-2	IDD1-2	EN2=3.0V, EN1=0, FB2=1.2V	-	60	120	μA	②
Supply Current 1-3	IDD1-3	FB1=0V, FB2=0V	-	70	120	μA	②
Supply Current 1-4	IDD1-4	FB1=1.2V, FB2=1.2V	-	80	150	μA	②
Supply Current 2	IDD2	FB1=1.2V, FB2=0V	-	70	130	μA	②
Stand-by Current	ISTB	Same as IDD1, EN1=EN2=0V	-	1.0	3.0	μA	②
Oscillation Frequency	FOSC	Same as IDD1	153	180	207	kHz	②
EN1, 2 "High" Voltage	VENH	FB1=0V, FB2=3.0V	0.65	-	-	V	②
EN1, 2 "Low" Voltage	VENL	FB1=0V, FB2=3.0V	-	-	0.20	V	②
EN1, 2 "High" Current	IENH	FB1=3.0V, FB2=0V	-	-	0.50	μA	②
EN1, 2 "Low" Current	IENL	EN1, 2=0V, FB1=3.0V, FB2=0V	-	-	-0.50	μA	②
PWM1, 2 "High" Current	IPWMH	FB1=3.0V, FB2=0V, PWM1, 2=3.0V	-	-	0.50	μA	②
PWM1, 2 "Low" Current	IPWML	FB1=3.0V, FB2=0V, PWM1, 2=0V	-	-	-0.50	μA	②
FB1, 2 "High" Current	IFBH	FB1=3.0V, FB2=0.8V	-	-	0.50	μA	②
FB1, 2 "Low" Current	VFBL	FB1=1.0V, FB2=0V	-	-	-0.50	μA	②

Unless otherwise stated, VDD=3.0V, PWM1, 2=3.0V, EN1, 2 = 3.0V

Output 1 Characteristics

Step-Down Controller

Ta=25°C

PARAMETER	SYMBOL	CONDITIONS	MIN.	TYP.	MAX.	UNITS	TEST CIRCUIT
FB1 Voltage	VFB1	VDD=3.0V, VIN=1.5V, IOUT1=10mA	0.882	0.900	0.918	V	③
Minimum Operating Voltage	VINmin1		-	-	2	V	①
Maximum Duty Ratio1	MINDTY1	Same as IDD1	100	-	-	%	②
Minimum Duty Ratio1	MAXDTY2	Same as IDD2	-	-	-	%	②
PFM Duty Ratio1	PFMDTY1	No Load, VPWM1=0V	22	30	38	%	④
Efficiency1 (note 2)	EFFI1	IOUT1= 250mA, Pch MOSFET: XP162A12A6P	-	92	-	%	④
Soft-Start Time1	TSS1	VOUT1 × 0.95V, EN1=0V→0.65V	5.0	10.0	20.0	msec	④
EXT1 "High" ON Resistance	REXTBH1	FB1=0V, EXT1=VDD -0.4V	-	28	47	Ω	⑤
EXT1 "Low" ON Resistance	REXTBL1	EN1=FB1=1.2V, EXT1=0.4V	-	22	30	Ω	⑤
PWM1 "High" Voltage	VPWMH1	No Load	0.65	-	-	V	④
PWM1 "Low" Voltage	VPWML1	No Load	-	-	0.20	V	④

Unless otherwise stated, VDD=EN1=PWM1=3.0V, EN2=PWM2=GND, EXT2=OPEN, FB2=OPEN, VIN=1.8V

Output 2 Characteristics

Inverting DC/DC Controller

Ta=25°C

PARAMETER	SYMBOL	CONDITIONS	MIN.	TYP.	MAX.	UNITS	TEST CIRCUIT
FB2 Voltage	VFB2	VDD=3.0V	0.882	0.900	0.918	V	②
Operation Start-up Voltage2	VST1-2	IOUT2=1.0mA, RFB11=200kΩ, RFB12=75kΩ RFB21=17.5kΩ, RFB22=10kΩ, EN1=PWM1=3.0V	-	-	2.0	V	①
Oscillation Start-up Voltage2	VST2-2	FB2=1.2V	-	-	2.0	V	②
Maximum Duty Ratio2	MAXDTY2	Same as IDD1	75	80	87	%	②
Minimum Duty Ratio2	MINDTY3	Same as IDD2	-	-	0	%	②
PFM Duty Ratio2	PFMDTY2	No Load, VPWM2=0V	22	30	38	%	⑥
Efficiency2 (Note 2)	EFFI2	IOUT2= -150mA, Pch MOSFET: XP162A12A6P	-	76	-	%	⑥
EXT2 "High" ON Resistance	REXTBH2	EN2=FB2= 0V, EXT2=VDD-0.4V	-	28	47	Ω	⑤
EXT2 "Low" ON Resistance	REXTBL2	FB2=3.0V, EXT2=0.4V	-	22	30	Ω	⑤
PWM2 "High" Voltage	VPWMH2	No Load	0.65	-	-	V	⑥
PWM2 "Low" Voltage	VPWML2	No Load	-	-	0.20	V	⑥

Unless otherwise stated, VDD=EN2=PWM2=3.0V, PWM1=EN1=GND, EXT1=OPEN, FB1=OPEN, VIN=3.0V

3) Please be careful not to exceed the breakdown voltage level of the peripheral parts.

4) $EFFI1, 2 = \left\{ \frac{(\text{Output voltage}) \times (\text{Output current})}{(\text{Input voltage}) \times (\text{Input Current})} \right\} \times 100$

Electrical Characteristics

XC9505B093A

Common Characteristics

Ta=25°C

PARAMETER	SYMBOL	CONDITIONS	MIN.	TYP.	MAX.	UNITS	TEST CIRCUIT
Supply Voltage	VDD		2.0	-	10.0	V	
Output Voltage Range (note 1)	VOUTSET	VDD ≥ 2.0V, IOUT1, 2=1mA	VOUT1 VOUT2	0.9 -	VIN 0.0	V	①
Supply Current 1	IDD1	FB=0V, FB2=1.2V	-	100	190	μA	②
Supply Current 1-1	IDD1-1	EN1=3.0V, EN2=0, FB1=0V	-	60	120	μA	②
Supply Current 1-2	IDD1-2	EN2=3.0V, EN1=0, FB2=1.2V	-	80	150	μA	②
Supply Current 1-3	IDD1-3	FB1=0V, FB2=0V	-	80	140	μA	②
Supply Current 1-4	IDD1-4	FB1=1.2V, FB2=1.2V	-	100	180	μA	②
Supply Current 2	IDD2	FB1=1.2V, FB2=0V	-	80	150	μA	②
Stand-by Current	ISTB	Same as IDD1, EN1=EN2=0V	-	1.0	3.0	μA	②
Oscillation Frequency	FOSC	Same as IDD1	255	300	345	kHz	②
EN1, 2 "High" Voltage	VENH	FB1=0V, FB2=3.0V	0.65	-	-	V	②
EN1, 2 "Low" Voltage	VENL	FB1=0V, FB2=3.0V	-	-	0.20	V	②
EN1, 2 "High" Current	IENH	FB1=3.0V, FB2=0V	-	-	0.50	μA	②
EN1, 2 "Low" Current	IENL	EN1, 2=0V, FB1=3.0V, FB2=0V	-	-	-0.50	μA	②
PWM1, 2 "High" Current	IPWMH	FB1=3.0V, FB2=0V, PWM1, 2=3.0V	-	-	0.50	μA	②
PWM1, 2 "Low" Current	IPWML	FB1=3.0V, FB2=0V, PWM1, 2=0V	-	-	-0.50	μA	②
FB1, 2 "High" Current	IFBH	FB1=3.0V, FB2=0.8V	-	-	0.50	μA	②
FB1, 2 "Low" Current	VFBL	FB1=1.0V, FB2=0V	-	-	-0.50	μA	②

Unless otherwise stated, VDD=3.0V, PWM1, 2=3.0V, EN1, 2 = 3.0V

Output 1 Characteristics

Step-Down Controller

Ta=25°C

PARAMETER	SYMBOL	CONDITIONS	MIN.	TYP.	MAX.	UNITS	TEST CIRCUIT
FB1 Voltage	VFB1	VDD=3.0V, VIN=1.5V, IOUT1=10mA	0.882	0.900	0.918	V	③
Minimum Operating Voltage	VINmin1		-	-	2.0	V	①
Maximum Duty Ratio1	MINDTY1	Same as IDD1	-	-	100	%	②
Minimum Duty Ratio1	MAXDTY2	Same as IDD2	-	-	-	%	②
PFM Duty Ratio1	PFMDTY1	No Load, VPWM1=0V	22	30	38	%	④
Efficiency1 (note 2)	EFFI1	IOUT1= 250mA, Pch MOSFET: XP162A12A6P	-	92	-	%	④
Soft-Start Time1	TSS1	VOUT1 × 0.95V, EN1=0V→0.65V	5.0	10.0	20.0	msec	④
EXT1 "High" ON Resistance	REXTBH1	FB1=0V, EXT1=VDD -0.4V	-	28	47	Ω	⑤
EXT1 "Low" ON Resistance	REXTBL1	EN1=FB1=1.2V, EXT1=0.4V	-	22	30	Ω	⑤
PWM1 "High" Voltage	VPWMH1	No Load	0.65	-	-	V	④
PWM1 "Low" Voltage	VPWML1	No Load	-	-	0.20	V	④

Unless otherwise stated, VDD=EN1=PWM1=3.0V, EN2=PWM2=GND, EXT2=OPEN, FB2=OPEN, VIN=1.8V

Output 2 Characteristics

Inverting DC/DC Controller

Ta=25°C

PARAMETER	SYMBOL	CONDITIONS	MIN.	TYP.	MAX.	UNITS	TEST CIRCUIT
FB2 Voltage	VFB2	VDD=3.0V	0.882	0.900	0.918	V	②
Operation Start-up Voltage2	VST1-2	IOUT2=1.0mA, RFB11=200kΩ, RFB12=75kΩ RFB21=17.5kΩ, RFB22=10kΩ, EN1=PWM1=3.0V	-	-	2.0	V	①
Oscillation Start-up Voltage2	VST2-2	FB2=1.2V	-	-	2.0	V	②
Maximum Duty Ratio2	MAXDTY2	Same as IDD1	75	80	87	%	②
Minimum Duty Ratio2	MINDTY3	Same as IDD2	-	-	0	%	②
PFM Duty Ratio2	PFMDTY2	No Load, VPWM2=0V	22	30	38	%	⑥
Efficiency2 (Note 2)	EFFI2	IOUT2= -150mA, Pch MOSFET: XP162A12A6P	-	75	-	%	⑥
EXT2 "High" ON Resistance	REXTBH2	EN2=FB2= 0V, EXT2=VDD-0.4V	-	28	47	Ω	⑤
EXT2 "Low" ON Resistance	REXTBL2	FB2=3.0V, EXT2=0.4V	-	22	30	Ω	⑤
PWM2 "High" Voltage	VPWMH2	No Load	0.65	-	-	V	⑥
PWM2 "Low" Voltage	VPWML2	No Load	-	-	0.20	V	⑥

Unless otherwise stated, VDD=EN2=PWM2=3.0V, PWM1=EN1=GND, EXT1=OPEN, FB1=OPEN, VIN=3.0V

3) Please be careful not to exceed the breakdown voltage level of the peripheral parts.

4) $EFFI1, 2 = \left\{ \frac{(\text{Output voltage}) \times (\text{Output current})}{(\text{Input voltage}) \times (\text{Input Current})} \right\} \times 100$

Electrical Characteristics

XC9505B095A

Common Characteristics

Ta=25°C

PARAMETER	SYMBOL	CONDITIONS	MIN.	TYP.	MAX.	UNITS	TEST CIRCUIT
Supply Voltage	VDD		2.0	-	10.0	V	
Output Voltage Range (note 1)	VOUTSET	VDD ≥ 2.0V, IOUT1, 2=1mA	VOUT1 VOUT2	0.9 -	- 0.0	V	①
Supply Current 1	IDD1	FB=0V, FB2=1.2V	-	130	250	μA	②
Supply Current 1-1	IDD1-1	EN1=3.0V, EN2=0, FB1=0V	-	80	150	μA	②
Supply Current 1-2	IDD1-2	EN2=3.0V, EN1=0, FB2=1.2V	-	110	220	μA	②
Supply Current 1-3	IDD1-3	FB1=0V, FB2=0V	-	100	170	μA	②
Supply Current 1-4	IDD1-4	FB1=1.2V, FB2=1.2V	-	140	230	μA	②
Supply Current 2	IDD2	FB1=1.2V, FB2=0V	-	100	190	μA	②
Stand-by Current	ISTB	Same as IDD1, EN1=EN2=0V	-	1.0	3.0	μA	②
Oscillation Frequency	FOSC	Same as IDD1	425	500	575	kHz	②
EN1, 2 "High" Voltage	VENH	FB1=0V, FB2=3.0V	0.65	-	-	V	②
EN1, 2 "Low" Voltage	VENL	FB1=0V, FB2=3.0V	-	-	0.20	V	②
EN1, 2 "High" Current	IENH	FB1=3.0V, FB2=0V	-	-	0.50	μA	②
EN1, 2 "Low" Current	IENL	EN1, 2=0V, FB1=3.0V, FB2=0V	-	-	-0.50	μA	②
PWM1, 2 "High" Current	IPWMH	FB1=3.0V, FB2=0V, PWM1, 2=3.0V	-	-	0.50	μA	②
PWM1, 2 "Low" Current	IPWML	FB1=3.0V, FB2=0V, PWM1, 2=0V	-	-	-0.50	μA	②
FB1, 2 "High" Current	IFBH	FB1=3.0V, FB2=0.8V	-	-	0.50	μA	②
FB1, 2 "Low" Current	VFBL	FB1=1.0V, FB2=0V	-	-	-0.50	μA	②

Unless otherwise stated, VDD=3.0V, PWM1, 2=3.0V, EN1, 2 = 3.0V

Output 1 Characteristics

Step-Down Controller

Ta=25°C

PARAMETER	SYMBOL	CONDITIONS	MIN.	TYP.	MAX.	UNITS	TEST CIRCUIT
FB1 Voltage	VFB1	VDD=3.0V, VIN=1.5V, IOUT1=10mA	0.882	0.900	0.918	V	③
Minimum Operating Voltage	VINmin1		-	-	2.0	V	①
Maximum Duty Ratio1	MINDTY1	Same as IDD1	-	-	100	%	②
Minimum Duty Ratio1	MAXDTY2	Same as IDD2	-	-	-	%	②
PFM Duty Ratio1	PFMDTY1	No Load, VPWM1=0V	22	30	38	%	④
Efficiency1 (note 2)	EFFI1	IOUT1= 250mA, Pch MOSFET: XP162A12A6P	-	91	-	%	④
Soft-Start Time1	TSS1	VOUT1 × 0.95V, EN1=0V→0.65V	5.0	10.0	20.0	msec	④
EXT1 "High" ON Resistance	REXTBH1	FB1=0V, EXT1=VDD -0.4V	-	28	47	Ω	⑤
EXT1 "Low" ON Resistance	REXTBL1	EN1=FB1=1.2V, EXT1=0.4V	-	22	30	Ω	⑤
PWM1 "High" Voltage	VPWMH1	No Load	0.65	-	-	V	④
PWM1 "Low" Voltage	VPWML1	No Load	-	-	0.20	V	④

Unless otherwise stated, VDD=EN1=PWM1=3.0V, EN2=PWM2=GND, EXT2=OPEN, FB2=OPEN, VIN=1.8V

Output 2 Characteristics

Inverting DC/DC Controller

Ta=25°C

PARAMETER	SYMBOL	CONDITIONS	MIN.	TYP.	MAX.	UNITS	TEST CIRCUIT
FB2 Voltage	VFB2	VDD=3.0V	0.882	0.900	0.918	V	②
Operation Start-up Voltage2	VST1-2	IOUT2=1.0mA, RFB11=200kΩ, RFB12=75kΩ RFB21=17.5kΩ, RFB22=10kΩ, EN1=PWM1=3.0V	-	-	2.0	V	①
Oscillation Start-up Voltage2	VST2-2	FB2=1.2V	-	-	2.0	V	②
Maximum Duty Ratio2	MAXDTY2	Same as IDD1	75	80	87	%	②
Minimum Duty Ratio2	MINDTY3	Same as IDD2	-	-	0	%	②
PFM Duty Ratio2	PFMDTY2	No Load, VPWM2=0V	22	30	38	%	⑥
Efficiency2 (Note 2)	EFFI2	IOUT2= -150mA, Pch MOSFET: XP162A12A6P	-	71	-	%	⑥
EXT2 "High" ON Resistance	REXTBH2	EN2=FB2= 0V, EXT2=VDD-0.4V	-	28	47	Ω	⑤
EXT2 "Low" ON Resistance	REXTBL2	FB2=3.0V, EXT2=0.4V	-	22	30	Ω	⑤
PWM2 "High" Voltage	VPWMH2	No Load	0.65	-	-	V	⑥
PWM2 "Low" Voltage	VPWML2	No Load	-	-	0.20	V	⑥

Unless otherwise stated, VDD=EN2=PWM2=3.0V, PWM1=EN1=GND, EXT1=OPEN, FB1=OPEN, VIN=3.0V

3) Please be careful not to exceed the breakdown voltage level of the peripheral parts.

4) $EFFI1, 2 = \left\{ \frac{(\text{Output voltage}) \times (\text{Output current})}{(\text{Input voltage}) \times (\text{Input Current})} \right\} \times 100$

■ Operational Description

The XC9505 series are dual DC/DC (step-down + inverting) converter controller ICs with built-in high speed, low ON resistance buffers.

<Error Amp. 1>

Error Amplifier 1 is designed to monitor the output voltage and it compares the feedback voltage 1 (FB1) with the reference voltage Vref1. In response to feedback of a voltage lower than the reference voltage Vref1, the output voltage of the error amp. decreases.

<Error Amp. 2>

Error Amplifier 2 is designed to monitor the output voltage and it compares the feedback voltage 2 (FB2) with the reference voltage Vref 2. In response to feedback of a voltage lower than the reference voltage Vref2, the output voltage of the error amp. decreases.

<OSC Generator>

This circuit generates the internal reference clock.

<Ramp Wave Generator 1, 2>

The Ramp Wave Generator generates a saw-tooth waveform based on outputs from the OSC Generator.

<PWM Comparator 1, 2>

The PWM Comparator compares outputs from the Error Amp. and saw-tooth waveform. When the voltage from the Error Amp's output is low, the external switch will be set to ON.

<PWM/PFM Controller 1, 2>

This circuit generates PFM pulses.

Control can be switched between PWM control and PWM/PFM automatic switching control using external signals.

The PFM/PWM automatic switching mode is selected when the voltage of the PWM1 (2) pin is less than 0.2V, and the control switches between PWM and PFM automatically depending on the load. As the PFM circuit generates pulses based on outputs from the PWM Comparator, shifting between modes occurs smoothly. PWM control mode is selected when the voltage of the PWM1 (2) pin is more than 0.65V. Noise is easily reduced with PWM control since the switching frequency is fixed.

Control suited to the application can easily be selected which is useful in audio applications, for example, where traditionally, efficiencies have been sacrificed during stand-by as a result of using PWM control (due to the noise problems associated with the PFM mode in stand-by).

<Vref 1 with Soft Start 1>

The reference voltage, Vref1(FB1 pin voltage)=0.9V, is adjusted and fixed by laser trimming (for output voltage settings, please refer to the functional settings notes on page 9.). To protect against inrush current, when the power is switched on, and also to protect against voltage overshoot, soft-start time is set internally to 10ms. It should be noted, however, that this circuit does not protect the load capacitor (CL) from inrush current. With the Vref voltage limited, and depending upon the input to error amp 1, the operation maintains a balance between the two inputs of error amps and controls the EXT pin's ON time so that it doesn't increase more than is necessary.

<Vref 2>

The reference voltage, Vref2 (FB2 pin voltage)=0.9V, is adjusted and fixed by laser trimming.

<Enable Function 1,2>

This function controls the operation and shutdown of the IC. When the voltage of the EN1 or EN2 pins is 0.2V or less, the mode will be disable, the channel's operations will stop and the EXT1 and the EXT2 pin will be kept at a high level (the external P-type MOSFET will be OFF). When both EN1 and EN2 are in a state of chip disable, current consumption will be no more than 3.0 μ A. When the EN1 or EN2 pin's voltage is 0.65V or more, the mode will be enable and operations will recommence. With channel one (output 1) soft-start, 95% of the set output voltage will be reached within 10msec (TYP) from the moment of enable.

■ Functional Settings

< Output Voltage Setting, Ch.1 (Step-up DC/DC Converter Controller) >

Output voltage can be set by adding external split resistors. Output voltage is determined by the following equation, based on the values of RFB11 and RFB12. The sum of RFB11 and RFB12 should normally be 1 MΩ or less.

$$V_{OUT1} = 0.9 \times (R_{FB11} + R_{FB12}) / R_{FB12}$$

The speed-up capacitor for phase compensation's (CFB1) value should be adjusted using the formula $f_{zfb} = 1 / (2 \times \pi \times C_{FB1} \times R_{FB11})$ so that it equals 12kHz. Depending on the application, the inductance value L, and the load capacity value CL, adjustments to this value are suggested so that the value is somewhere between 1kHz to 50kHz.

[Calculation Example]

When RFB11=220kΩ and RFB12=75kΩ : $V_{OUT1} = 0.9 \times (200k + 75k) / 75k = 3.3V$.

[Typical Example]

VOUT (V)	RFB11 (kΩ)	RFB12 (kΩ)	CFB1 (pF)	VOUT (V)	RFB11 (kΩ)	RFB12 (kΩ)	CFB1 (pF)
1.0	30	270	430	2.5	390	220	33
1.5	220	330	62	2.7	360	180	33
1.8	220	220	62	3.0	560	240	24
2.0	330	270	39	3.3	200	75	62
2.2	390	270	33	5.0	82	18	160

< Output Voltage Setting, Ch.2 (Inverting DC/DC Converter) >

Output voltage can be set by adding reference voltage and split resistors externally. Output voltage is determined using the following equation and is based on the values of RFB21 and RFB22. The sum of RFB21 and RFB22 should normally be 500kΩ or less. The equation uses Ch 1's (VOUT1) output voltage calculation method for the reference voltage.

$$V_{OUT2} = (0.9 - V_{OUT1}) \times (R_{FB21} / R_{FB22}) + 0.9V$$

[Calculation Example]

When RFB21=17.5kΩ, RFB22=10kΩ, VOUT1=3.3V, VOUT2= - 3.3V

The value of speed-up capacitor for phase compensation CFB21 :

[Conditions: Heavy load (when coil current is continuous.)]

$$f_{zfb2} = 1/2 \times \pi \times C_{FB21} \times R_{FB21} = 10kHz$$

Depending on the application, the inductance value L, and the load capacity value CL, adjustments to this value are suggested so that the value is somewhere between 1kHz to 50kHz.

[Conditions: Light load (when coil current is discontinuous.)]

Less than CFB21=0.1μF

Depending on the application, the inductance value L, and the load capacity value CL, adjustments to this value are suggested.

> Example Circuit 1 : Using voltage of Ch 1 (Step-Down)

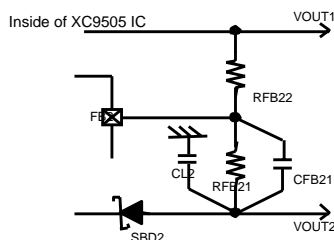

Channel 1 (Step-Down) circuits should be enable by setting EN1 to High level so that a stable voltage is provided. Inrush current to the inverter when the supply voltage VDD of the IC is 2.0 V or higher can be controlled by setting EN 1 and EN 2 to enable ("H" level) simultaneously.

> Example Circuit 1 : Using a positive regulator

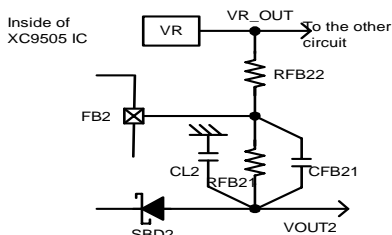

A stable positive voltage produced by a positive-voltage regulator or by other means is usable.

$$V_{OUT2} = (0.9 - V_{ROUT}) \times (R_{FB21} / R_{FB22}) + 0.9V$$

External Components

Conditions : Light load (when coil current is discontinuous.)

Channel One (Step-Down DC/DC Converter Controller)

Tr 1 :	* MOSFET XP152A12C0 (TOREX P-Channel Power MOSFET)	
	Note : VGS Breakdown Voltage of this Tr. is 12V so please be careful with the power supply voltage.	
SD 1 :	CRS02	(Schottky , TOSHIBA)
L1 :	10 μ H	(SUMIDA, CDRH4D18C, TOKO, D412F, FOSC = 500kHz)
	15 μ H	(SUMIDA, CDRH4D18C, TOKO, D412F, FOSC = 300kHz)
	22 μ H	(SUMIDA, CDRH4D18C, TOKO, D412F, FOSC = 180kHz)
	Please set so that the coil current is discontinuous.	
CL1 :	10V, 4.7 μ F	(Ceramic)
	*PNP Tr	
RB1 :	2SA1213	(TOSHIBA)
	500 Ω	Adjust in accordance with load & Tr.'s HFE
		$RB1 \leq (VIN-0.7) \times (hFE/IC-REXTBL)$
CB1 :	2200pF	(Ceramic)
		$CB1 \leq (2\pi \times RB2 \times FOSC \times 0.7)$

Channel Two (Inverter DC/DC Controller)

Tr 2 :	* MOSFET XP152A12C0 (TOREX P-Channel Power MOSFET)	
	Note : VGS Breakdown Voltage of this Tr. is 12V so please be careful with the power supply voltage.	
SD 2 :	CRS02	(Schottky, TOSHIBA)
L2 :	10 μ H	(SUMIDA, CDRH4D18C, TOKO, D412F, FOSC = 500kHz)
	15 μ H	(SUMIDA, CDRH4D18C, TOKO, D412F, FOSC = 300kHz)
	22 μ H	(SUMIDA, CDRH4D18C, TOKO, D412F, FOSC = 180kHz)
	Please set so that the coil current is discontinuous.	
CL2 :	10V, 4.7 μ F	(Ceramic)
	*PNP Tr	
RB 2 :	2SA1213	(TOSHIBA)
	500 Ω	Adjust in accordance with load & Tr.'s HFE
		$RB2 \leq (VIN-0.7) \times (hFE/IC-REXTBL)$
CB 2 :	2200pF	(Ceramic)
		$CB2 \leq (2\pi \times RB2 \times FOSC \times 0.7)$

Conditions: Heavy load (when coil current is continuous.)

Channel One (Step-Down DC/DC Converter Controller)

Tr 1 :	* MOSFET XP162A12A6P (TOREX P-Channel Power MOSFET)	
	Note : VGS Breakdown Voltage of this Tr. is 12V so please be careful with the power supply voltage.	
SD 1 :	MA2Q737	(Schottky , MATSUSHITA)
	CMS02	(Schottky , TOSHIBA)
L1 :	10 μ H	(SUMIDA, CDRH5D28, FOSC = 500kHz)
	22 μ H	(SUMIDA, CDRH5D28, FOSC = 300kHz)
	47 μ H	(SUMIDA, CDRH5D28, FOSC = 180kHz)
CL1 :	16V, 47 μ F	(Tantalum)
	Increase capacity according to the equation below when the step-up voltage ratio is large and output current is high.	
	$CL = (CL \text{ standard value}) \times (IOUT1 \text{ (mA)} / 500\text{mA} \times VOUT1 / VIN)$	
	*PNP Tr	
RB1 :	2SA1213	(TOSHIBASANYO)
	500 Ω	Adjust in accordance with load & Tr.'s HFE
		$RB1 \leq (VIN-0.7) \times (hFE/IC-REXTBL)$
CB1 :	2200pF	(Ceramic)
		$CB1 \leq (2\pi \times RB2 \times FOSC \times 0.7)$

Channel Two (Inverter DC/DC Controller)

Tr 2 :	* MOSFET XP162A12A6P (TOREX P-Channel Power MOSFET)	
	Note : VGS Breakdown Voltage of this Tr. is 12V so please be careful with the power supply voltage.	
SD 2 :	MA2Q737	(Schottky, MATSUSHITA)
	CRS02, CMS02	(Schottky , TOSHIBA)
L2 :	10 μ H	(SUMIDA, CDRH5D28, FOSC = 500kHz)
	15 μ H	(SUMIDA, CDRH5D28, FOSC = 300kHz)
	22 μ H	(SUMIDA, CDRH5D28, FOSC = 180kHz)
CL2 :	16V, 47 μ F	(Tantalum)
	Increase capacity according to the equation below when the step-up voltage ratio is large and output current is high.	
	$CL = (CL \text{ standard value}) \times (IOUT2 \text{ (mA)} / 150\text{mA} \times VOUT2 / VIN)$	
	*PNP Tr	
RB 2 :	2SA1213	(TOSHIBA)
	500 Ω	Adjust in accordance with load & Tr.'s HFE
		$RB2 \leq (VIN-0.7) \times (hFE/IC-REXTBL)$
CB 2 :	2200pF	(Ceramic)
		$CB2 \leq (2\pi \times RB2 \times FOSC \times 0.7)$

■ Notes on how to use

○ Hint on application

1. Channel 2 (Inverting) Soft start circuit

Channel 2 (inverting) is subject to the overshoot of output voltage 2 (VOUT 2) at start-up. It is possible to control the overshoot of output voltage 2 (VOUT 2), as shown by circuit example 1 in "Output Voltage Settings for Channel 2" in "Function Settings." In this circuit configuration, EN 1 and EN 2 are enabled (set to "H" level) simultaneously. This lets output voltage 1 (VOUT 1) of channel 1 increase gently as soft start, thereby controlling the overshoot.

> Example of typical application circuit : Improved Soft start

This example is effective when EN 1 and EN 2 are enabled with different timings under light load condition (the coil current being discontinuous).

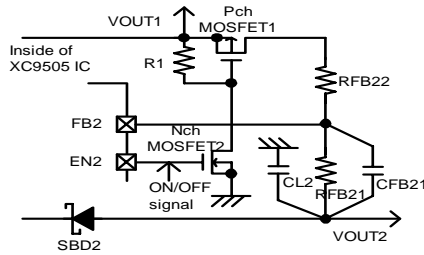

Time to make soft start time is calculated by the equation below.

$$Time_{SS2} = -R_{FB21} \times C_{CFB21} / Ln \left[1 - \frac{(0.9 - V_{OUT2}) \times R_{FB22}}{(V_{OUT1} - 0.9) \times R_{FB21}} \right]$$

Example)

When VOUT1 = 3.3V and VOUT2 = - 7.5V,

RFB21 = 350kΩ, RFB22 = 100kΩ by the equation below.

VOUT2 = (0.9 - VOUT1) x (RFB21 / RFB22) + 0.9

When the light load, CFB21=0.1μF or lower value can be used.

Therefore, when CFB21=0.027μF,

Time_ss2 = 5.0mS and VOUT2 = 95% of setting value

2. Channel 2 (Inverting) Withstand voltage of transistor

The voltage applied between the drain and source is the sum of VIN and VOUT 2.

Select a transistor with an absolute VDSS rating that is suitable for your operating conditions.

Example: The voltage applied across VDS of a transistor will be 20.0V if VIN = 5.0 V and VOUT 2 = -15.0 V.

Under this condition, a transistor with VDSS higher than 20.0V should be selected. (Use a transistor with VDSS that is 1.5 times the applied voltage or more, as a standard.)

■ Test Circuits

Circuit 1

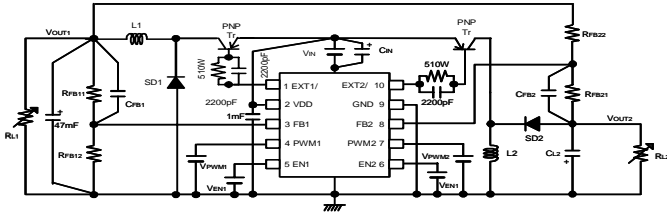

Circuit 4

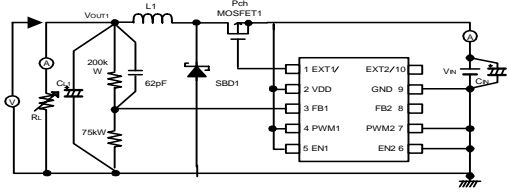

Circuit 2

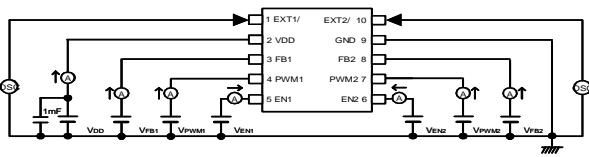

Circuit 5

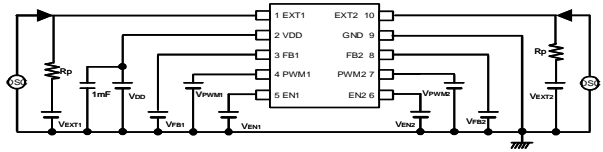

Circuit 3

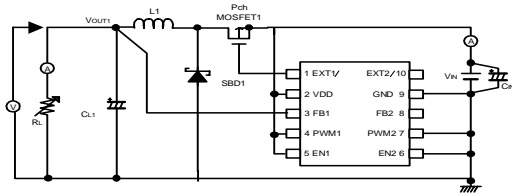

Circuit 6

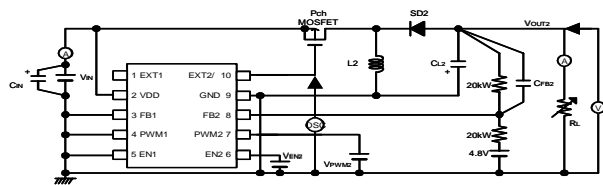

External Components of the Test Circuits

Circuits 1

L1, L2: 22 μ H (SUMIDA CDRH5D28) : XC9505B092A
 15 μ H (SUMIDA CDRH5D28) : XC9505B093A
 10 μ H (SUMIDA CDRH5D28) : XC9505B095A
 SD1, SD2: CRS02 (Schottky, TOSHIBA)
 EC10QS06 (Schottky, NIHON INTER)
 CL1, CL2: 16MCE476MD2 (Tantalum, NIHON CHEMICON)
 35MCE335MB x 3 (Tantalum, NIHON CHEMICON)
 CIN : 16MCE476MD2
 PNP Tr 1 : 2SA1213 (TOSHIBA)
 PNP Tr 2 : 2SA1213 (TOSHIBA)
 RFB : Please use by the conditions as below.
 $RFB11 + RFB12 \leq 1M\Omega$
 $RFB21 + RFB22 \leq 1M\Omega$
 $RFB11 / RFB12 = (\text{Setting Output Voltage} / 0.9) - 1$
 $VOUT2 = (0.9 - VOUT1) / (RFB21 / RFB22) + 0.9V$
 CFB : $fzfb = 1 / (2 \times \pi \times CFB1 \times RFB11) = 1\text{kHz to } 50\text{kHz (12kHz usual)}$
 $fzfb = 1 / (2 \times \pi \times CFB2 \times RFB21) = 1\text{kHz to } 50\text{kHz (12kHz usual)}$

Circuits 3

L1 : 22 μ H (SUMIDA CDRH5D28)
 SD 1 : MA2Q737 (Schottky, MATSUSHITA)
 CL 1 : 16MCE476MD2 (Tantalum, NIHONCHEMICON)
 CIN : 16MCE476MD2 (Tantalum, NIHONCHEMICON)
 Pch MOSFET : XP162A12A6P (TOREX)

Circuits 4

L1 : 22 μ H (SUMIDA CDRH5D28) : XC9505B092A
 15 μ H (SUMIDA CDRH5D28) : XC9505B093A
 10 μ H (SUMIDA CDRH5D28) : XC9505B095A
 SD 1 : MA2Q737 (Schottky, MATSUSHITA)
 CL 1 : 16MCE476MD2 (Tantalum, NIHONCHEMICON)
 CIN : 16MCE476MD2 (Tantalum, NIHONCHEMICON)
 Pch MOSFET : XP162A12A6P (TOREX)

Circuits 6

L2 : 22 μ H (SUMIDA CDRH5D28) : XC9505B092A
 15 μ H (SUMIDA CDRH5D28) : XC9505B093A
 10 μ H (SUMIDA CDRH5D28) : XC9505B095A
 SD 2 : MA2Q737 (Schottky, MATSUSHITA)
 CL 2 : 16MCE476MD2 (Tantalum, NIHONCHEMICON)
 CIN : 16MCE476MD2 (Tantalum, NIHONCHEMICON)
 Pch MOSFET : XP162A12A6P (TOREX)

■ Note on Use

1. Checking for Intermittent Oscillation

The XC9505 series is subject to intermittent oscillation in the proximity of the maximum duty if the step-down ratio is low (e.g., from 4.2 V to 3.3 V) or a heavy load is applied where the duty ratio becomes high. Check waveforms at EXT under your operating conditions. A remedy for this problem is to raise the inductance of coil L or increase the load capacitance CL.

2. PWM/PFM Automatic Switching

If PWM/PFM automatic switching control is selected and the step-down ratio is high (e.g., from 10.0 V to 1.0 V), the control mode remains in PFM setting over the whole load range, since the duty ratio under continuous-duty condition is smaller than the PFM duty ratio of the XC9505series. The output voltage's ripple voltage becomes substantially high under heavy load conditions, with the XC9505 series appearing to be producing an abnormal oscillation. If this operation becomes a concern, set pins PWM to High to set the control mode to PWM setting. For use under the above-mentioned condition, measured data of PWM/PFM automatic switching control shown on the data sheets are available up to IO_{UT} = 100 mA.

3. Ratings

Use the XC9505 series and peripheral components within the limits of their ratings.

Typical Performance Characteristics < 1ch Step-Down DC/DC Controller >

(1) Output Voltage vs. Output Current

FOSC=180kHz, V_{OUT1}=1.0V

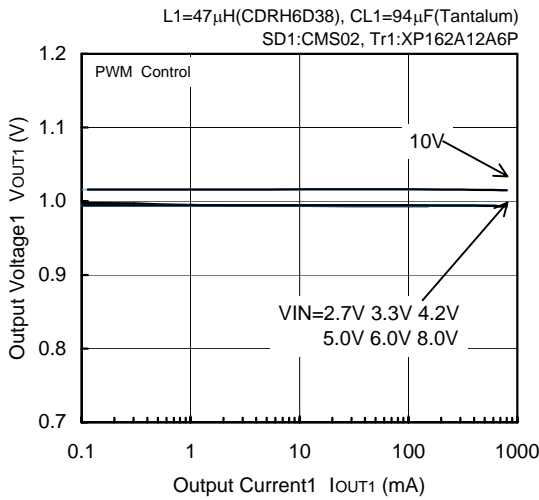

FOSC=180kHz, V_{OUT1}=1.0V

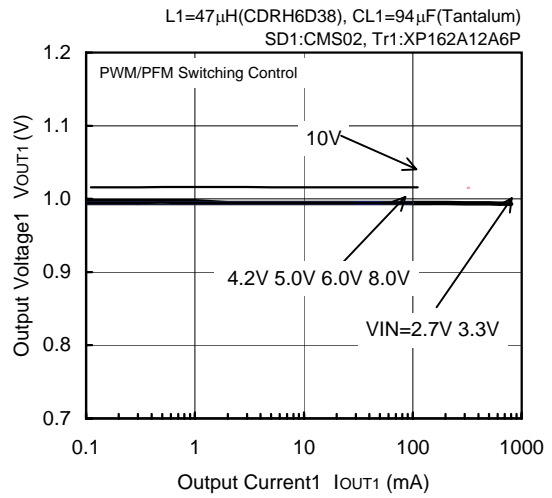

FOSC=180kHz, V_{OUT1}=3.3V

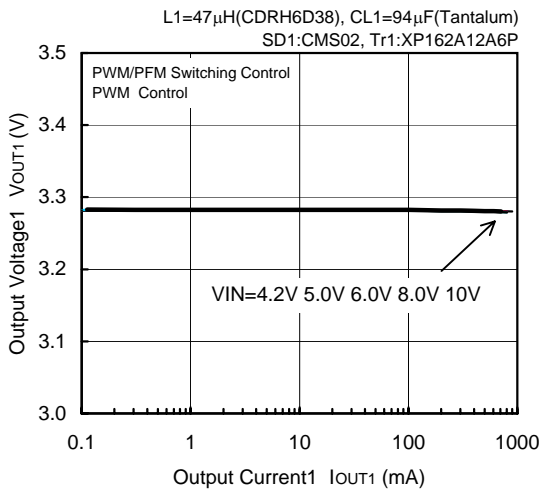

FOSC=180kHz, V_{OUT1}=5.0V

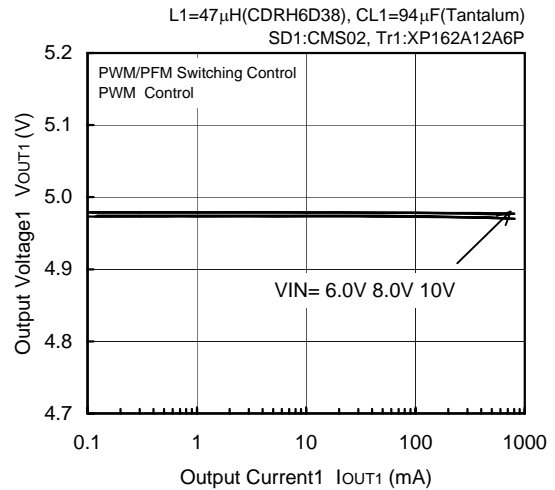

FOSC=300kHz, V_{OUT1}=1.0V

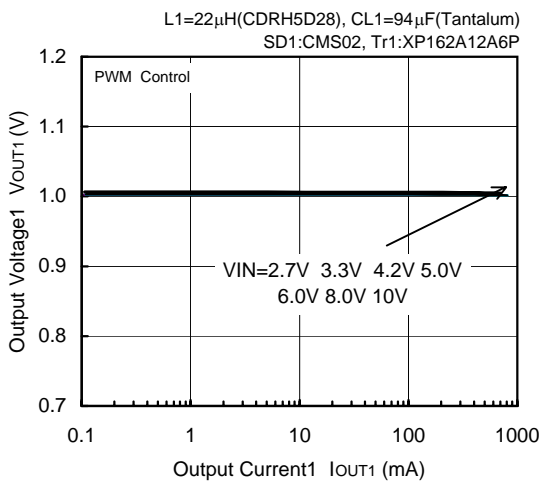

FOSC=300kHz, V_{OUT1}=1.0V

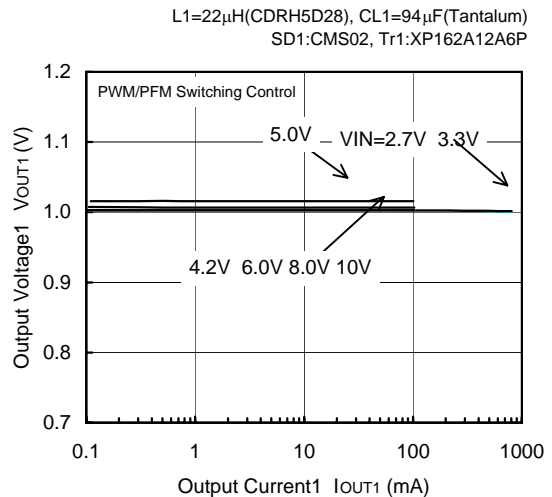

* When setting V_{OUT1}=1.0V, V_{IN}=8.0V or 10.0V,
CL=94μF (Tantalum) + 100μF (OS Capacitor)

< 1ch Step-Down DC/DC Controller >

(1) Output Voltage vs. Output Current (Continued)

FOSC=300kHz, V_{OUT1}=1.8V

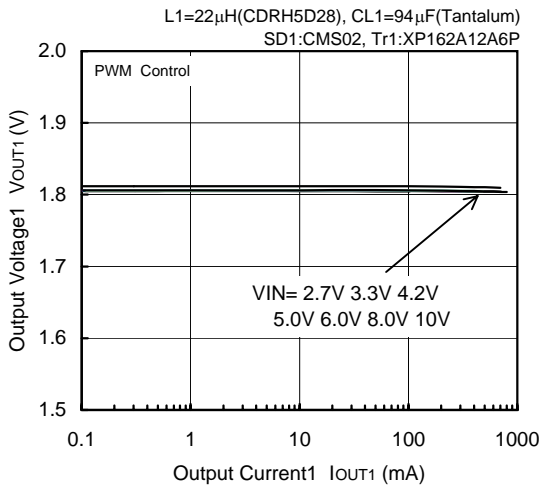

FOSC=300kHz, V_{OUT1}=1.8V

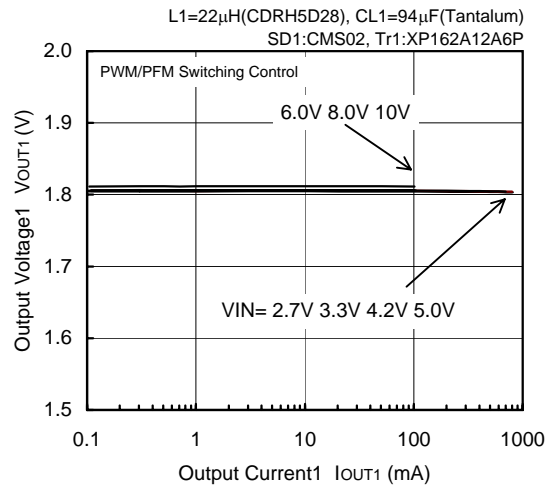

FOSC=300kHz, V_{OUT1}=2.5V

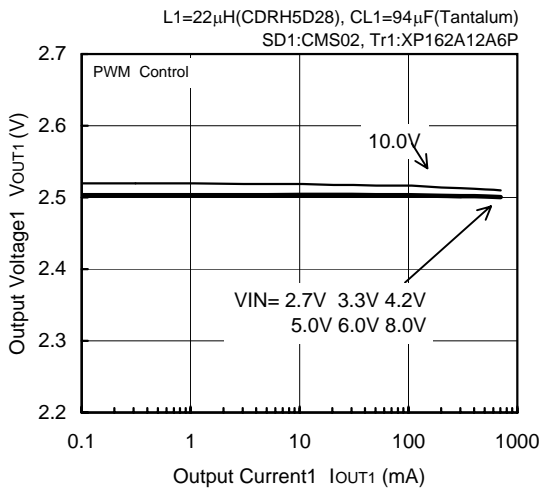

FOSC=300kHz, V_{OUT1}=2.5V

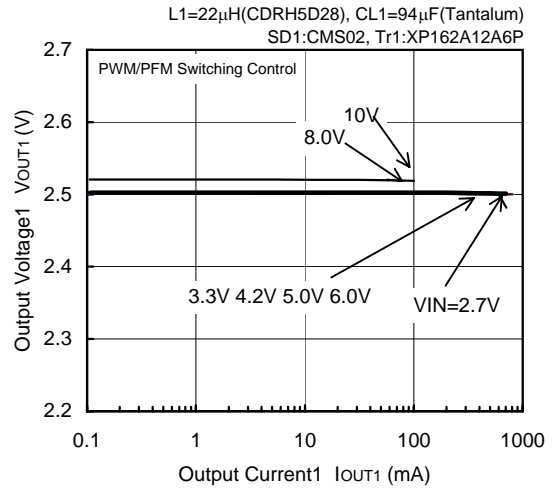

FOSC=300kHz, V_{OUT1}=3.3V

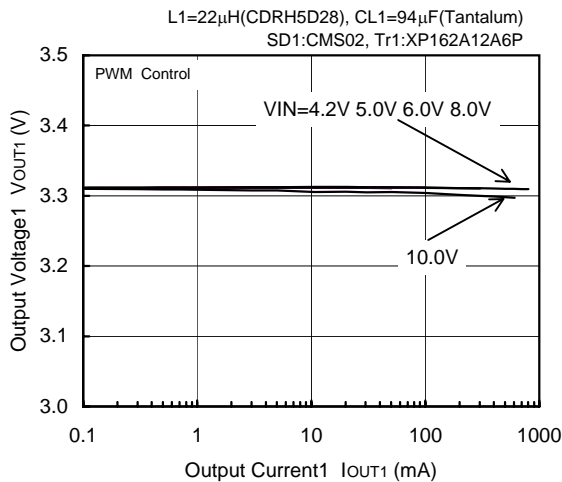

FOSC=300kHz, V_{OUT1}=3.3V

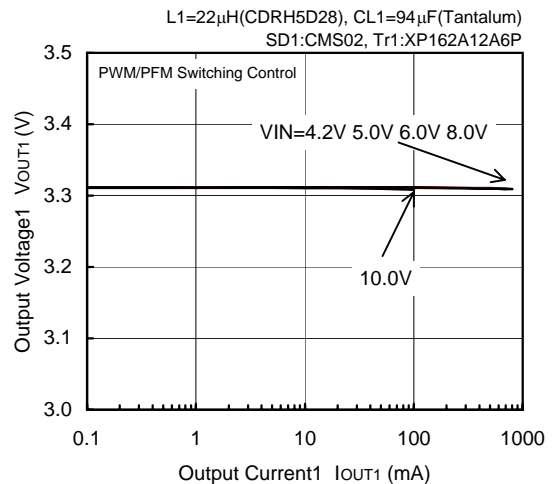

* When setting V_{OUT1}=1.0V, V_{IN}=8.0V or 10.0V,
CL=94 μ F (Tantalum) + 100 μ F (OS Capacitor)

< 1ch Step-Down DC/DC Controller >

(1) Output Voltage vs. Output Current (Continued)

FOSC=300kHz, VOUT1=5.0V

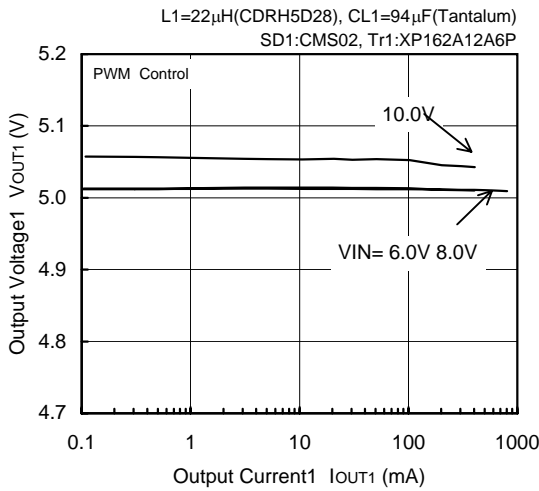

FOSC=300kHz, VOUT1=5.0V

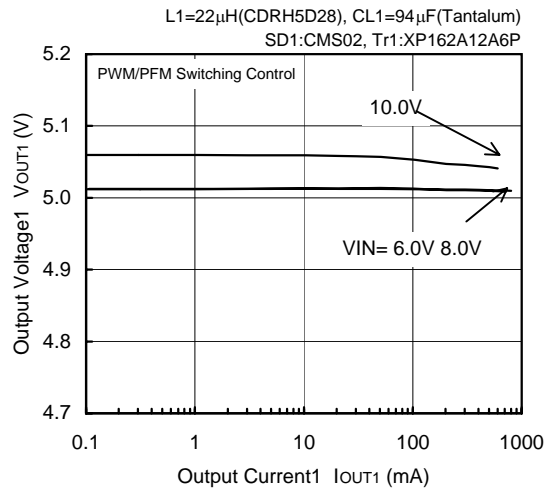

FOSC=500kHz, VOUT1=1.0V

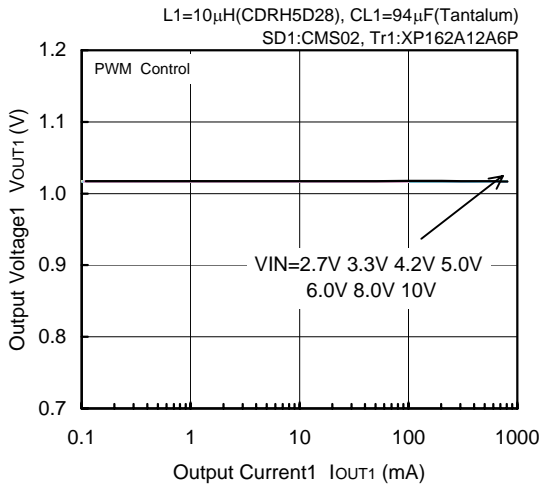

FOSC=500kHz, VOUT1=1.0V

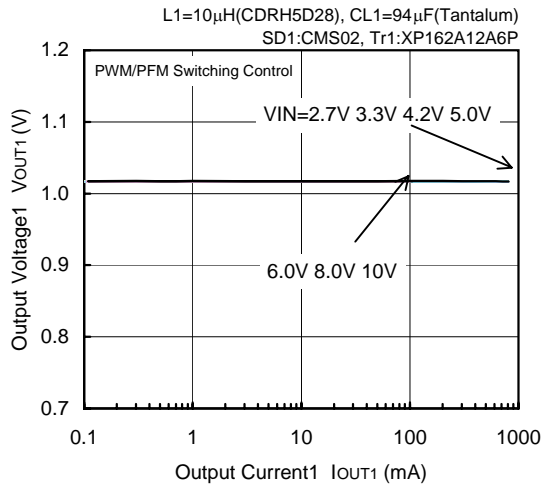

FOSC=500kHz, VOUT1=3.3V

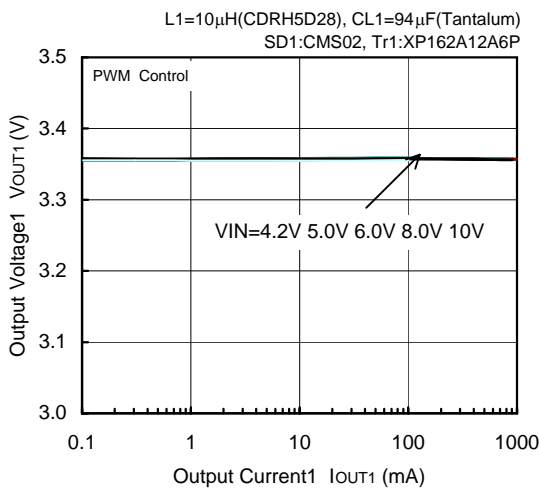

FOSC=500kHz, VOUT1=3.3V

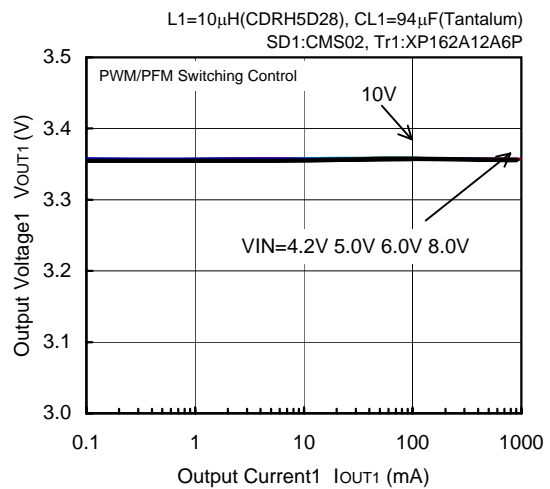

* When setting VOUT1=1.0V, VIN=8.0V or 10.0V,
CL=94 μ F (Tantalum) + 100 μ F (OS Capacitor)

< 1ch Step-Down DC/DC Controller >

(1) Output Voltage vs. Output Current (Continued)

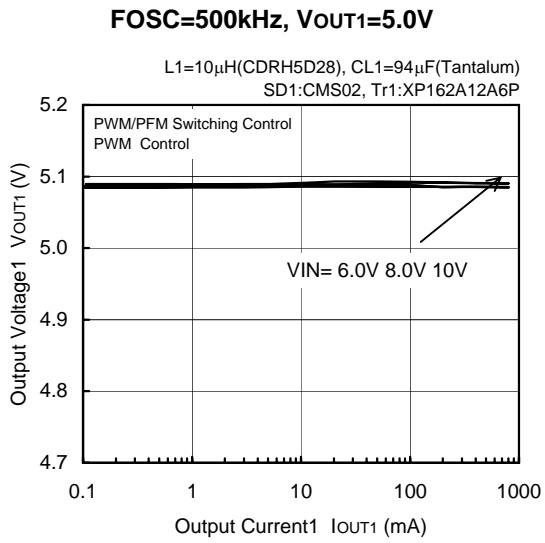

* When setting V_{OUT1}=1.0V, V_{IN}=8.0V or 10.0V,
CL=94 μ F (Tantalum) + 100 μ F (OS Capacitor)

< 1ch Step-Down DC/DC Controller >

(2) Efficiency vs. Output Current

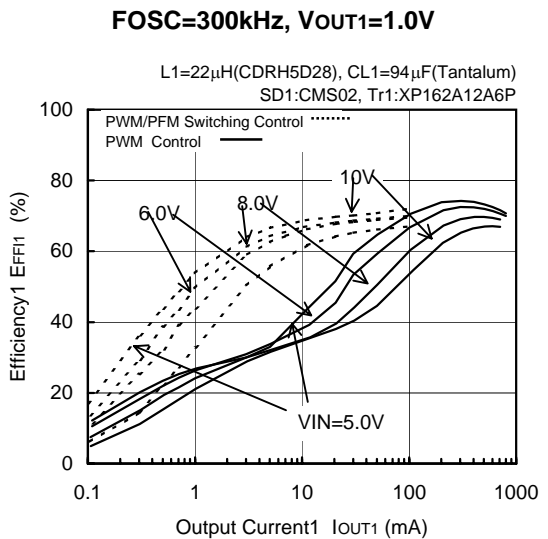
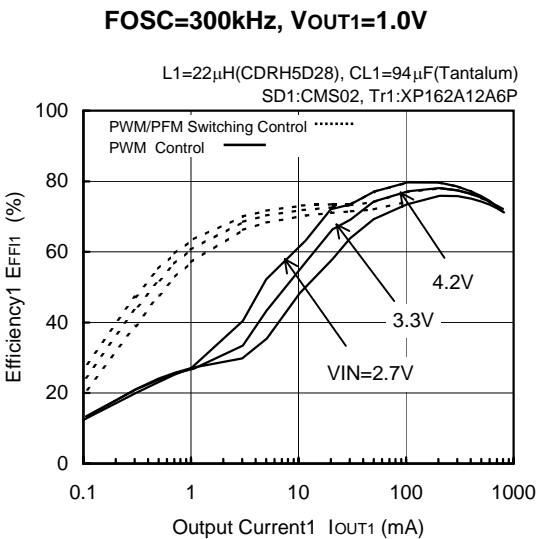
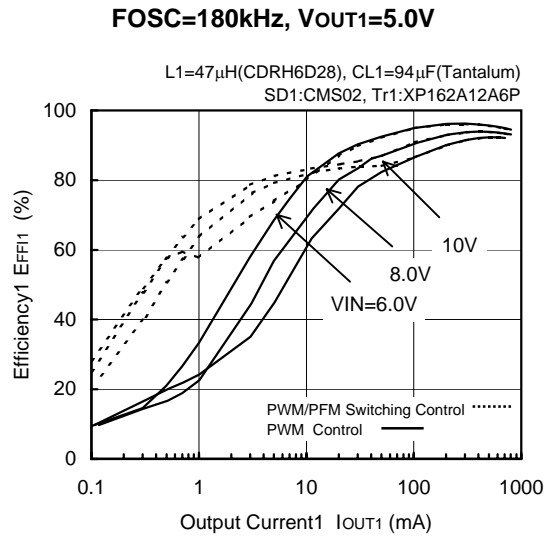
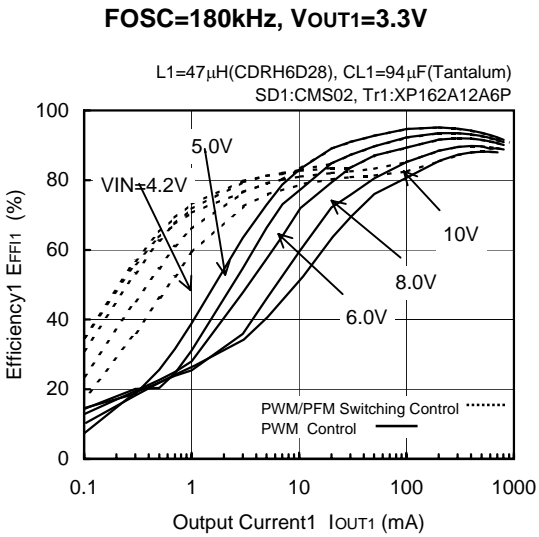
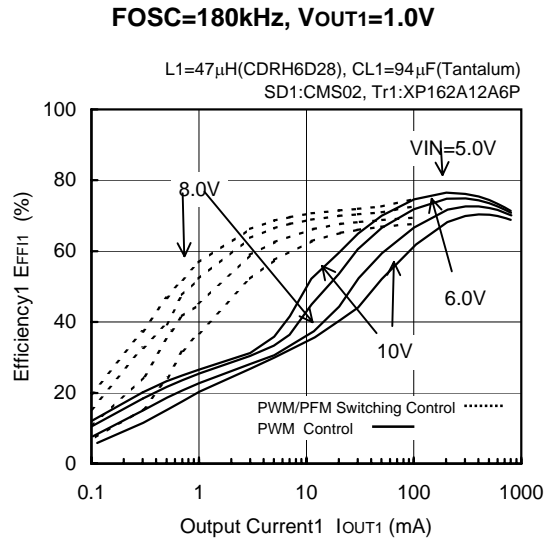
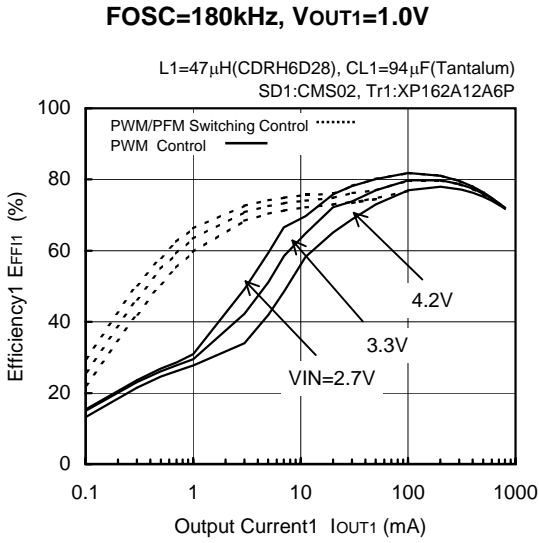

* When setting VOUT1=1.0V, VIN=8.0V or 10.0V,
CL=94 μ F (Tantalum) + 100 μ F (OS Capacitor)

< 1ch Step-Down DC/DC Controller >

(2) Efficiency vs. Output Current (Continued)

FOSC=300kHz, VOUT1=1.8V

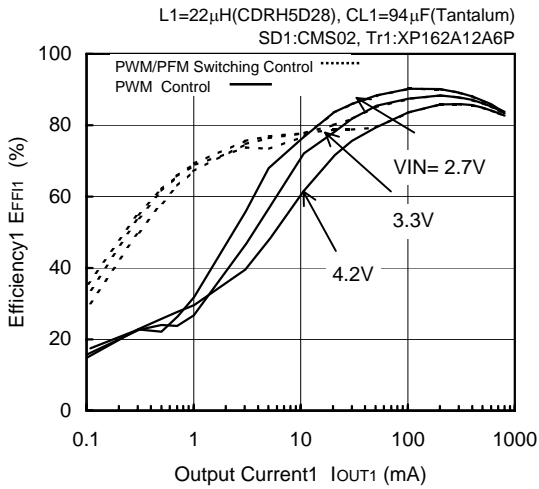

FOSC=300kHz, VOUT1=1.8V

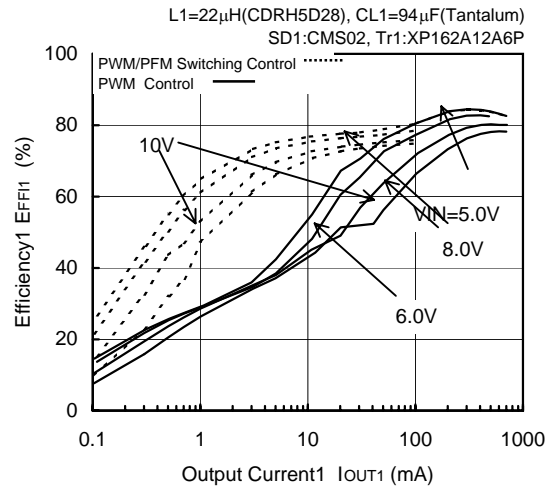

FOSC=300kHz, VOUT1=2.5V

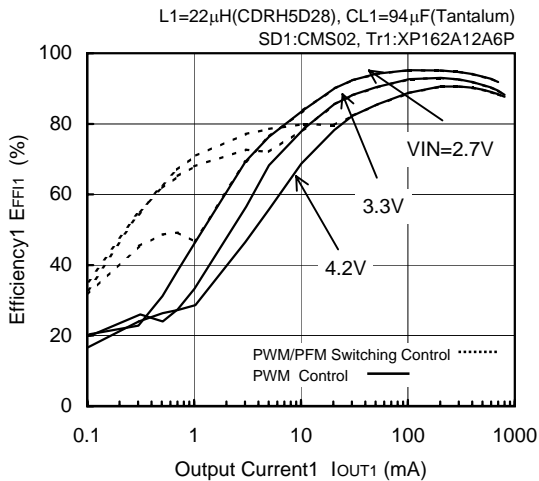

FOSC=300kHz, VOUT1=2.5V

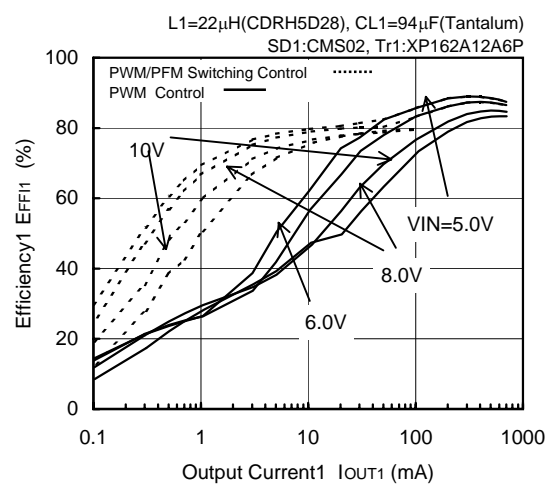

FOSC=300kHz, VOUT1=3.3V

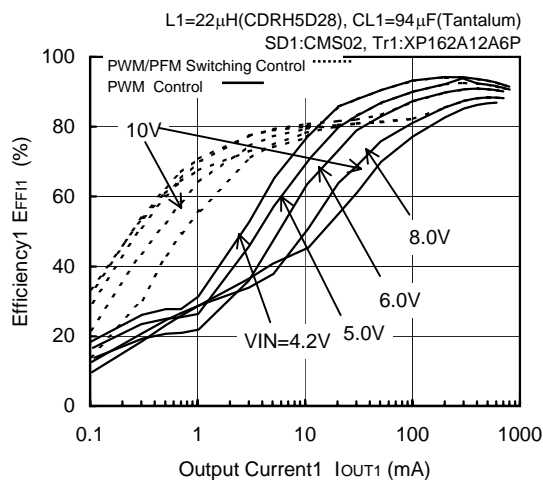

FOSC=300kHz, VOUT1=5.0V

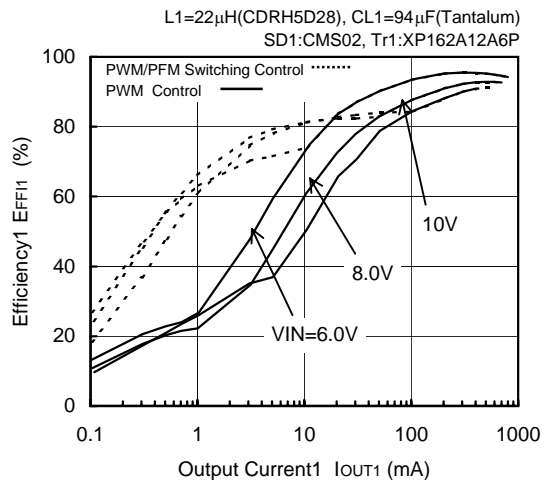

* When setting VOUT1=1.0V, VIN=8.0V or 10.0V,
CL=94 μ F (Tantalum) + 100 μ F (OS Capacitor)

< 1ch Step-Down DC/DC Controller >

(2) Efficiency vs. Output Current (Continued)

FOSC=500kHz, VOUT1=1.0V

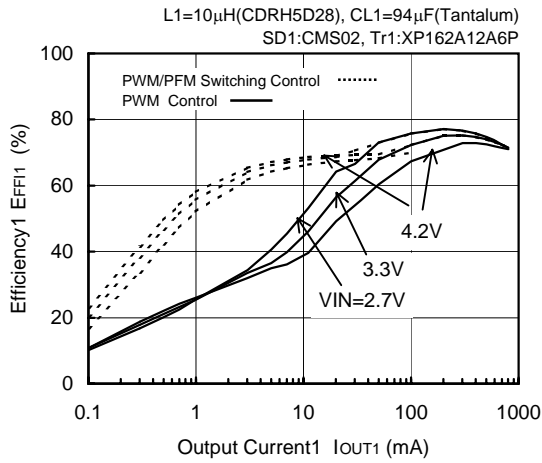

FOSC=500kHz, VOUT1=1.0V

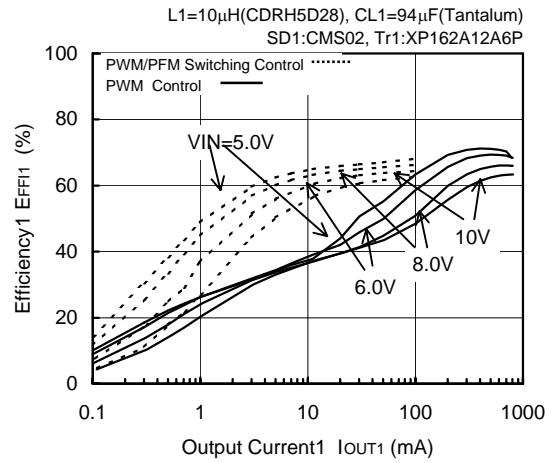

FOSC=500kHz, VOUT1=3.3V

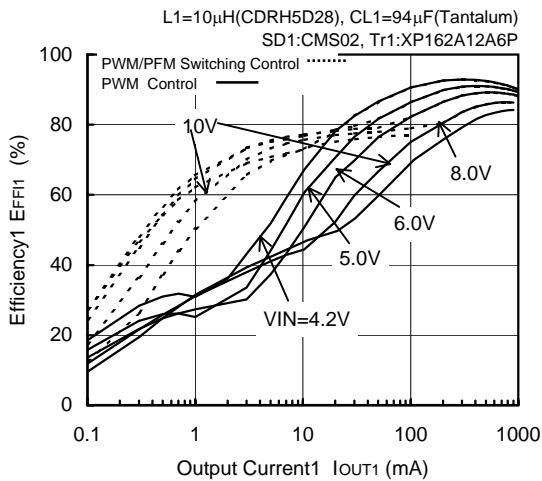

FOSC=500kHz, VOUT1=3.3V

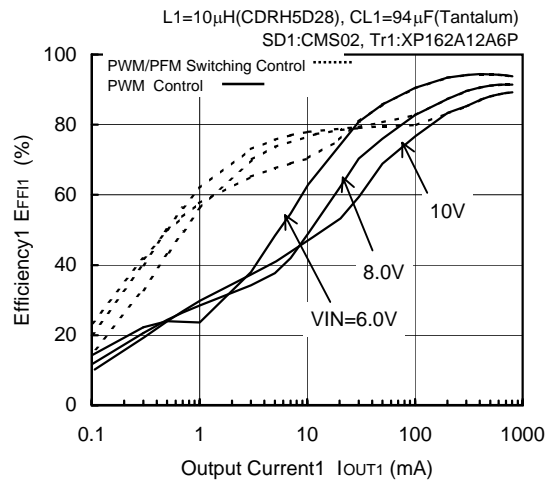

* When setting VOUT1=1.0V, VIN=8.0V or 10.0V,
CL=94 μ F (Tantalum) + 100 μ F (OS Capacitor)

< 1ch Step-Down DC/DC Controller >

(3) Ripple Voltage vs. Output Current

FOSC=180kHz, VOUT1=1.0V

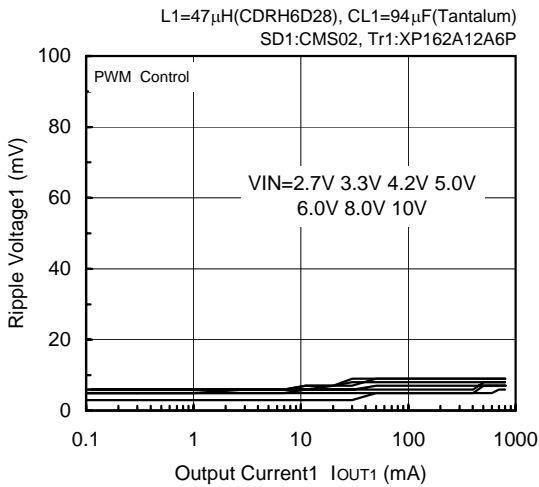

FOSC=180kHz, VOUT1=1.0V

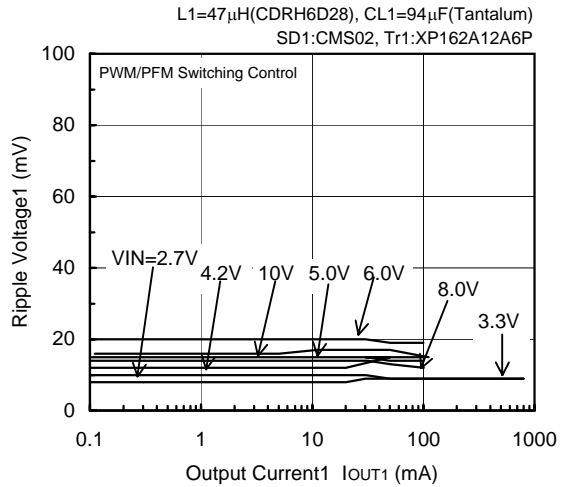

FOSC=180kHz, VOUT1=3.3V

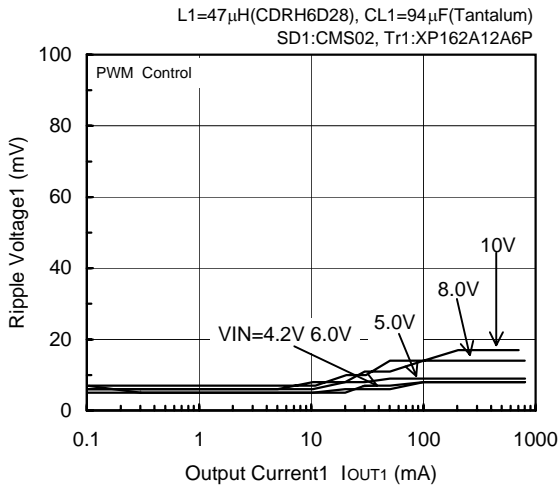

FOSC=180kHz, VOUT1=3.3V

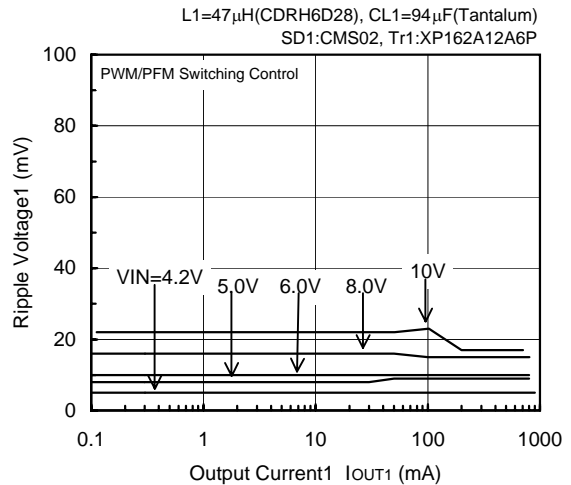

FOSC=180kHz, VOUT1=5.0V

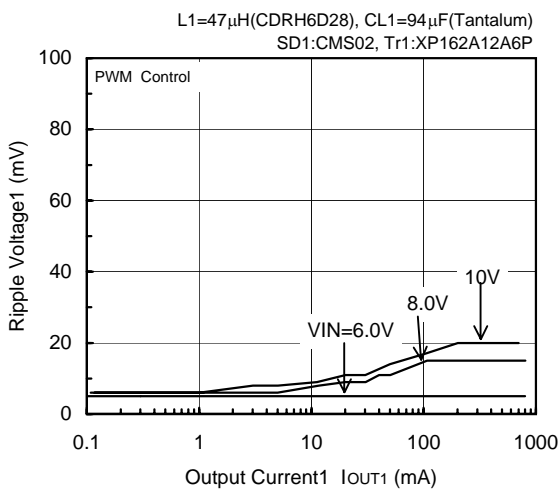

FOSC=180kHz, VOUT1=5.0V

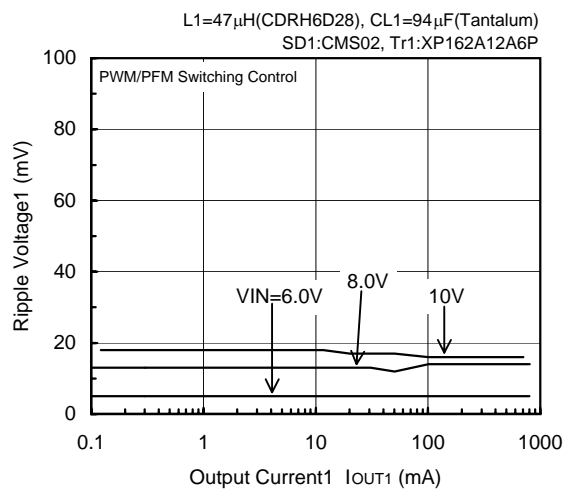

* When setting VOUT1=1.0V, VIN=8.0V or 10.0V,
CL=94 μ F (Tantalum) + 100 μ F (OS Capacitor)

< 1ch Step-Down DC/DC Controller > (3) Ripple Voltage vs. Output Current (Continued)

FOSC=300kHz, VOUT1=1.0V

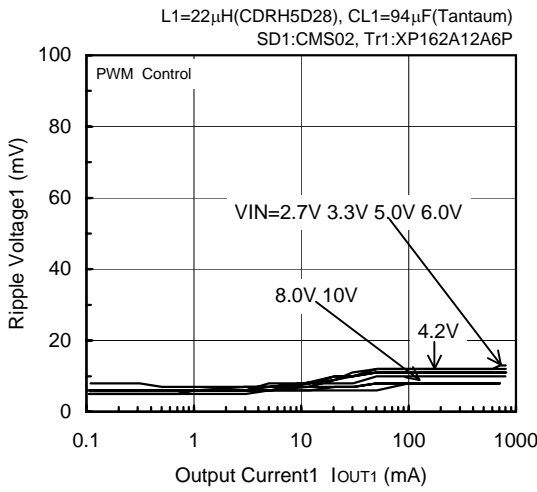

FOSC=300kHz, VOUT1=1.0V

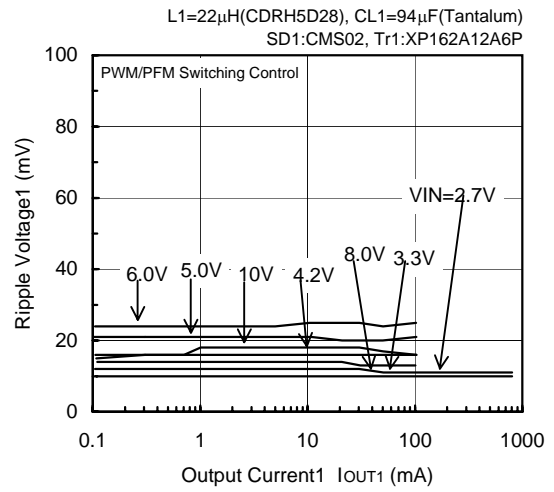

FOSC=300kHz, VOUT1=1.8V

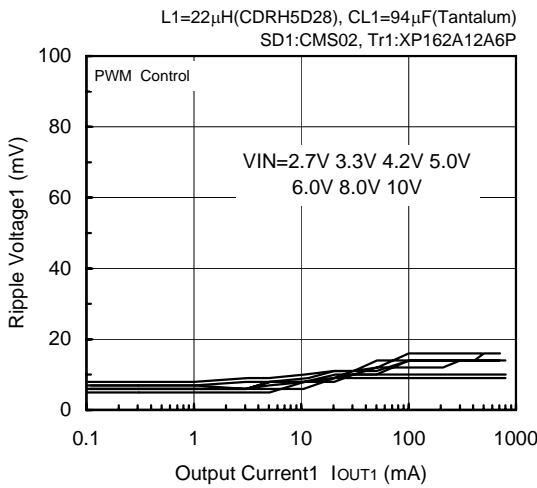

FOSC=300kHz, VOUT1=1.8V

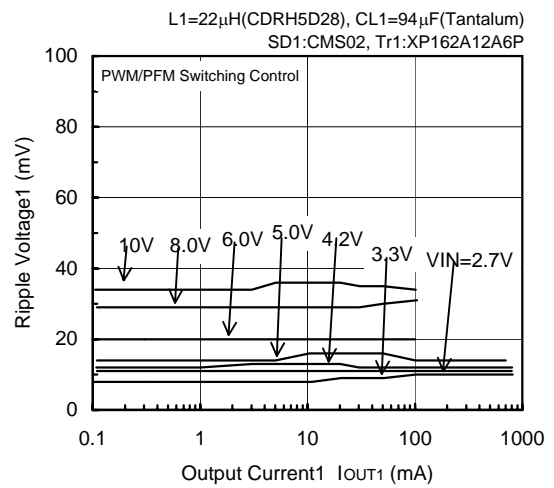

FOSC=300kHz, VOUT1=2.5V

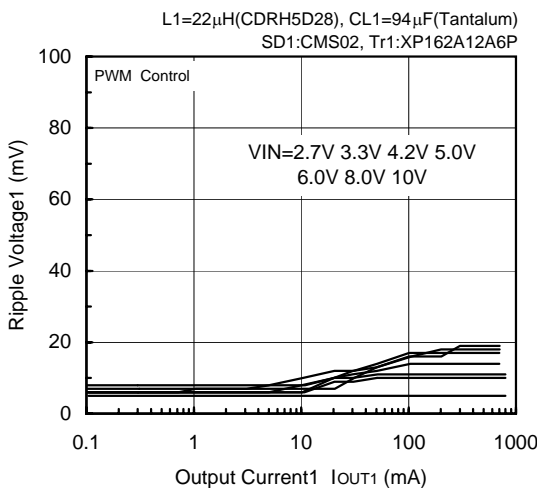

FOSC=300kHz, VOUT1=2.5V

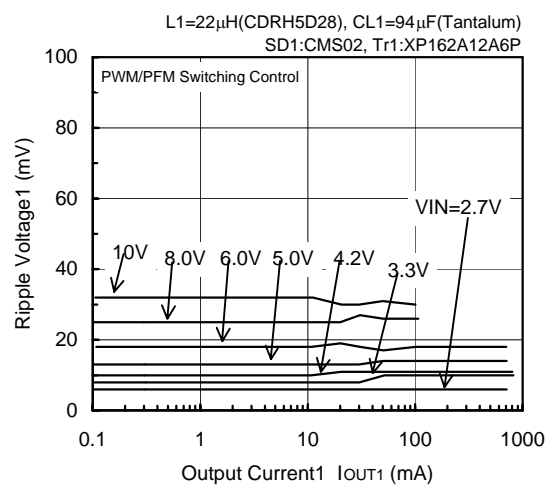

* When setting VOUT1=1.0V, VIN=8.0V or 10.0V,
CL=94 μ F (Tantalum) + 100 μ F (OS Capacitor)

< 1ch Step-Down DC/DC Controller >

(3) Ripple Voltage vs. Output Current (Continued)

FOSC=300kHz, VOUT1=3.3V

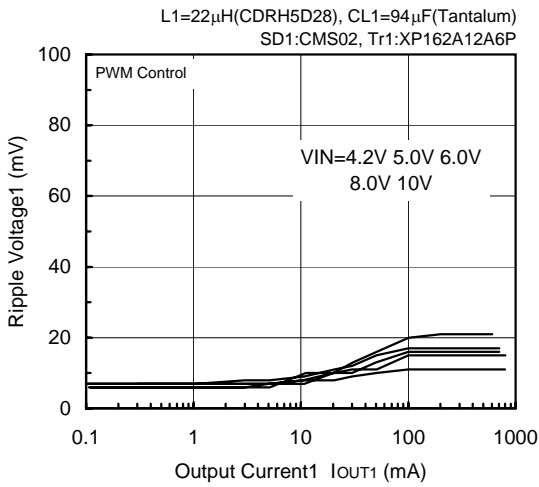

FOSC=300kHz, VOUT1=3.3V

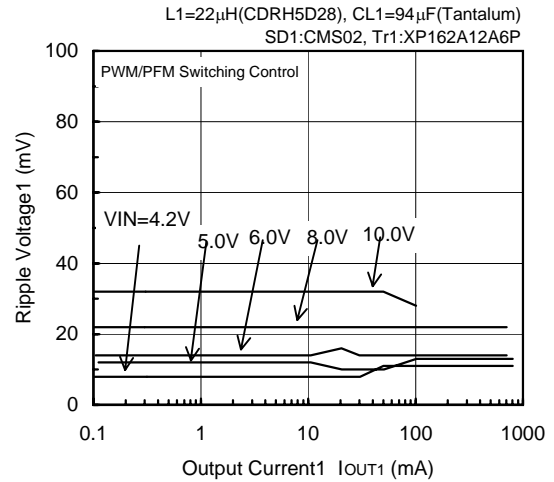

FOSC=300kHz, VOUT1=5.0V

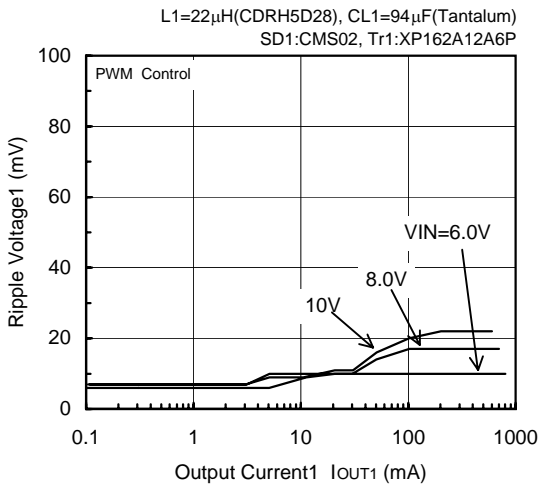

FOSC=300kHz, VOUT1=5.0V

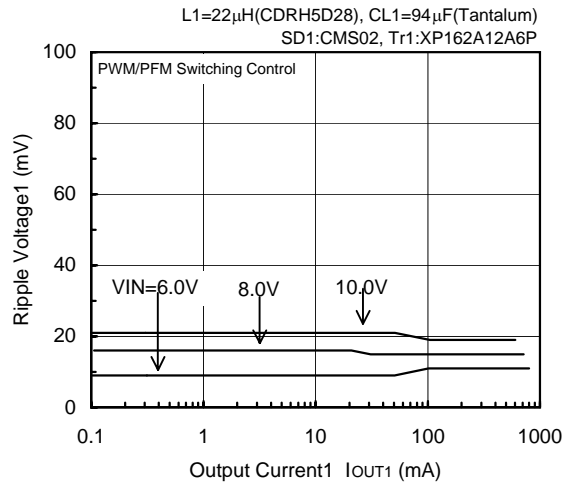

FOSC=500kHz, VOUT1=1.0V

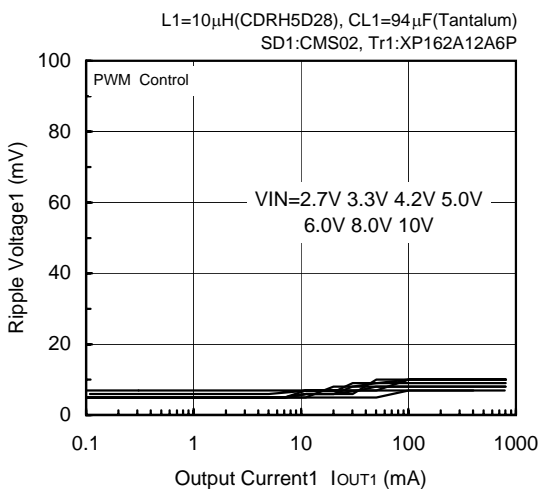

FOSC=500kHz, VOUT1=1.0V

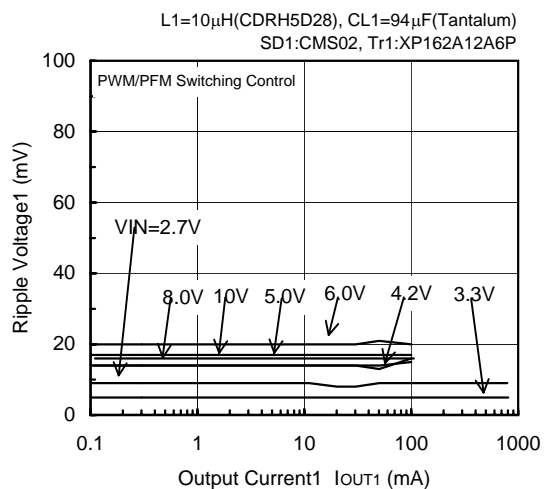

* When setting VOUT1=1.0V, VIN=8.0V or 10.0V,
CL=94 μ F (Tantalum) + 100 μ F (OS Capacitor)

< 1ch Step-Down DC/DC Controller >

(3) Ripple Voltage vs. Output Current (Continued)

FOSC=500kHz, VOUT1=3.3V

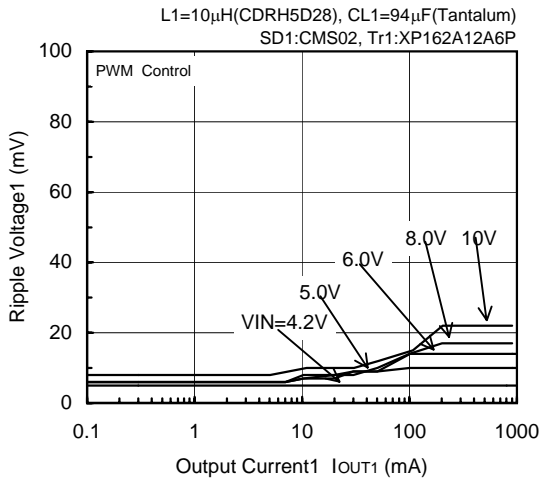

FOSC=500kHz, VOUT1=3.3V

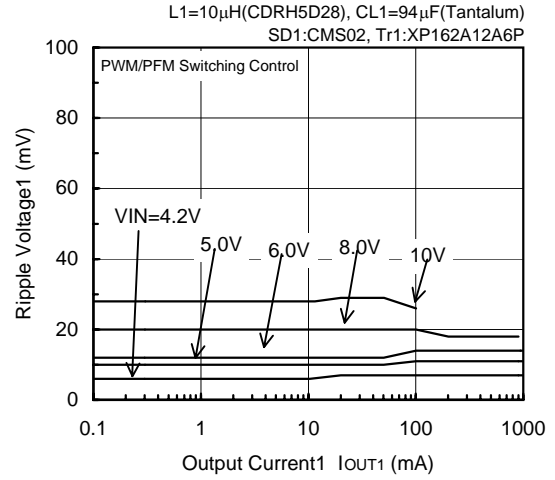

FOSC=500kHz, VOUT1=5.0V

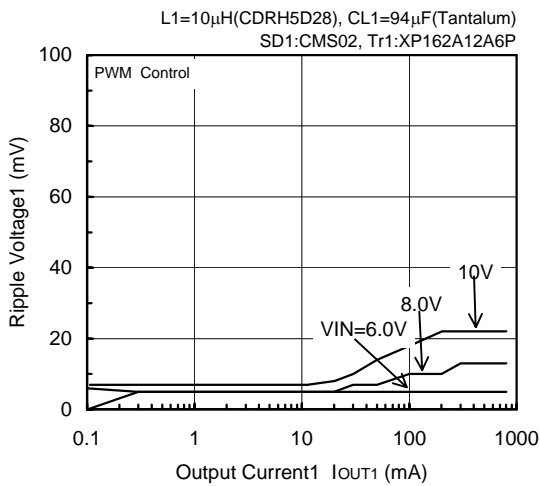

FOSC=500kHz, VOUT1=5.0V

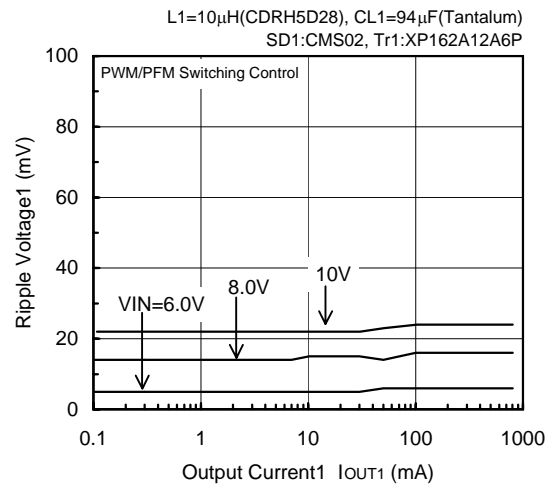

* When setting VOUT1=1.0V, VIN=8.0V or 10.0V,
CL=94 μ F (Tantalum) + 100 μ F (OS Capacitor)

■ **Typical Performance Characteristics**

< **2ch. Inverting DC/DC Controller** >

(4) Output Voltage vs. Output Current

<Ceramic Capacitor and Compact Inductor use>

FOSC=180kHz, VOUT2= -7.5V

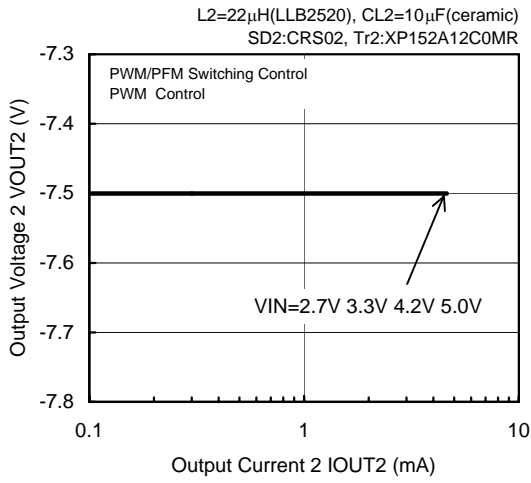

FOSC=180kHz, VOUT2= -10.0V

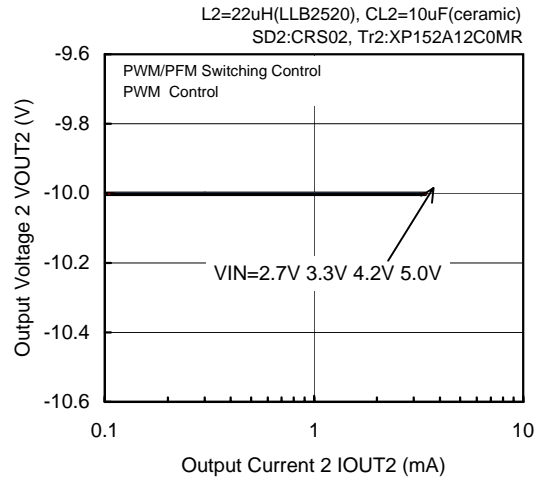

FOSC=300kHz, VOUT2= -7.5V

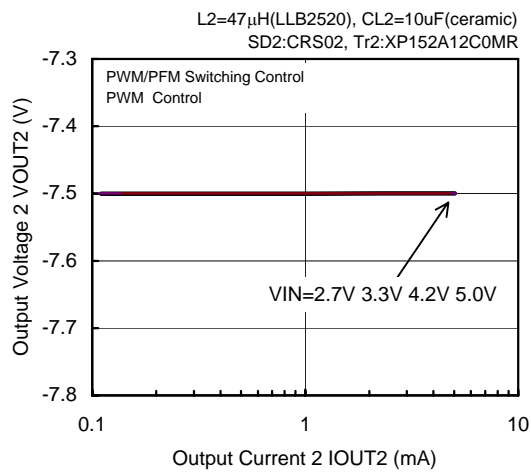

< 2ch. Inverting DC/DC Controller >

(4) Output Voltage vs. Output Current

<Ceramic Capacitor use>

FOSC=180kHz, VOUT2= -7.5V

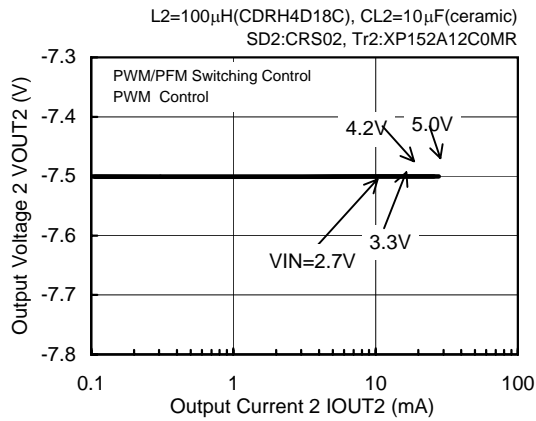

FOSC=180kHz, VOUT2= -10.0V

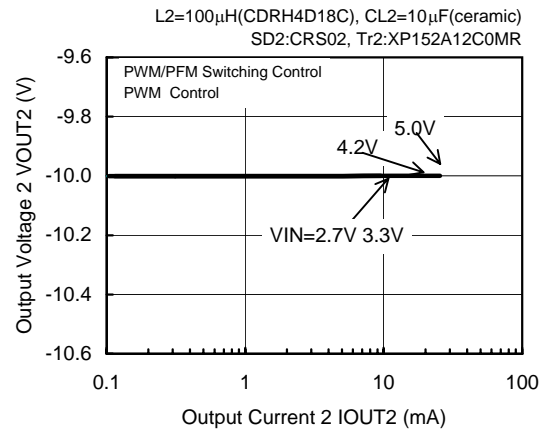

FOSC=180kHz, VOUT2= -7.5V

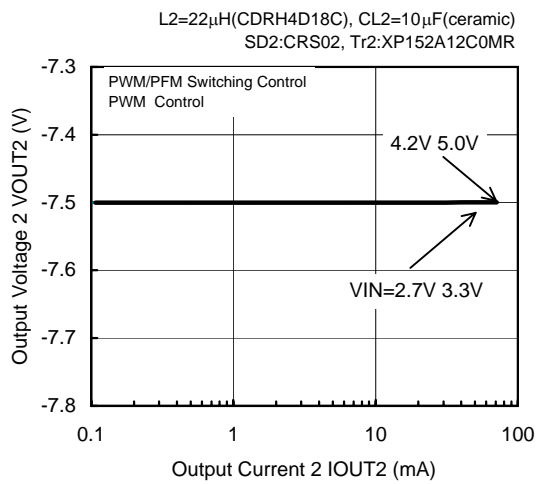

FOSC=180kHz, VOUT2= -10.0V

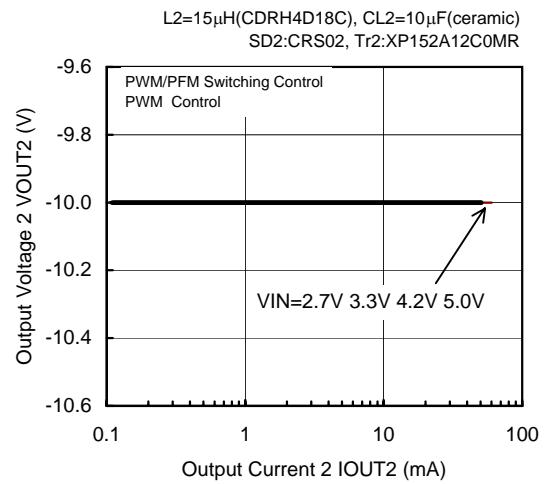

< 2ch. Inverting DC/DC Controller >

(4) Output Voltage vs. Output Current

<Tantalum Capacitor use>

FOSC=180kHz, VOUT2= -7.5V

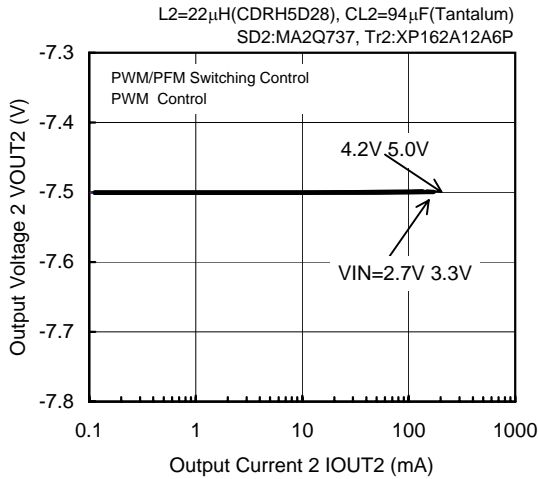

FOSC=180kHz, VOUT2= -10.0V

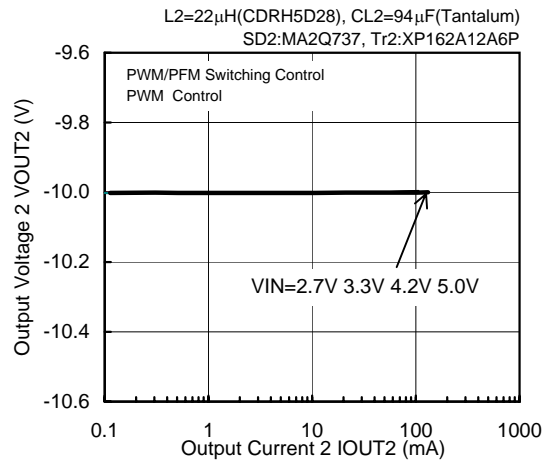

FOSC=300kHz, VOUT2= -5.0V

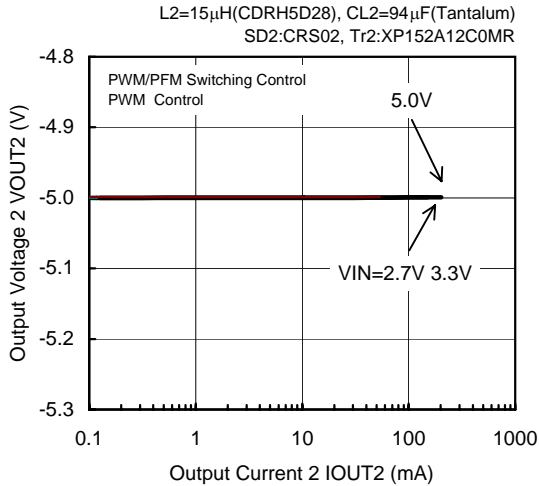

FOSC=300kHz, VOUT2= -7.5V

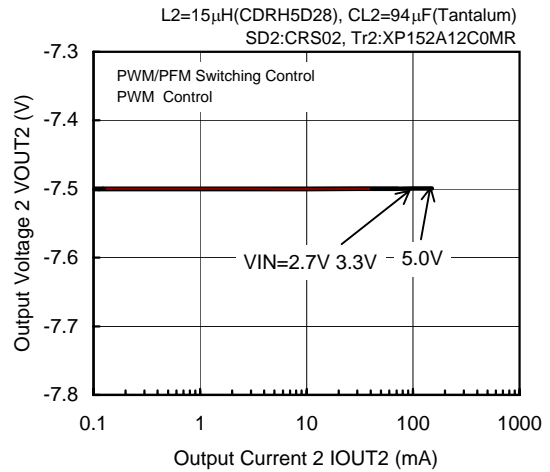

FOSC=300kHz, VOUT2= -10.0V

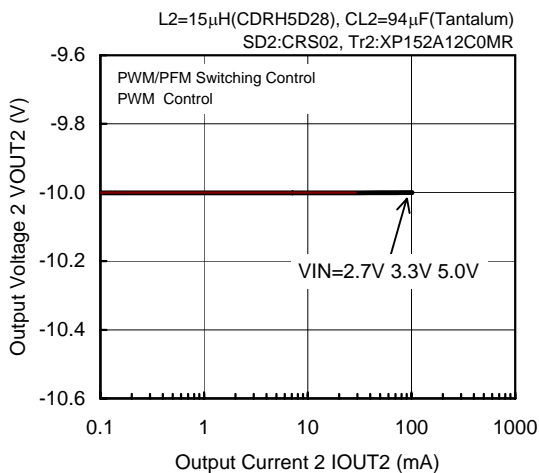

FOSC=300kHz, VOUT2= -15.0V

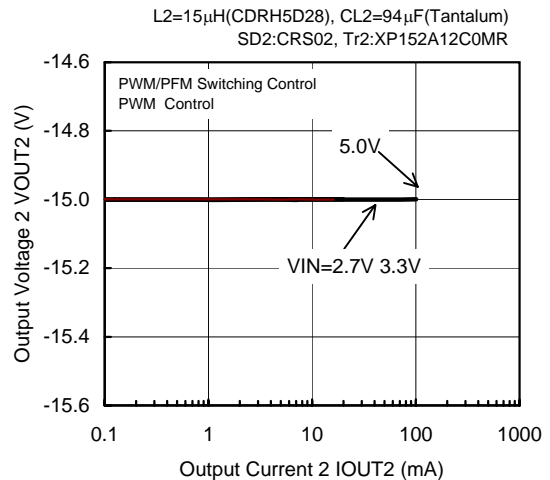

< 2ch. Inverting DC/DC Controller >

(5) Efficiency vs. Output Current

<Ceramic Capacitor and Compact Inductor use>

FOSC=180kHz, VOUT2= -7.5V

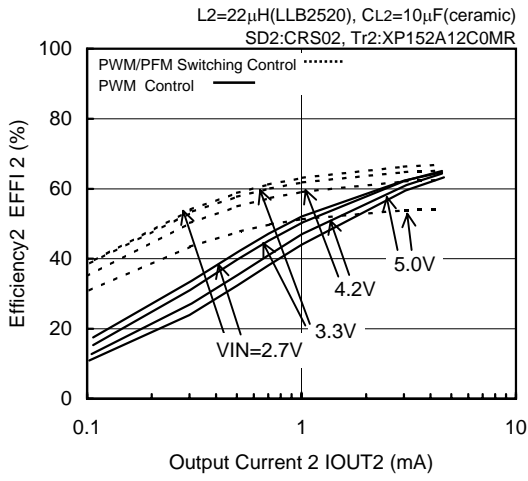

FOSC=180kHz, VOUT2= -10.0V

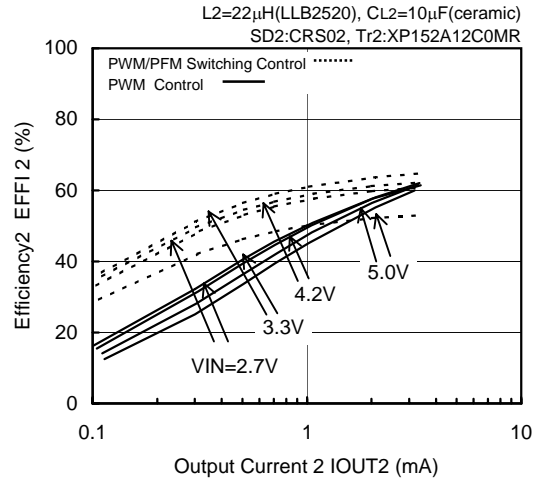

FOSC=300kHz, VOUT2= -7.5V

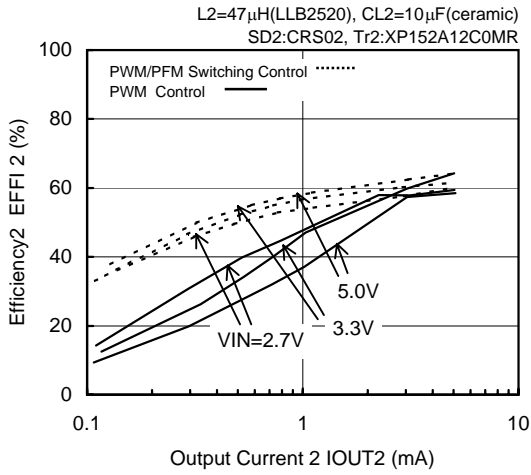

< 2ch. Inverting DC/DC Controller >

(5) Efficiency vs. Output Current (Continued)

<Ceramic Capacitor use>

FOSC=180kHz, VOUT2= -7.5V

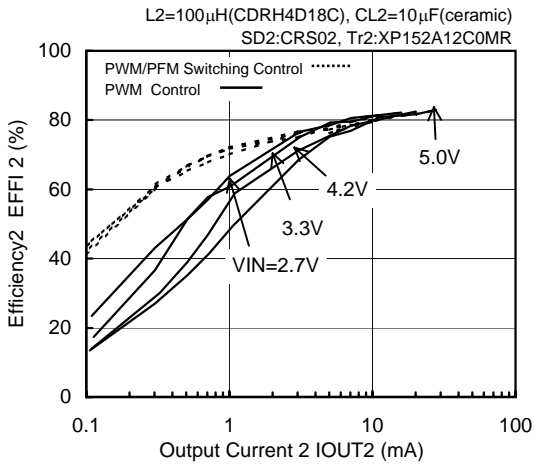

FOSC=180kHz, VOUT2= -10.0V

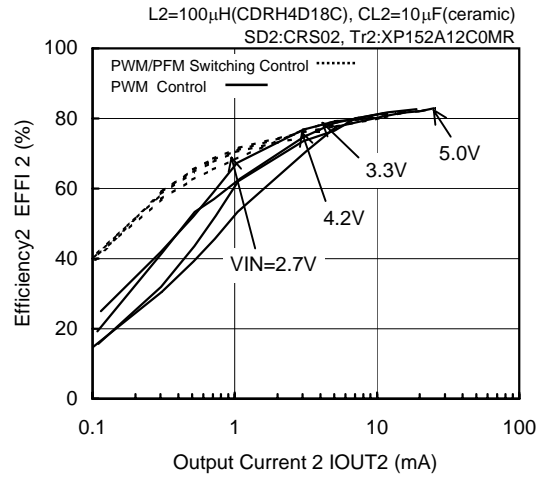

FOSC=180kHz, VOUT2= -7.5V

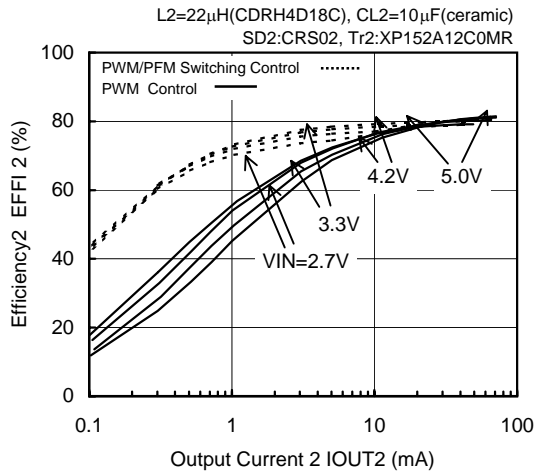

FOSC=180kHz, VOUT2= -10.0V

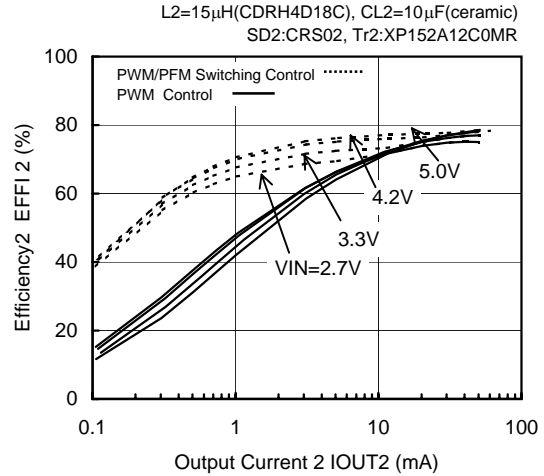

< 2ch. Inverting DC/DC Controller >

(5) Efficiency vs. Output Current (Continued)

<Tantalum Capacitor use>

FOSC=180kHz, VOUT2= -7.5V

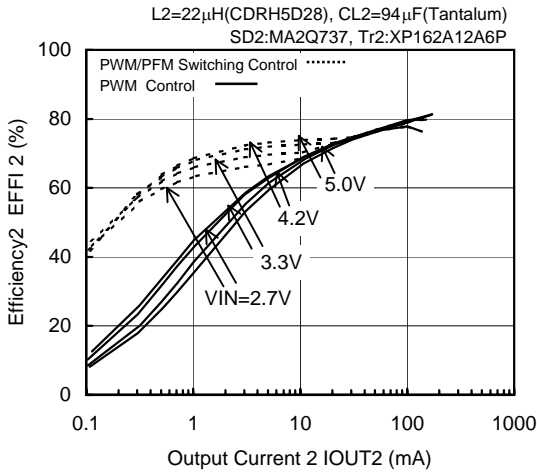

FOSC=180kHz, VOUT2= -10.0V

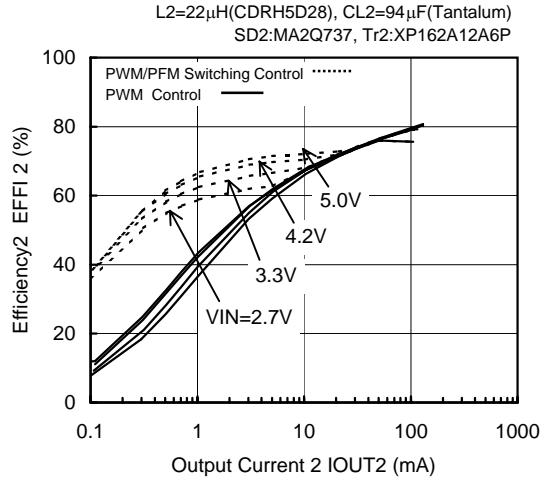

FOSC=300kHz, VOUT2= -5.0V

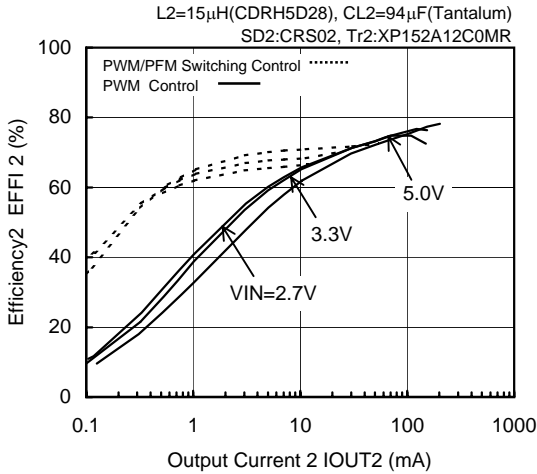

FOSC=300kHz, VOUT2= -7.5V

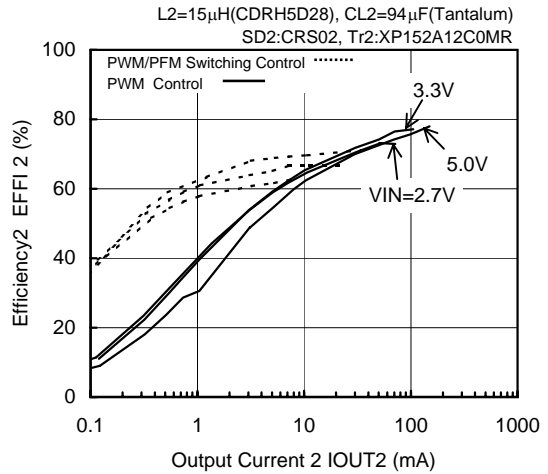

FOSC=300kHz, VOUT2= -10.0V

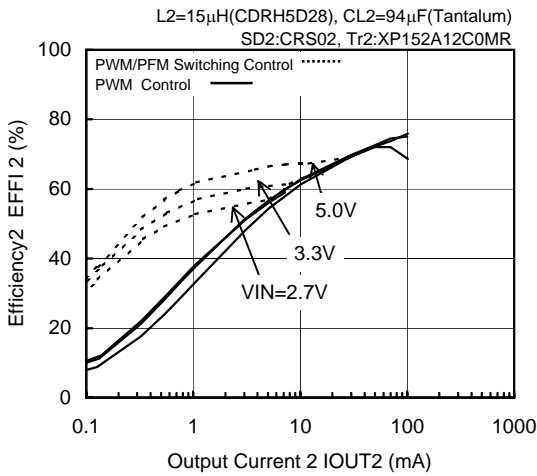

FOSC=300kHz, VOUT2= -15.0V

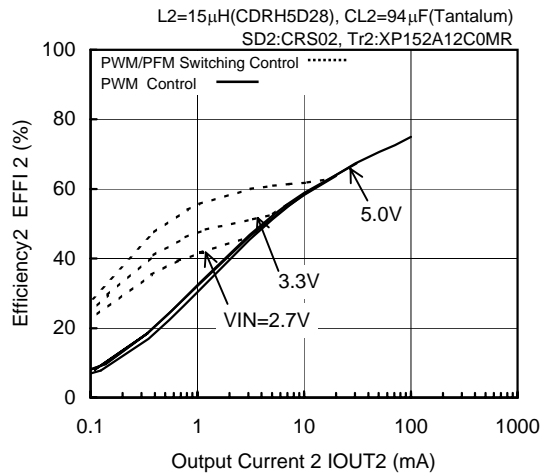

< 2ch. Inverting DC/DC Controller >

(6) Ripple Voltage vs. Output Current

<Ceramic Capacitor and Compact Inductor use>

FOSC=180kHz, VOUT2= -7.5V

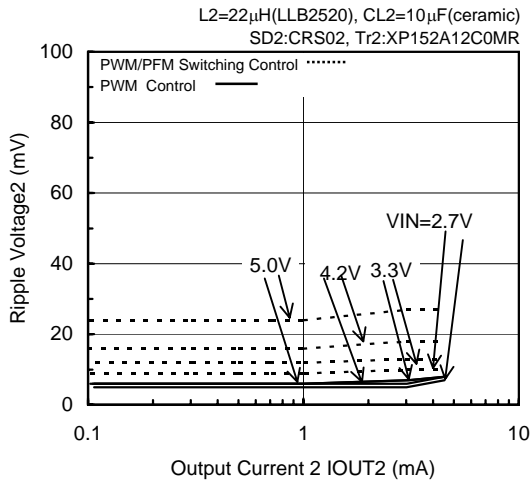

FOSC=180kHz, VOUT2= -10.0V

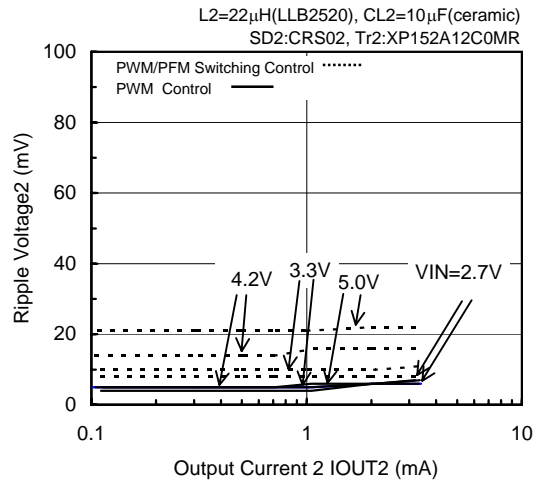

FOSC=300kHz, VOUT2= -7.5V

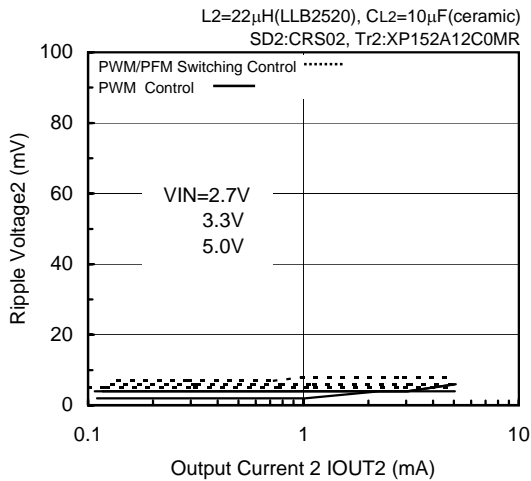

< 2ch. Inverting DC/DC Controller >

(6) Ripple Voltage vs. Output Current (Continued)

<Ceramic Capacitor use>

FOSC=180kHz, VOUT2= -7.5V

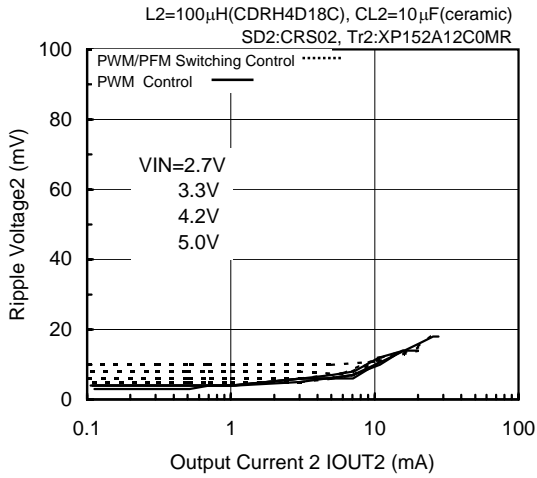

FOSC=180kHz, VOUT2= -10.0V

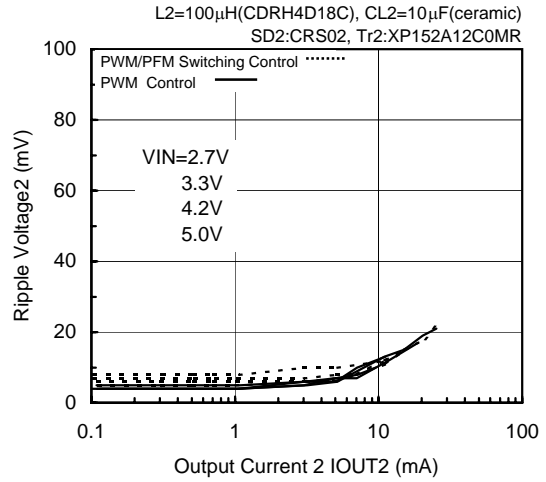

FOSC=180kHz, VOUT2= -7.5V

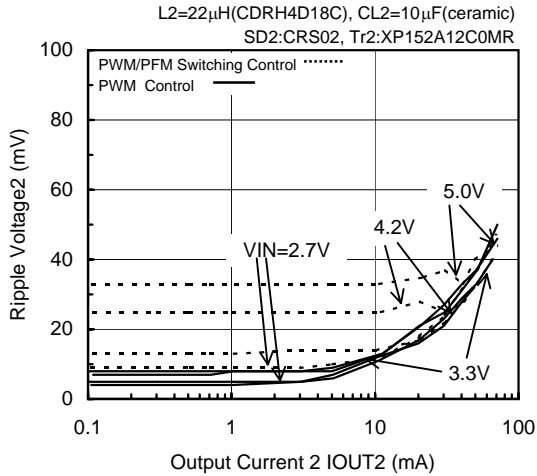

FOSC=180kHz, VOUT2= -10.0V

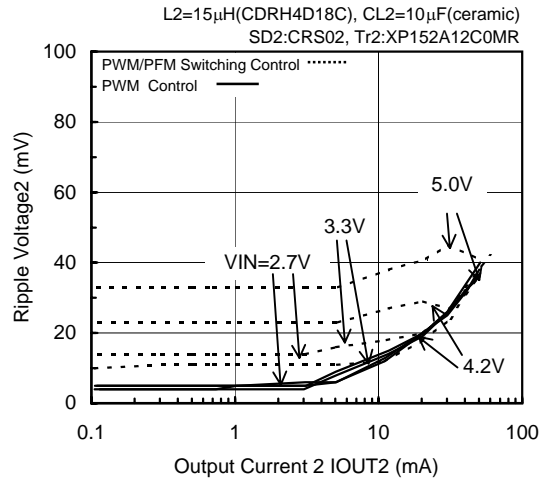

< 2ch. Inverting DC/DC Controller >

(6) Ripple Voltage vs. Output Current (Continued)

<Tantalum Capacitor use>

FOSC=180kHz, VOUT2= -7.5V

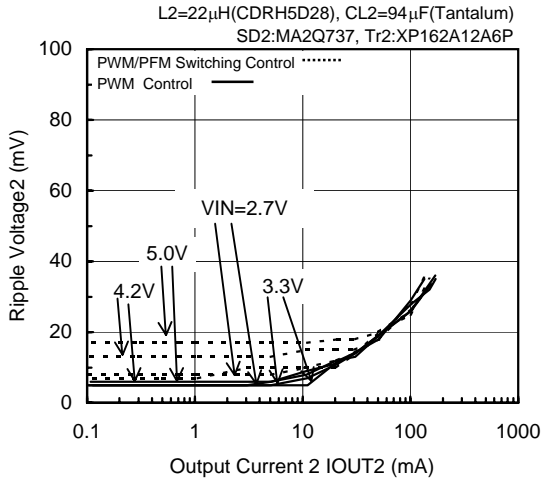

FOSC=180kHz, VOUT2= -10.0V

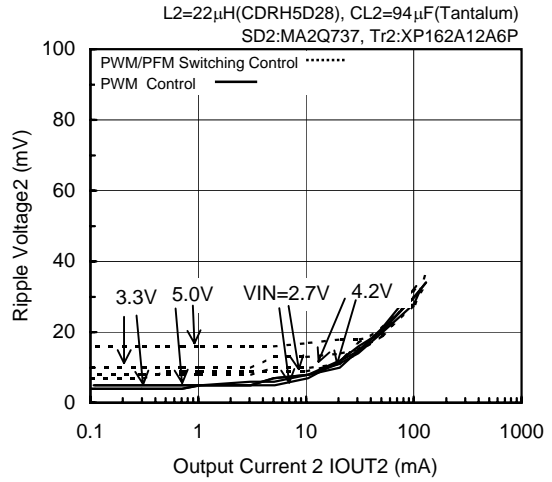

FOSC=300kHz, VOUT2= -5.0V

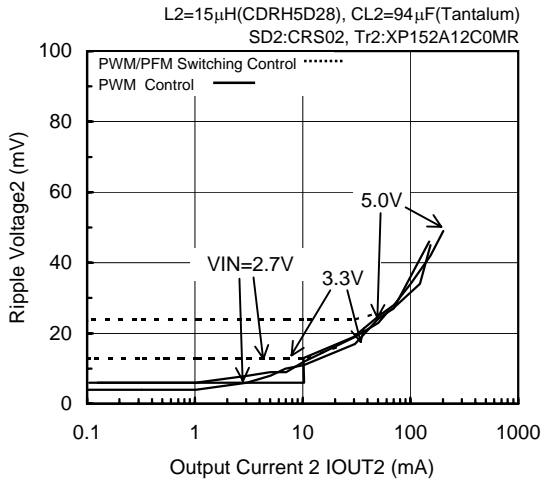

FOSC=300kHz, VOUT2= -7.5V

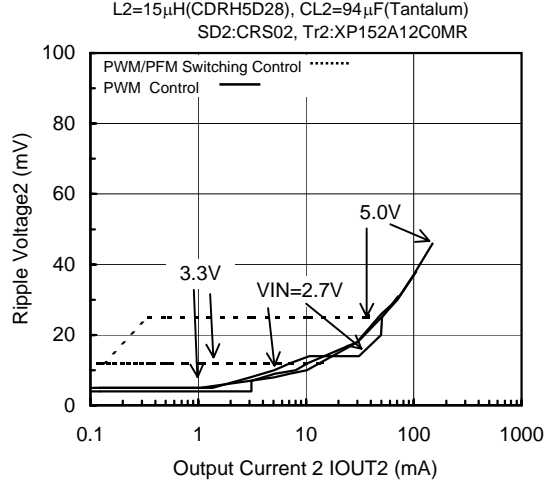

FOSC=300kHz, VOUT2= -10.0V

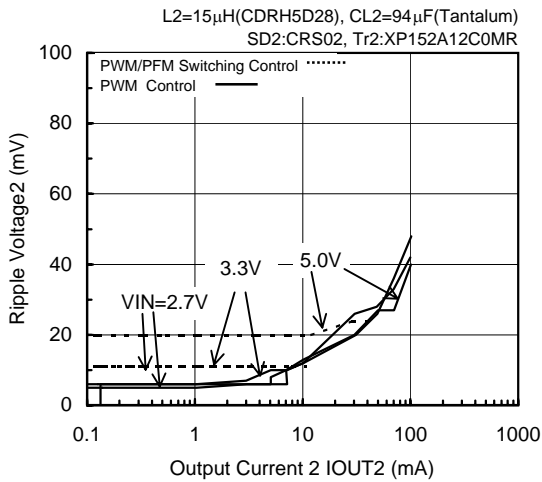

FOSC=180kHz, VOUT2= -15.0V

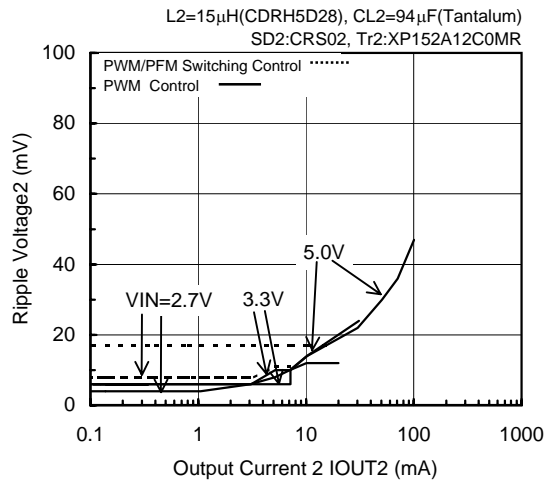

< 2ch. Inverting DC/DC Controller >

(7) Breakdown of Output Voltage

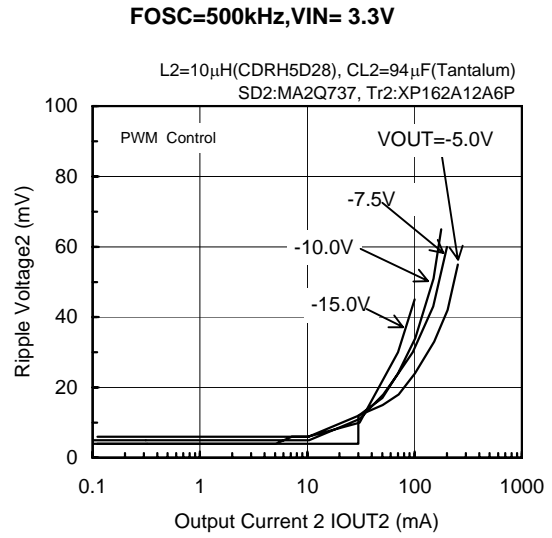
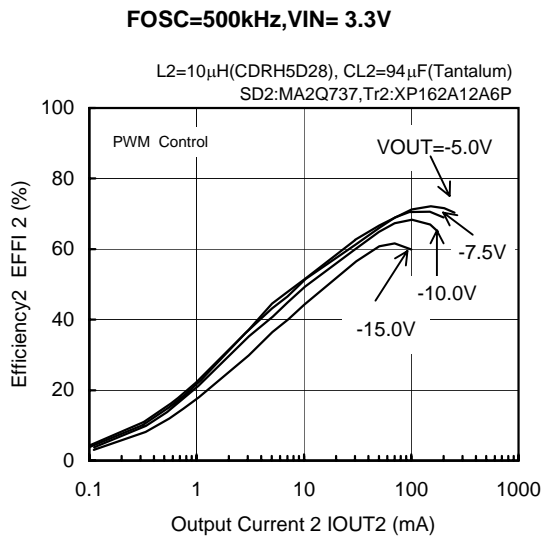
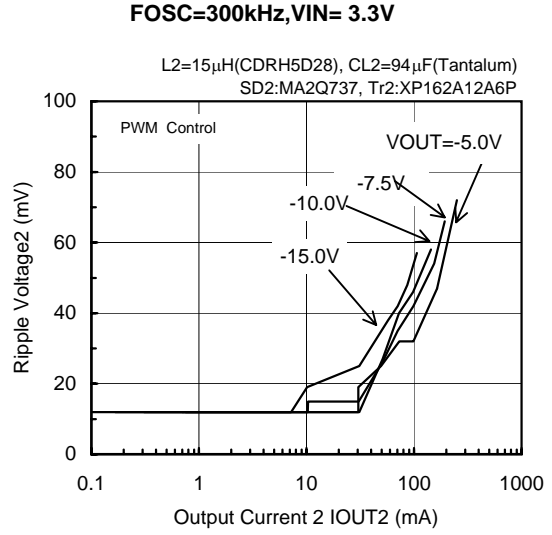
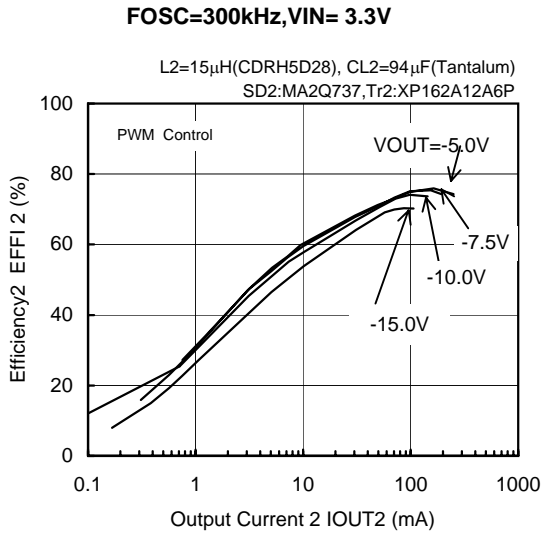
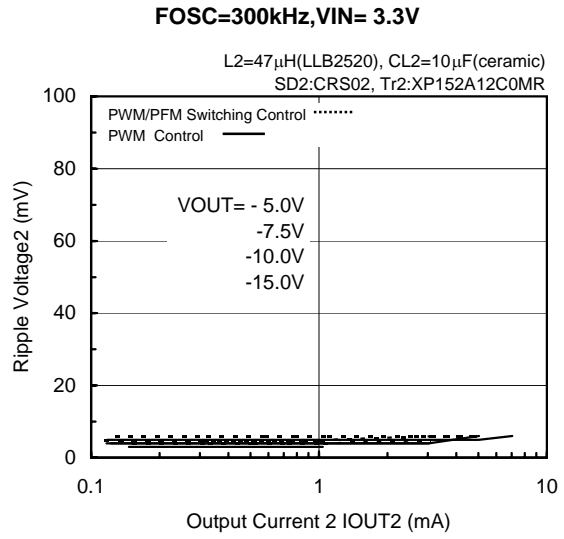
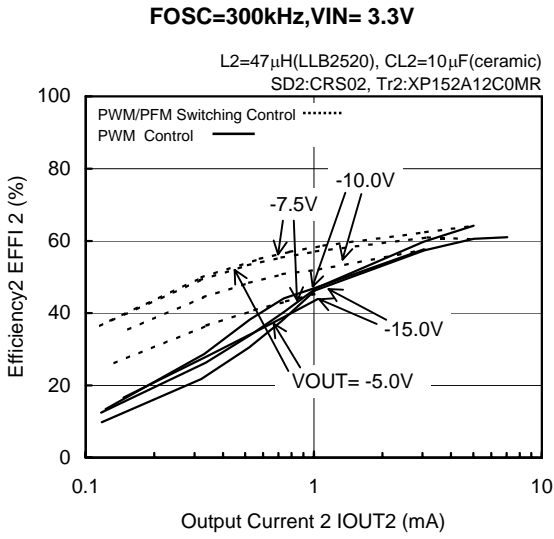

< 2ch. Inverting DC/DC Controller >
 (8) Breakdown of Coil Inductance Value

FOSC=300kHz, VIN=3.3V, Output2= -7.5V

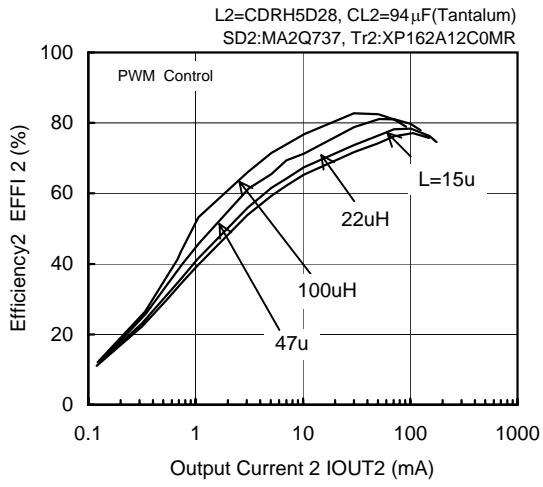

FOSC=300kHz, VIN=3.3V, Output2= -7.5V

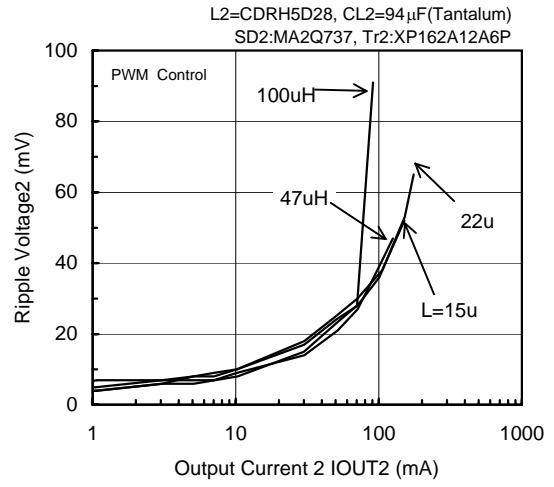

■ Typical Performacen Characteristics (Continued)

(9) Supply Current 1 vs. Supply Voltage

XC9505B092 (180KHz)

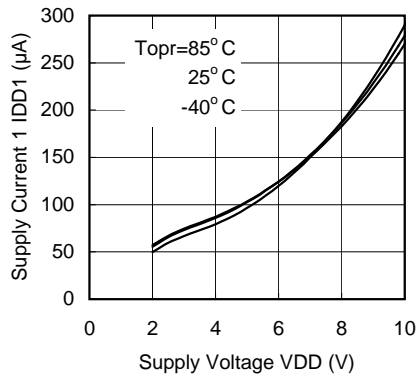

(10) Supply Current 1-1 vs. Supply Voltage

XC9505B092 (180KHz)

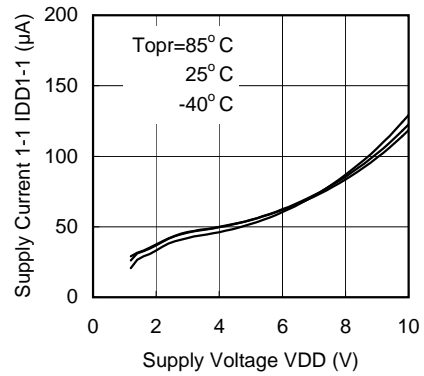

(11) Supply Current 1-2 vs. Supply Voltage

XC9505B092 (180KHz)

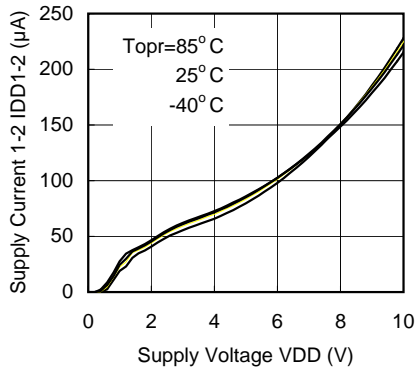

(12) Supply Current 1-3 vs. Supply Voltage

XC9505B095 (180KHz)

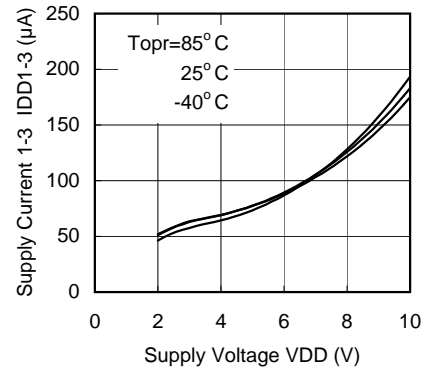

(13) Supply Current 1-4 vs. Supply Voltage

XC9505B092 (180KHz)

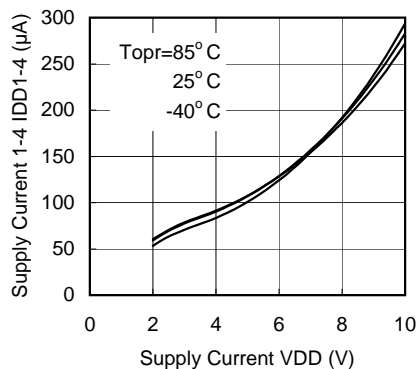

(14) Supply Current 2 vs. Supply Voltage

XC9505B092 (180KHz)

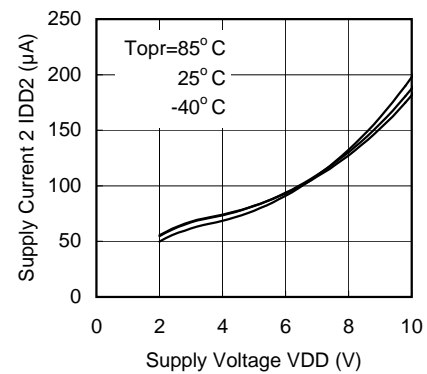

(15) Stand-by Current vs. Supply Voltage

XC9505B092 (180kHz)

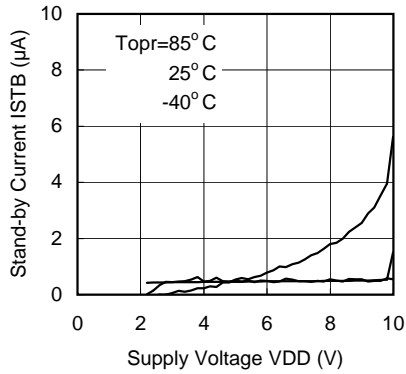

(16) Oscillation Frequency vs. Supply Voltage

XC9505B092 (180kHz)

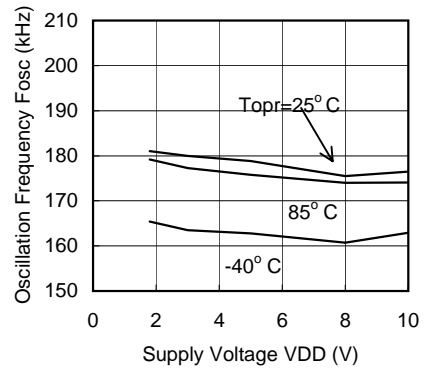

(17) PWM1, 2 'H' 'L' Voltage vs. Supply Voltage

XC9505B092 (180kHz)

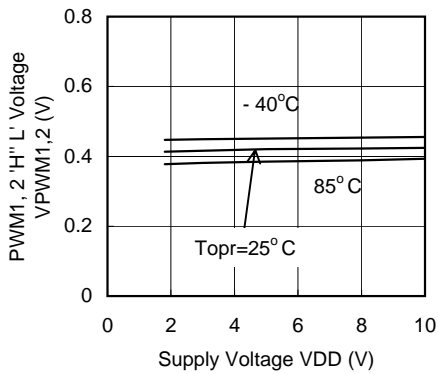

(18) EN1, 2 'H' 'L' Voltage vs. Supply Voltage

XC9505B092 (180kHz)

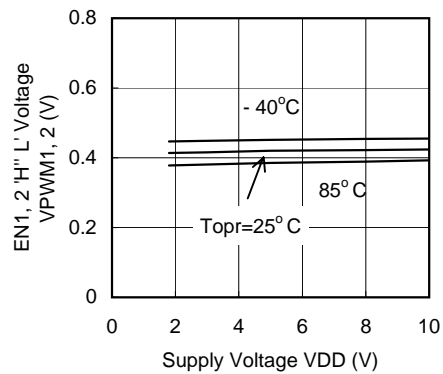

(19) Maximum Duty Ratio 2 vs. Supply Voltage

XC9505B092 (180kHz)

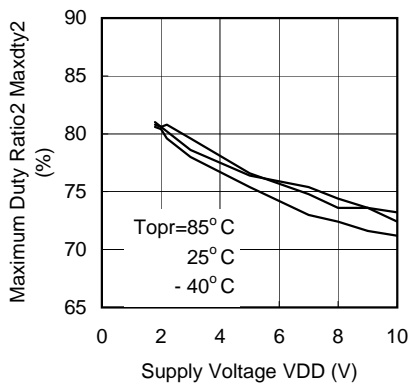

(20) Soft-start Time vs. Supply Voltage

XC9505B092 (180kHz)

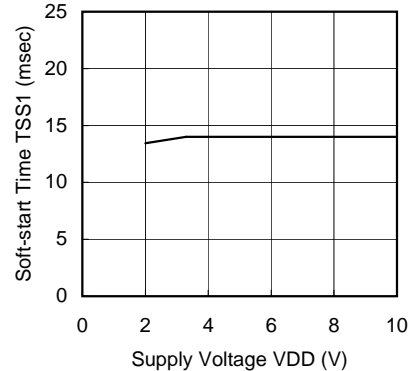

(21) EXT1, 2 High ON Resistance vs. Supply Voltage

XC9505B092 (180kHz)

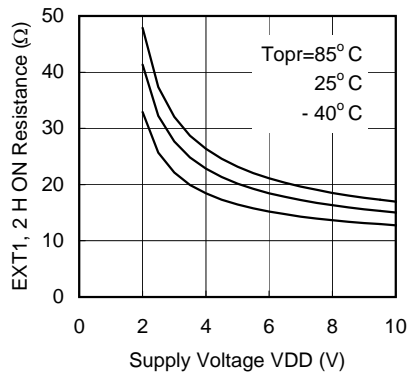

(22) EXT1, 2 Low ON Resistance vs. Supply Voltage

XC9505B092 (180kHz)

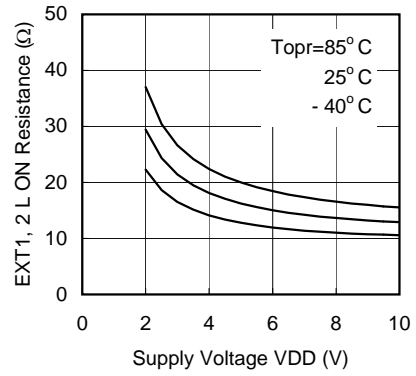

(23) Output Voltage vs. Ambient Temperature

XC9505B093(300kHz)

L=22uH(CDRH5D28), CL=94uF(Tantalum)
Tr:XP162A12A6, SD:CMS02

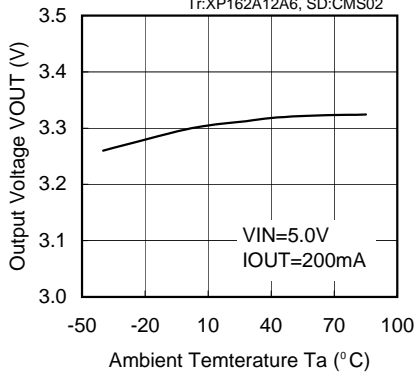

(24) PFM Duty Ratio1, 2 vs. Supply Voltage

XC9505B092(180kHz)

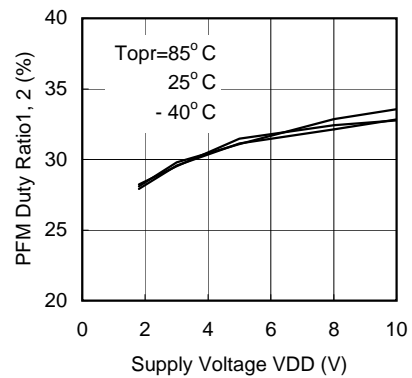

■ Load Transient Response

< 1 ch. Step-Up DC/DC Controller >

< $V_{OUT1} = 3.3V$, $V_{IN} = 5.0V$ $I_{OUT1} = 100\mu A \leftrightarrow 300mA$ >

○ PWM Control

FOSC=300kHz, $V_{OUT1}=3.3V$
 $V_{IN}=5.0V$, $I_{OUT1}=100\mu A \rightarrow 300mA$

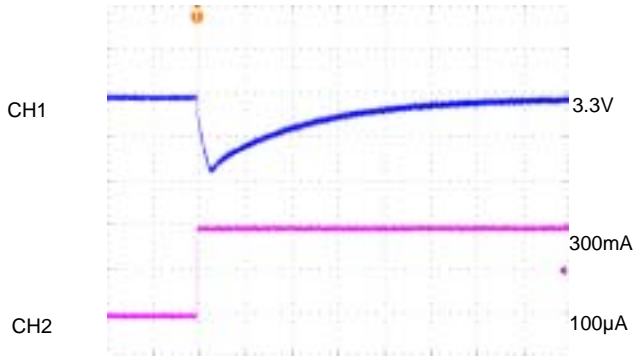

200µsec/div
 CH1: V_{out1} , AC-COUPLED, 100mV/div
 CH2: I_{out1} , 150mA/div

FOSC=300kHz, $V_{OUT1}=3.3V$
 $V_{IN}=5.0V$, $I_{OUT1}=300mA \rightarrow 100\mu A$

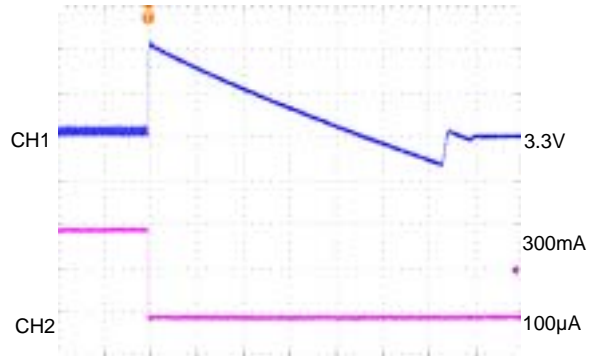

10msec/div
 CH1: V_{out1} , AC-COUPLED, 50mV/div
 CH2: I_{out1} , 150mA/div

○ PWM/PFM Switching Control

FOSC=300kHz, $V_{OUT1}=3.3V$
 $V_{IN}=5.0V$, $I_{OUT1}=100\mu A \rightarrow 300mA$

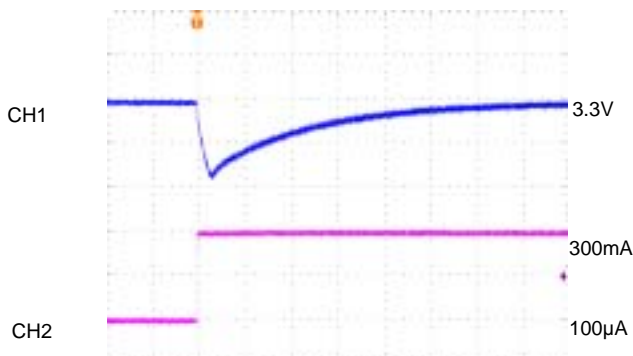

200µsec/div
 CH1: V_{out1} , AC-COUPLED, 100mV/div
 CH2: I_{out1} , 150mA/div

FOSC=300kHz, $V_{OUT1}=3.3V$
 $V_{IN}=5.0V$, $I_{OUT1}=300mA \rightarrow 100\mu A$

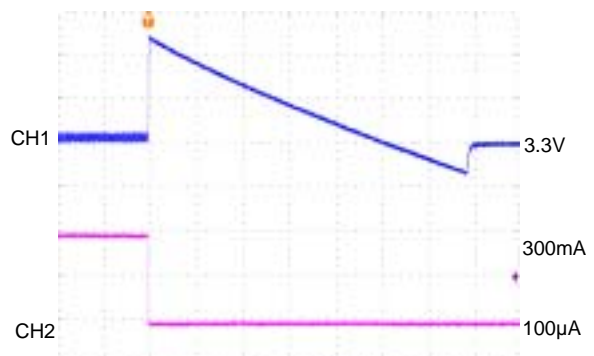

10msec/div
 CH1: V_{out1} , AC-COUPLED, 100mV/div
 CH2: I_{out1} , 150mA/div

< 1 ch. Step-Up DC/DC Controller >

< $V_{OUT1} = 3.3V$, $V_{IN} = 5.0V$ $I_{OUT1} = 10mA \leftrightarrow 300mA$ >

○ PWM Control

FOSC=300kHz, $V_{OUT1}=3.3V$
 $V_{IN}=5.0V$, $I_{OUT1}=10mA \rightarrow 300mA$

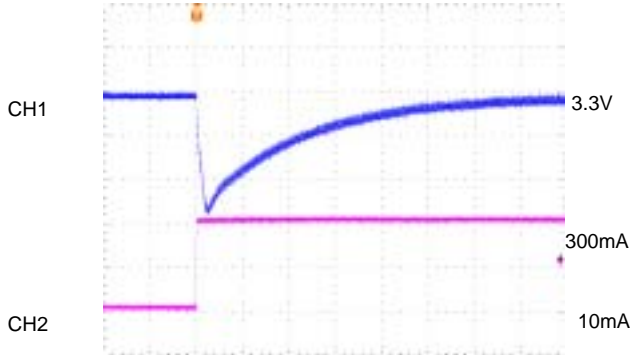

200µsec/div
 CH1: V_{OUT1} , AC-COUPLED, 50mV/div
 CH2: I_{OUT1} , 150mA/div

FOSC=300kHz, $V_{OUT1}=3.3V$
 $V_{IN}=5.0V$, $I_{OUT1}=300mA \rightarrow 10mA$

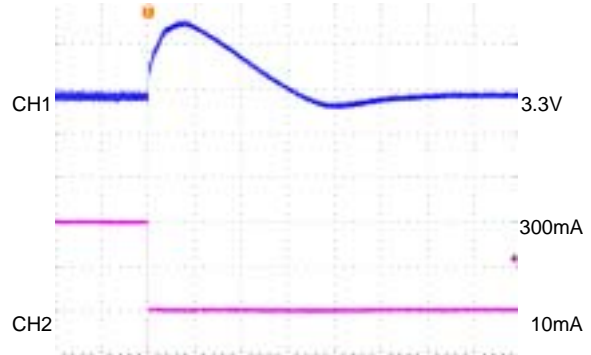

400µsec/div
 CH1: V_{OUT1} , AC-COUPLED, 50mV/div
 CH2: I_{OUT1} , 150mA/div

○ PWM/PFM Switching Control

FOSC=300kHz, $V_{OUT1}=3.3V$
 $V_{IN}=5.0V$, $I_{OUT1}=10mA \rightarrow 300mA$

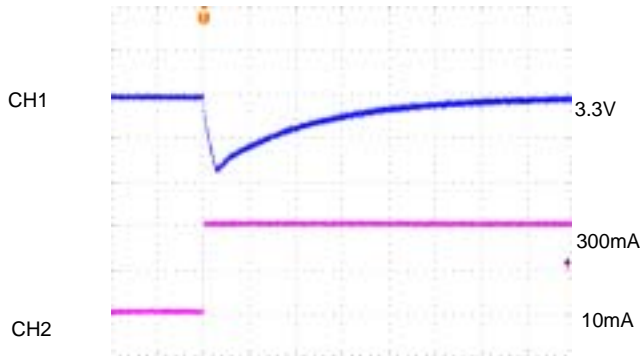

200µsec/div
 CH1: V_{OUT1} , AC-COUPLED, 100mV/div
 CH2: I_{OUT1} , 150mA/div

FOSC=300kHz, $V_{OUT1}=3.3V$
 $V_{IN}=5.0V$, $I_{OUT1}=300mA \rightarrow 10mA$

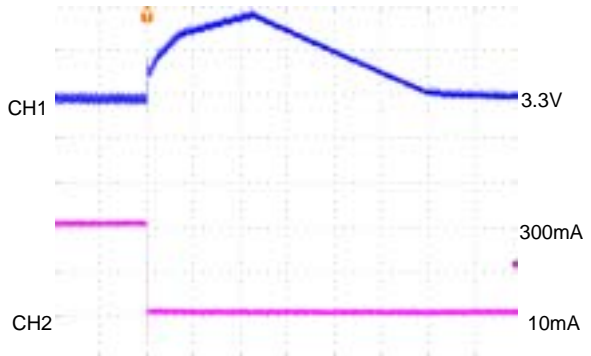

200µsec/div
 CH1: V_{OUT1} , AC-COUPLED, 50mV/div
 CH2: I_{OUT1} , 150mA/div

< 1 ch. Step-Up DC/DC Controller >

< $V_{OUT1} = 0.9V$, $V_{IN} = 3.3V$ $I_{OUT1} = 100\mu A \leftrightarrow 300mA$ >

○ PWM Control

$F_{OSC} = 300kHz$, $V_{OUT1} = 0.9V$
 $V_{IN} = 3.3V$, $I_{OUT1} = 100\mu A \rightarrow 300mA$

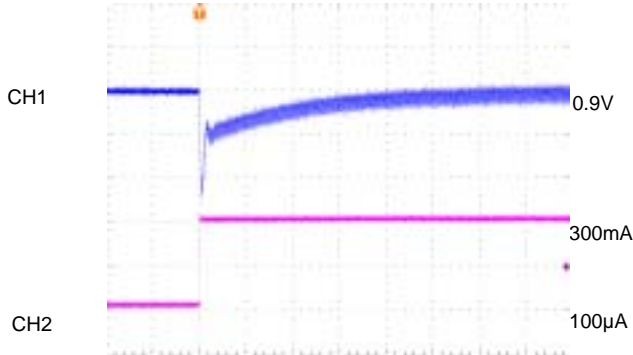

200µsec/div
 CH1: V_{OUT1} , AC-COUPLED, 20mV/div
 CH2: I_{OUT1} , 150mA/div

$F_{OSC} = 300kHz$, $V_{OUT1} = 0.9V$
 $V_{IN} = 3.3V$, $I_{OUT1} = 300mA \rightarrow 100\mu A$

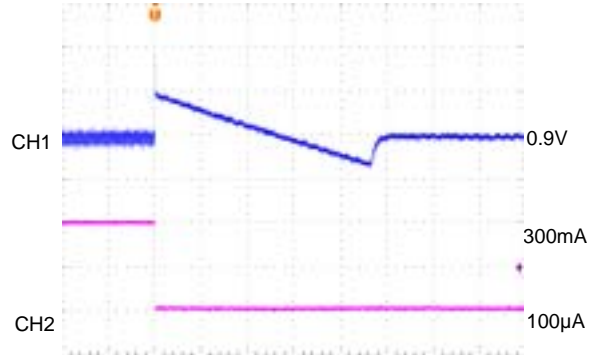

4msec/div
 CH1: V_{OUT1} , AC-COUPLED, 20mV/div
 CH2: I_{OUT1} , 150mA/div

○ PWM/PFM Switching Control

$F_{OSC} = 300kHz$, $V_{OUT1} = 0.9V$
 $V_{IN} = 3.3V$, $I_{OUT1} = 100\mu A \rightarrow 300mA$

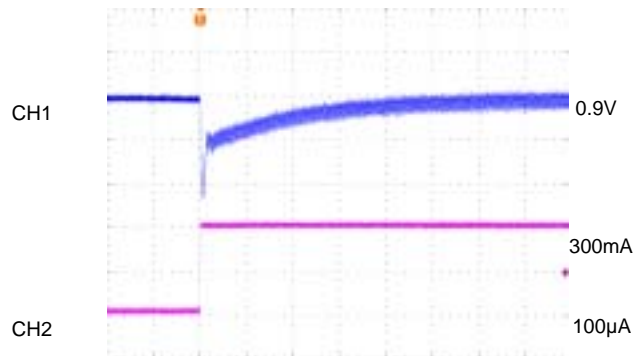

200µsec/div
 CH1: V_{OUT1} , AC-COUPLED, 20mV/div
 CH2: I_{OUT1} , 150mA/div

$F_{OSC} = 300kHz$, $V_{OUT1} = 0.9V$
 $V_{IN} = 3.3V$, $I_{OUT1} = 300mA \rightarrow 100\mu A$

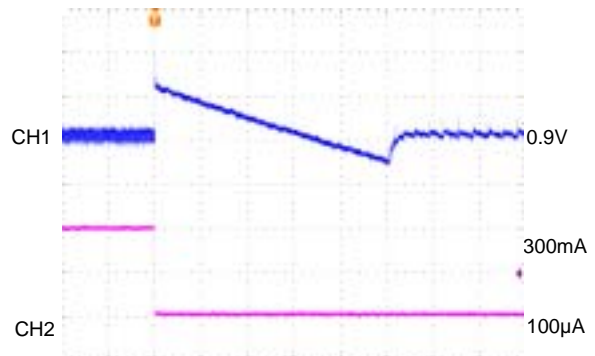

4msec/div
 CH1: V_{OUT1} , AC-COUPLED, 20mV/div
 CH2: I_{OUT1} , 150mA/div

< 1 ch. Step-Up DC/DC Controller >

< $V_{OUT1} = 0.9V$, $V_{IN} = 3.3V$ $I_{OUT1} = 10mA \leftrightarrow 300mA$ >

○ PWM Control

FOSC=300kHz, $V_{OUT1}=0.9V$
 $V_{IN}=3.3V$, $I_{OUT1}=10mA \rightarrow 300mA$

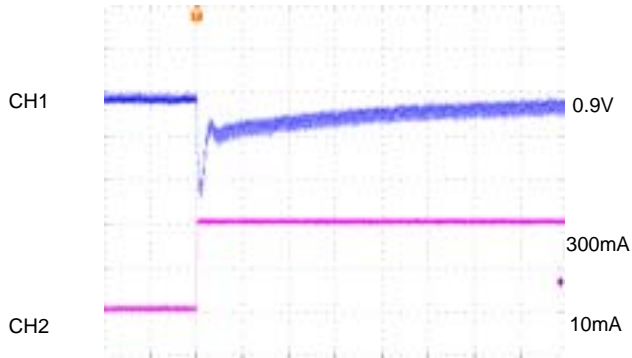

100µsec/div
 CH1: V_{OUT1} , AC-COUPLED, 20mV/div
 CH2: I_{OUT1} , 150mA/div

FOSC=300kHz, $V_{OUT1}=0.9V$
 $V_{IN}=3.3V$, $I_{OUT1}=300mA \rightarrow 10mA$

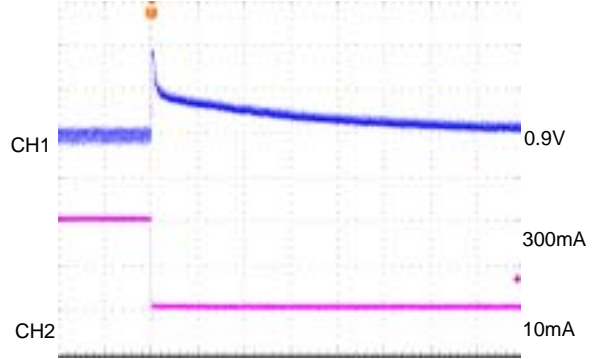

100µsec/div
 CH1: V_{OUT1} , AC-COUPLED, 20mV/div
 CH2: I_{OUT1} , 150mA/div

○ PWM/PFM Switching Control

FOSC=300kHz, $V_{OUT1}=0.9V$
 $V_{IN}=3.3V$, $I_{OUT1}=10mA \rightarrow 300mA$

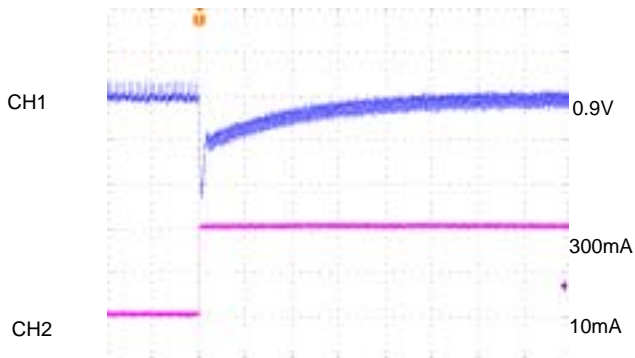

200µsec/div
 CH1: V_{OUT1} , AC-COUPLED, 20mV/div
 CH2: I_{OUT1} , 150mA/div

FOSC=300kHz, $V_{OUT1}=0.9V$
 $V_{IN}=3.3V$, $I_{OUT1}=300mA \rightarrow 10mA$

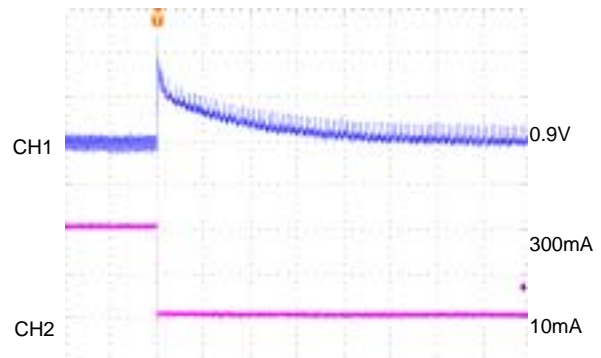

200µsec/div
 CH1: V_{OUT1} , AC-COUPLED, 20mV/div
 CH2: I_{OUT1} , 150mA/div

< 1 ch. Step-Up DC/DC Controller >

< PWM Control ⇔ PWM / PFM Switching Control >

FOSC=300kHz, VOUT1=3.3V
VIN=5.0V, IOUT1=5mA PWM1 'L'→'H'

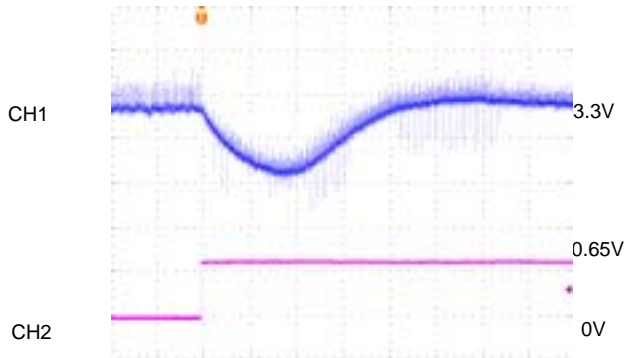

400µsec/div
CH1:Vout1, AC-COUPLED, 10mV/div
CH2:PWM1, 0.5V/div

FOSC=300kHz, VOUT1=3.3V
VIN=5.0V, IOUT1=5A PWM1 'H'→'L'

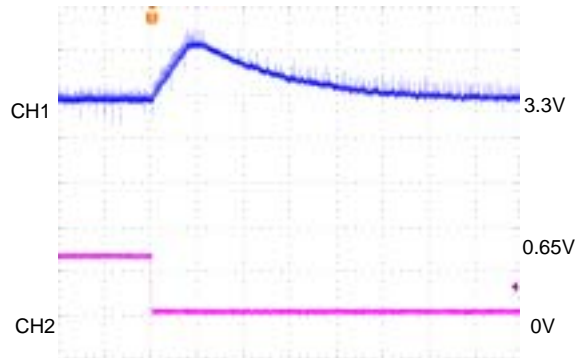

200µsec/div
CH1:Vout1, AC-COUPLED, 20mV/div
CH2:PWM1, 0.5V/div

< Soft-Start Wave Form >

FOSC=300kHz, VOUT1=3.3V
VIN=5.0V, IOUT1=300mA
EN1 'L'→'H', CIN=47µF

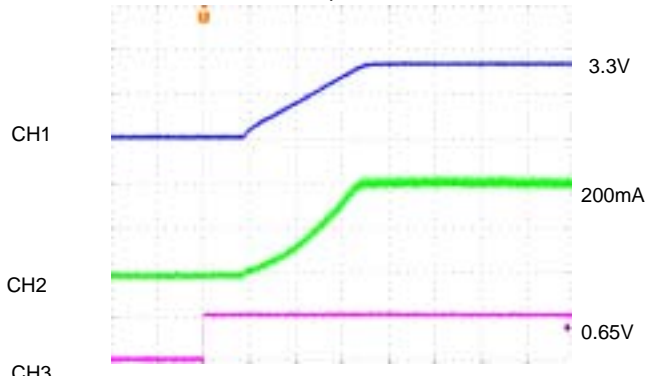

4ms/div
CH1:Vout1, 2.0V/div
CH2:Iin1, 100mA/div
CH3:EN1, 0.5V/div

FOSC=300kHz, VOUT1=3.3V
VIN=5.0V, IOUT1=100mA
EN1 'L'→'H', CIN=47µF

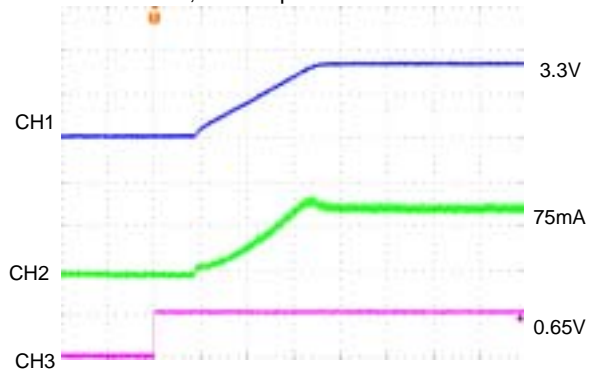

4ms/div
CH1:Vout1, 2.0V/div
CH2:Iin1, 50mA/div
CH3:EN1, 0.5V/div

* EN2=GND

< 2 ch. Inverting DC/DC Controller >

< VOUT2 = - 7.5V, VIN = 3.3V IOUT2 = - 100 μ A \leftrightarrow - 50mA > (Tantalum Capacitor use)

○ PWM Control

FOSC=180kHz, VOUT2=-7.5V
VIN=3.3V, IOUT2=-100 μ A \rightarrow -50mA

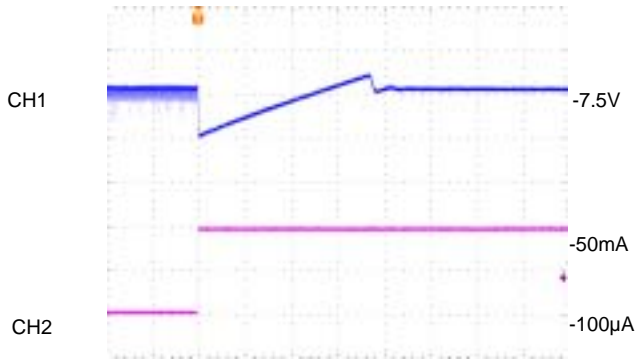

10msec/div
CH1:Vout2 , AC-COUPLED, 50mV/div
CH2:Iout2 , 50mA/div

FOSC=180kHz, VOUT2=-7.5V
VIN=3.3V, IOUT2=-50mA \rightarrow -100 μ A

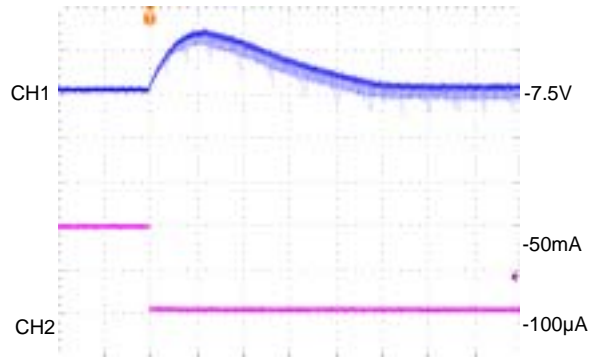

200 μ sec/div
CH1:Vout2 , AC-COUPLED, 50mV/div
CH2:Iout2 , 50mA/div

○ PWM/PFM Switching Control

FOSC=180kHz, VOUT2=-7.5V
VIN=3.3V, IOUT2=-100 μ A \rightarrow -50mA

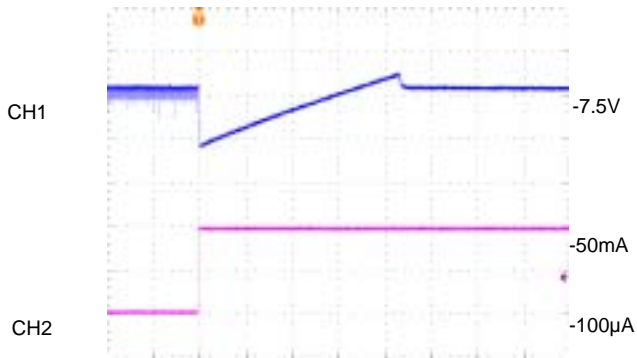

10msec/div
CH1:Vout2 , AC-COUPLED, 50mV/div
CH2:Iout2 , 50mA/div

FOSC=180kHz, VOUT2=-7.5V
VIN=3.3V, IOUT2=-50mA \rightarrow -100 μ A

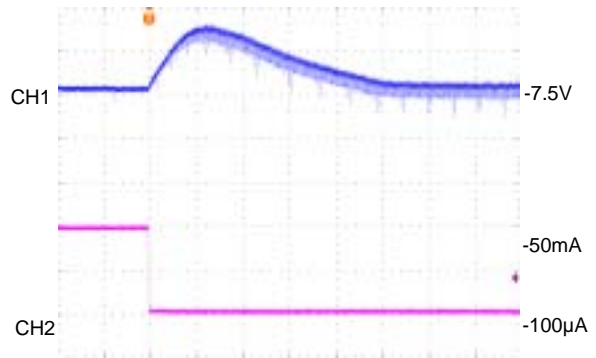

200 μ sec/div
CH1:Vout2 , AC-COUPLED, 50mV/div
CH2:Iout2 , 50mA/div

< 2 ch. Inverting DC/DC Controller >

< $V_{OUT2} = -7.5V$, $V_{IN} = 3.3V$ $I_{OUT2} = -100\mu A \leftrightarrow -20mA$ >

(Ceramic Capacitor use when coil current is discontinued.)

○ PWM Control

FOSC=180kHz, $V_{OUT2}=-7.5V$
 $V_{IN}=3.3V$, $I_{OUT2}=-100\mu A \rightarrow -20mA$

FOSC=180kHz, $V_{OUT2}=-7.5V$
 $V_{IN}=3.3V$, $I_{OUT2}=-20mA \rightarrow -100\mu A$

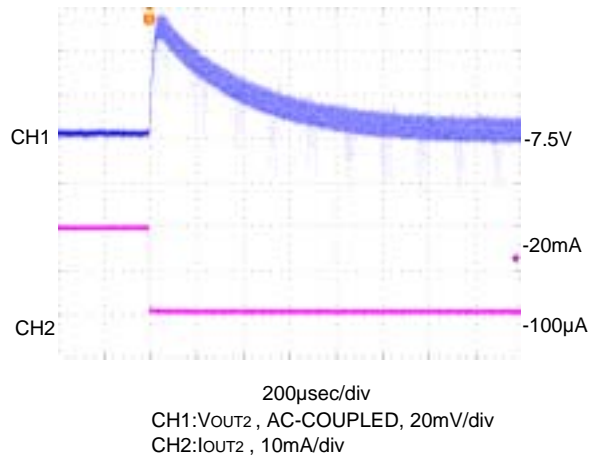
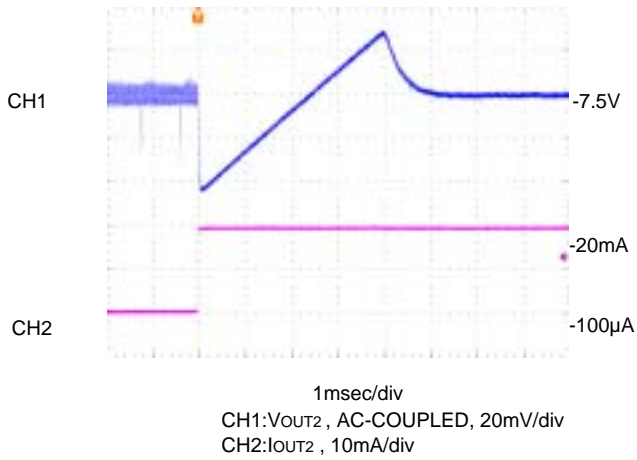

○ PWM/PFM Switching Control

FOSC=180kHz, $V_{OUT2}=-7.5V$
 $V_{IN}=3.3V$, $I_{OUT2}=-100\mu A \rightarrow -20mA$

FOSC=180kHz, $V_{OUT2}=-7.5V$
 $V_{IN}=3.3V$, $I_{OUT2}=-20mA \rightarrow -100\mu A$

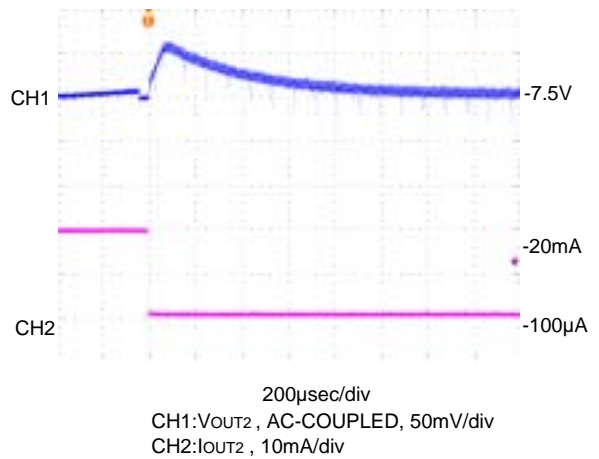
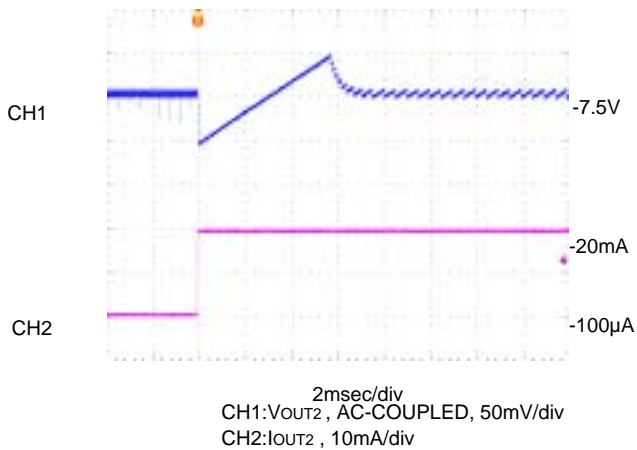

< 2 ch. Inverting DC/DC Controller >

< $V_{OUT2} = -7.5V$, $V_{IN} = 3.3V$ $I_{OUT2} = -1mA \leftrightarrow -20mA$ >

○ PWM Control

FOSC=180kHz, $V_{OUT2}=-7.5V$
 $V_{IN}=3.3V$, $I_{OUT2}=-1mA \rightarrow -20mA$

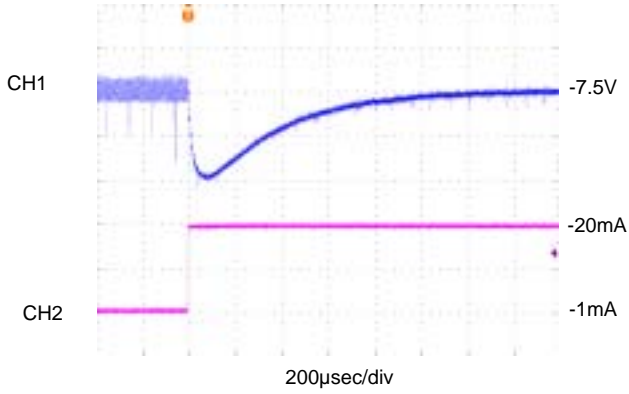

CH1: V_{OUT2} , AC-COUPLED, 20mV/div
 CH2: I_{OUT2} , 10mA/div

FOSC=180kHz, $V_{OUT2}=-7.5V$
 $V_{IN}=3.3V$, $I_{OUT2}=-20mA \rightarrow -1mA$

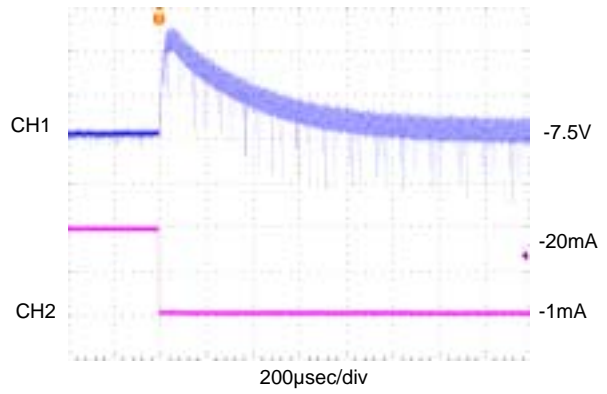

CH1: V_{OUT2} , AC-COUPLED, 20mV/div
 CH2: I_{OUT2} , 10mA/div

○ PWM / PFM Switching Control

FOSC=180kHz, $V_{OUT2}=-7.5V$
 $V_{IN}=3.3V$, $I_{OUT2}=-1mA \rightarrow -20mA$

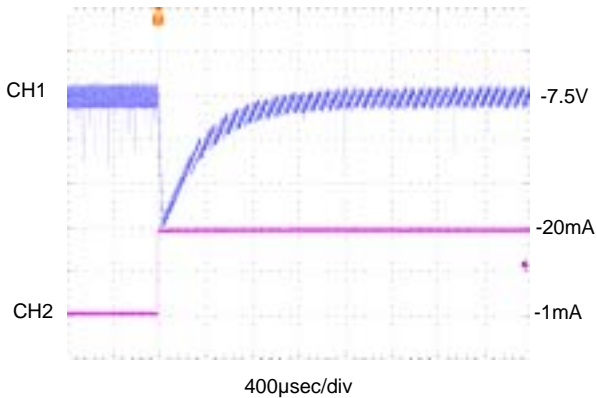

CH1: V_{OUT2} , AC-COUPLED, 20mV/div
 CH2: I_{OUT2} , 10mA/div

FOSC=180kHz, $V_{OUT2}=-7.5V$
 $V_{IN}=3.3V$, $I_{OUT2}=-20mA \rightarrow -1mA$

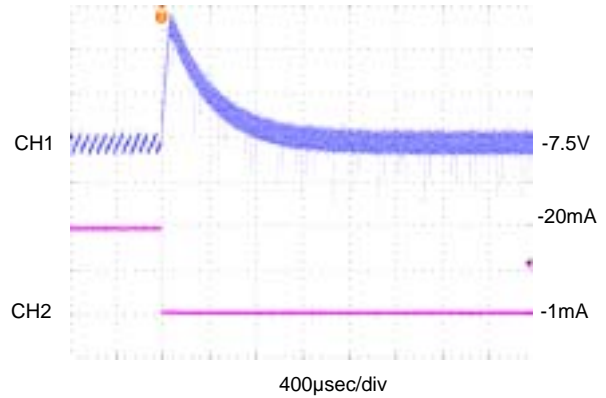

CH1: V_{OUT2} , AC-COUPLED, 20mV/div
 CH2: I_{OUT2} , 10mA/div

< 2 ch. Inverting DC/DC Controller >

< PWM Control ↔ PWM / PFM Switching Control >

FOSC=180kHz, V_{OUT2}=-7.5V
VIN=3.3V, I_{OUT2}= - 5mA PWM2 'L'→'H'

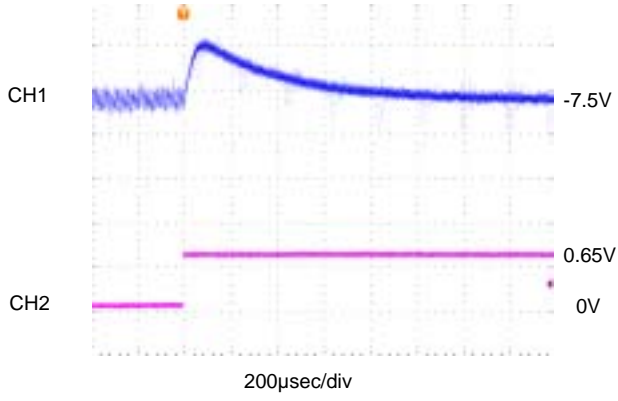

CH1:V_{OUT2} , AC-COUPLED ,20mV/div
CH2:PWM₂ , 0.5V/div

FOSC=180kHz, V_{OUT2}=-7.5V
VIN=3.3V, I_{OUT2}= - 5mA PWM2 'H'→'L'

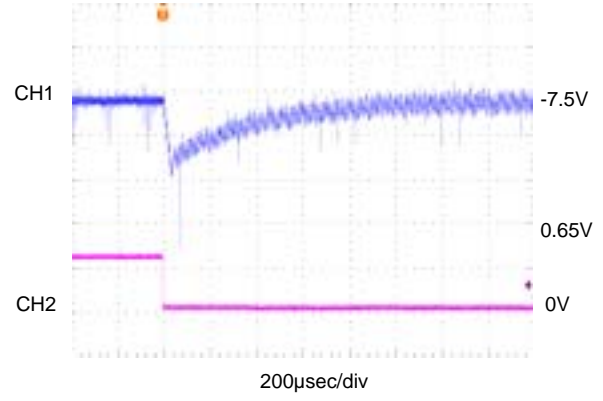

CH1:V_{OUT2} , AC-COUPLED ,20mV/div
CH2:PWM₂ , 0.5V/div