

ATTN: Paul

STR-D SERIES

SANKEN HYBRID VOLTAGE REGULATOR MODULE

PART NUMBER STR-D10057

Date: February 22, 1988

Specification No.: SSE16935

Post-It™ brand fax transmittal memo 7671

To	From
Fax #	

1. Features:

- a. Hybrid Voltage Regulator Module incorporated triple diffused planar transistor chips.
- b. Transfer Molded.
- c. For TV Switch Mode Power Supply.
- d. Fixed Output Voltage.

2. Equivalent Circuit

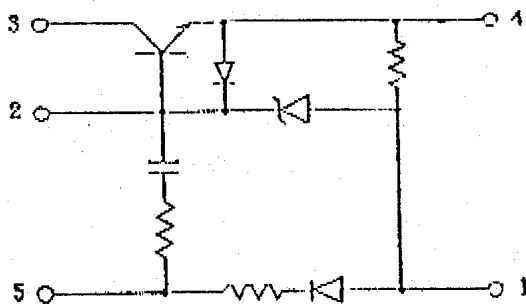

- 1. V_{OUT} ()
- 2. BASE
- 3. INPUT (C)
- 4. EARTH (E)
- 5. DRIVE INPUT

3. Outline Drawing, Marking, and Pin Connections

Refer to Figure 1.

4. The type number and lot number shall be legibly marked by white color.

5. Absolute Maximum Ratings

Description	Symbol	Unit	Rating
Maximum Peak Input Voltage	V_{IN}	V	800
Input Current	I_{IN}	A	1.5 (Pulse 3.0)
Maximum Power Dissipation	P_D	W	20 ($T_{c_1} = 100^{\circ}C$) (* NOTE 1)
Operating Temperature	T_c	$^{\circ}C$	-20 - +125 (T_{c_2}) (* NOTE 2)
Storage Temperature	T_{stg}	$^{\circ}C$	-30 - +125
Power Transistor Junction Temperature	T_J	$^{\circ}C$	+150
Output Current	I_o	A	0.4 ($V_o = 12V$)

* NOTE 1: T_{c_1} - Temperature was measured directly on the plastic case under transistor die.

* NOTE 2: Recommendation case temperature T_{c_1} (T_{c_2}) = 100 $^{\circ}C$ Max.
(T_{c_2} : Internal flame temperature)

Electrical Characteristics

Description	Symbol	Conditions	Ratings
Fixed Reference Voltage (Detecting Voltage)	V _{REF}	I _{IN} = 17mA Measurement Circuit 1	5.35 ± 0.20V
Collector - Emitter (Saturation Voltage)	V _{CE(SAT)}	I _C = 300mA, I _B = 50mA	1.0V Max.
DC Gain	h _{FE}	V _{CE} = 4V, I _C = 100mA	15 Min/45 Max
Collector Cut Off Current	I _{CEX}	V _{CE} = 800V, V _{BE} = -1.5V	1.0mA Max
Base Emitter Saturation Voltage	V _{BE(SAT)}	I _C = 300mA, I _B = 50mA	1.5V Max
Thermal Resistance	θ _{jc}	Between Junction & Stem Upper Surface	1.8 °C/W Max
Switching Time		See Test Circuit 2	t _s 7μsec Max
			t _f 1.0μsec Max

Characteristics

Suggested Silicone Grease

- C746/C747: SHIN-ETSU CHEMICAL INDUSTRY CO., LTD.
- YG6260: TOSHIBA SILICONE CO., LTD.
- SC102: TORAY SILICONE CO., LTD.

7. Application Circuit

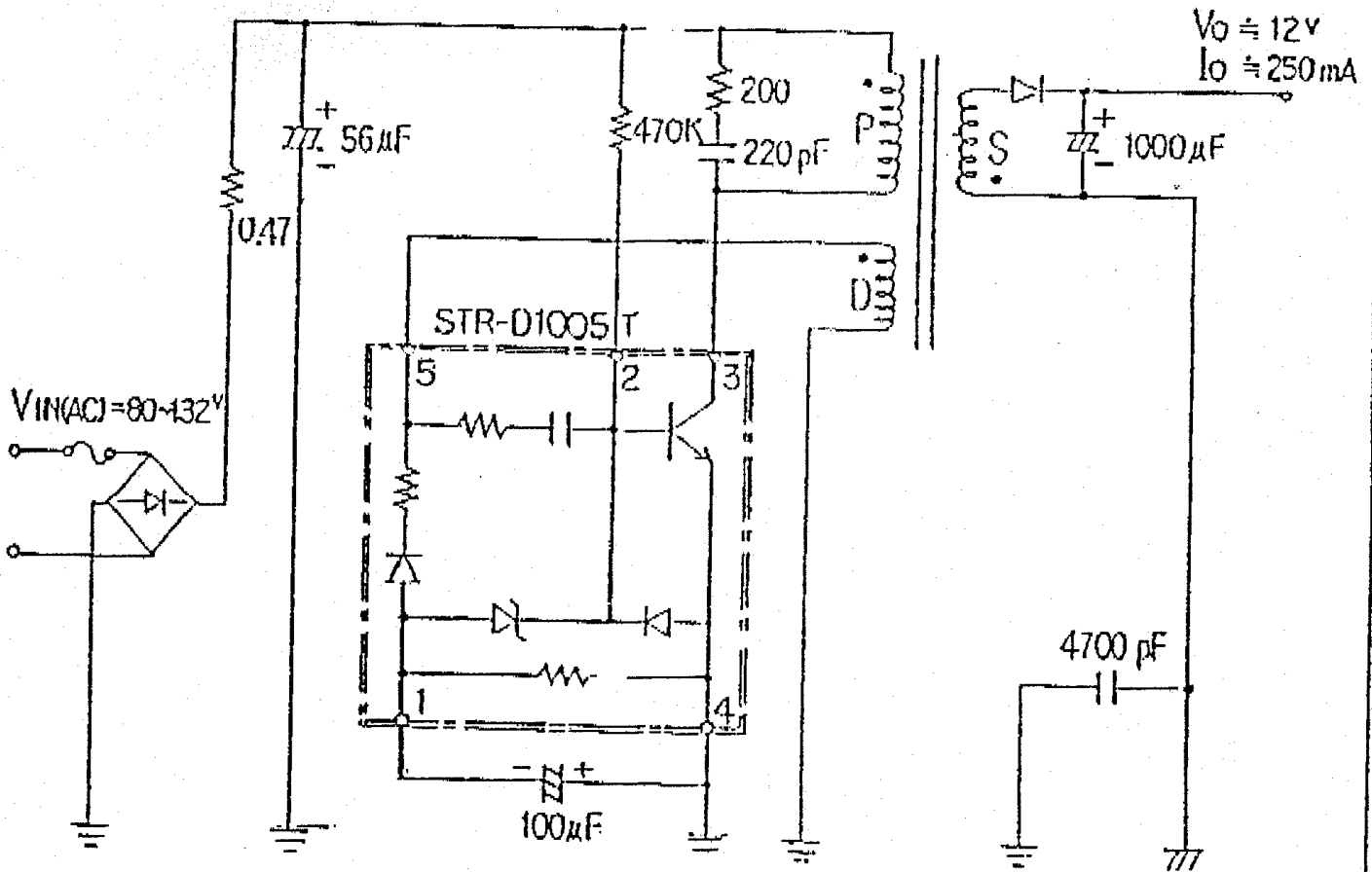

CORE SIZE : EE-16

GAP(CENTER) : 0.2mm

$L_p \approx 6.4mH$

P : $\phi 0.18$ 220 T

D : $\phi 0.18$ 9 T

S : $\phi 0.26$ 21 T

OUTPUT VOLTAGE V_O CAN BE VARIED BY CHANGING TRANSFORMER TURN RATIOS.

Measurement Circuit 1.

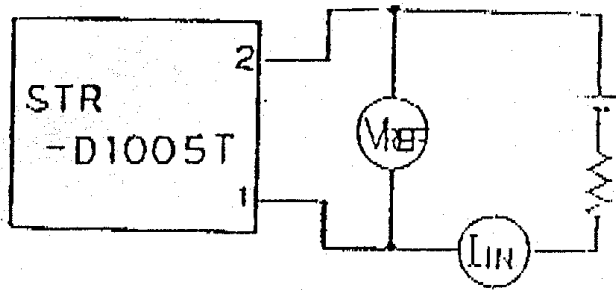

Measurement Circuit 2.

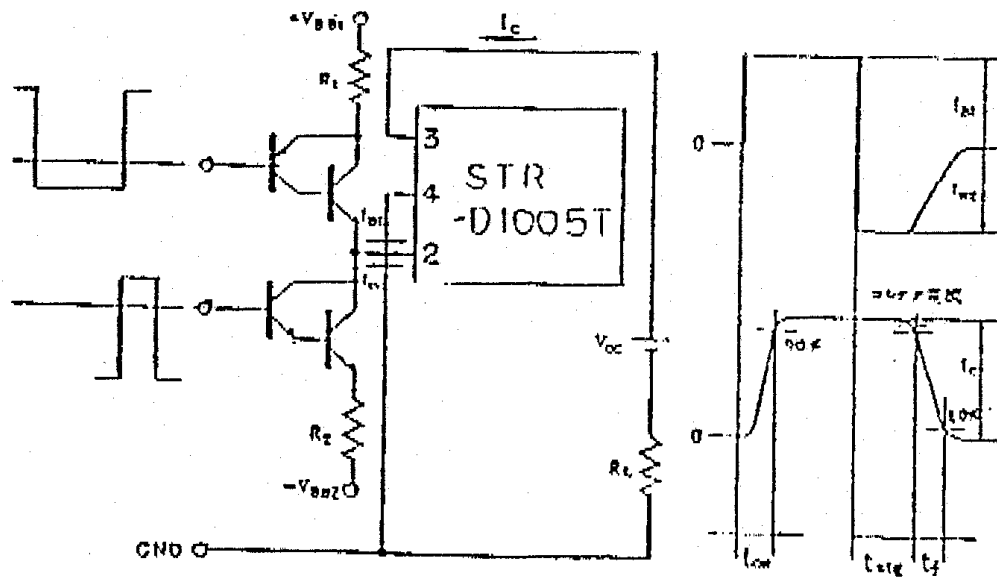

$$I_c = 300 \text{ mA} \quad R_L = 333 \Omega$$

$$I_{b1} = 50 \text{ mA} \quad I_{b2} = 100 \text{ mA}$$

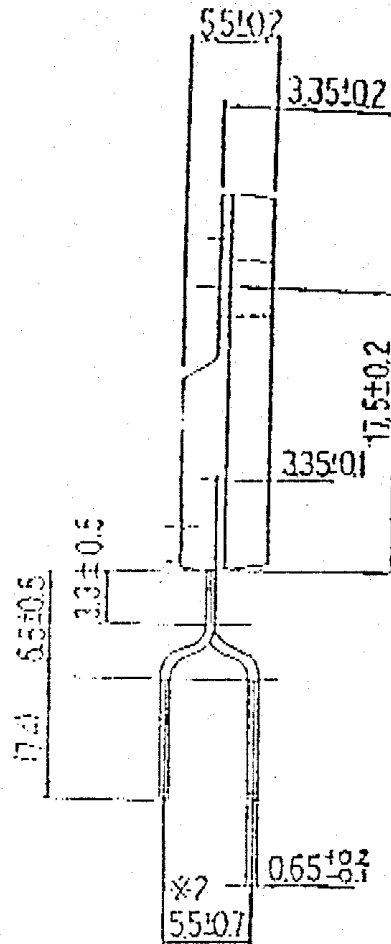
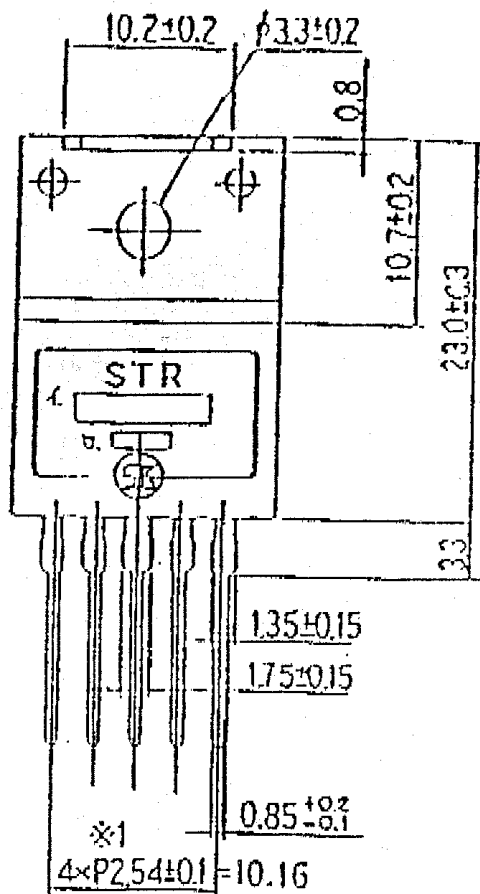

A. Type Number : D1005 T

B. Lot Number

1st letter: The last numerical figure of calendar year

2nd letter: Month (1 to 9 for Jan to Sep.,
0 for Oct.,
N for Nov.,
D for Dec.)

3rd, 4th letter: Date

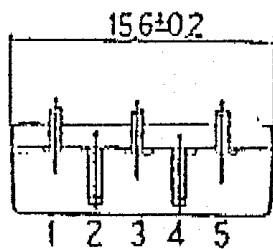

1. V_{cc} (-)
2. BASE
3. INPUT (C)
4. EARTH (E)
5. DRIVE INPUT

FIGURE 1