

PC410

Compact, Surface Mount Ultra-high Speed Response OPIC Photocoupler

■ Features

1. Opaque, mini-flat package
2. Ultra-high speed response
(t_{PLH} , t_{PHL} : TYP. 50ns at $R_L=350\Omega$)
3. Isolation voltage between input and output
(V_{iso} : 2 500 V_{rms})
4. Instantaneous common mode rejection
voltage CM_H : TYP. 500V/ μs
5. Recognized by UL, file No.64380

■ Applications

1. Hybrid substrate which requires high density mounting
2. Personal computers, office computers and peripheral equipment
3. Electronic musical instruments
4. Audio equipment

■ Package Specifications

Model No.	Package specifications	Diameter of reel	Tape width
PC410	Taping package(Net:3 000pcs.)	$\phi 370mm$	12mm
PC410T	Taping package(Net: 750pcs.)	$\phi 178mm$	12mm
PC410Z	Sleeve package(Net: 100pcs.)	—	—

■ Absolute Maximum Ratings

($T_a = 25^\circ C$)

Parameter		Symbol	Rating	Unit
Input	*1 Forward current	I_F	20	mA
	Reverse voltage	V_R	5	V
	Power dissipation	P	40	mW
Output	*2 Supply voltage	V_{CC}	7	V
	High level output voltage	V_{OH}	7	V
	Low level output current	I_{OL}	50	mA
	Output collector power dissipation	P_O	85	mW
*3 Isolation voltage		V_{iso}	2 500	V_{rms}
Operating temperature		T_{opr}	0 to +70	$^\circ C$
Storage temperature		T_{stg}	-40 to +125	$^\circ C$
*4 Soldering temperature		T_{sol}	260	$^\circ C$

*1 $T_a = 0$ to $+70^\circ C$

*2 For 1 minute MAX.

*3 AC for 1 minute, 40 to 60% RH. Apply the specified voltage between the whole of the electrode pins on the input side and the whole of the electrode pins on the output side.

*4 For 10 seconds.

■ Outline Dimensions

(Unit : mm)

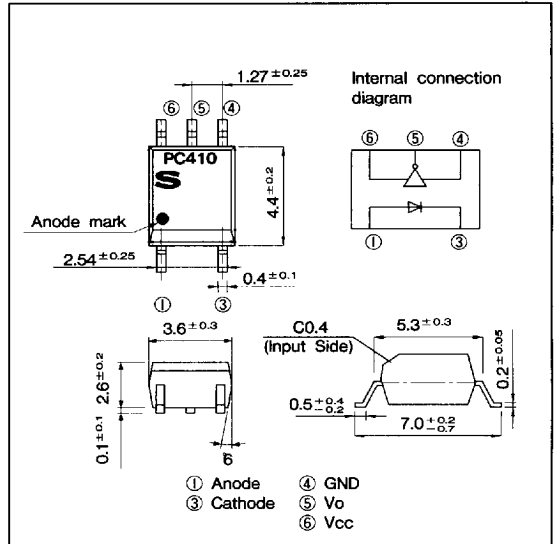

* "OPIC" (Optical IC) is a trademark of the SHARP Corporation. An OPIC consists of a light-detecting element and signal-processing circuit integrated onto a single chip.

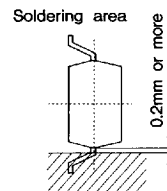

■ Electro-optical Characteristics

(Ta=0 to +70°C unless otherwise specified)

Parameter		Symbol	Conditions	MIN.	TYP.	MAX.	Unit	
Input	Forward voltage	V _F	Ta=25°C, I _F =10mA	—	1.6	1.9	V	
	Reverse current	I _R	Ta=25°C, V _R =5V	—	—	10	μA	
	Terminal capacitance	C _t	Ta=25°C, V=0, f=1MHz	—	60	150	pF	
Output	Low level output voltage	V _{OL}	I _{OL} =13mA, V _{CC} =5.5V, I _F =5mA	—	—	0.6	V	
	High level output current	I _{OH}	V _{CC} =V _O =5.5V, I _F =250 μA	—	2	250	μA	
	Low level supply current	I _{CCL}	V _{CC} =5.5V, I _F =10mA	—	13	18	mA	
	High level supply current	I _{CCH}	V _{CC} =5.5V, I _F =0	—	7	15	mA	
Transfer characteristics	"H→L" threshold input current	I _{FHL}	V _{CC} =5V, V _O =0.8V, R _L =350Ω	—	2.5	5	mA	
	Isolation resistance	R _{ISO}	Ta=25°C, DC500V, 40 to 60% RH	5×10 ¹⁰	10 ¹¹	—	Ω	
	Floating capacitance	C _f	Ta=25°C, V=0, f=1MHz	—	0.6	5	pF	
	*Response time	"H→L" propagation delay time	t _{PHL}	Ta=25°C V _{CC} =5V, I _F =7.5mA R _L =350Ω, C _L =15pF Fig. 1	—	50	120	ns
		"L→H" propagation delay time	t _{PLH}		—	50	120	
		Fall time	t _f		—	30	60	
		Rise time	t _r		—	30	60	
CMR	Instantaneous common mode rejection voltage "High level output"	CM _H	I _F =0 V _O (MIN.)=2V	Ta=25°C V _{CC} =5V V _{CM} =10V(Peak) R _L =350Ω Fig. 2	100	500	—	
	Instantaneous common mode rejection voltage "Low level output"	CM _L	I _F =5mA V _O (MAX.)=0.8V		—100	—500		—

Note) All typical values : at Ta=25°C, V_{CC}=5V

Each characteristics shall be measured under opaque condition.

■ Recommended Operation Conditions

Parameter	Symbol	MIN.	MAX.	Unit
Low level input current	I _{FL}	0	250	μA
High level input current	I _{FH}	7	15	mA
Supply voltage	V _{CC}	4.5	5.5	V
Fanout (TTL load)	N	—	8	—
Operating temperature	T _{opr}	0	70	°C

Connect a by-pass ceramic capacitor (0.01 to 0.1 μF) between V_{CC} and GND at the position within 1 cm from lead pin.

 Photocouplers

Fig. 1 Test Circuit for t_{PHL} , t_{PLH} , t_r and t_f

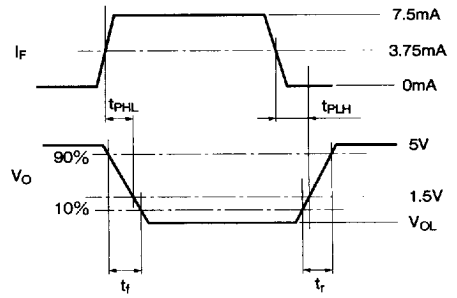
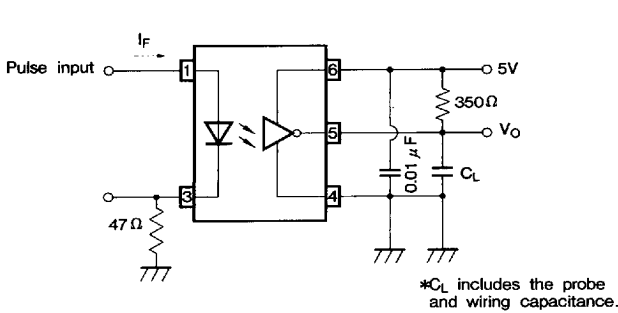

Fig. 2 Test Circuit for Instantaneous Common Mode Rejection Voltage

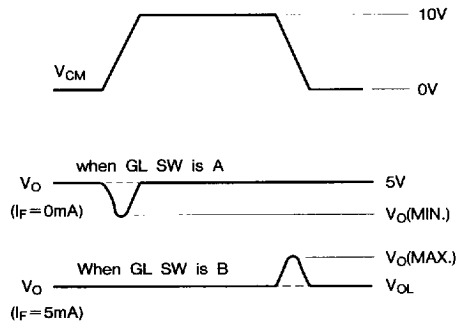
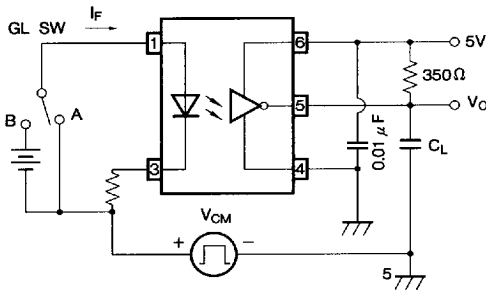

Fig. 3 Collector Power Dissipation vs. Ambient Temperature

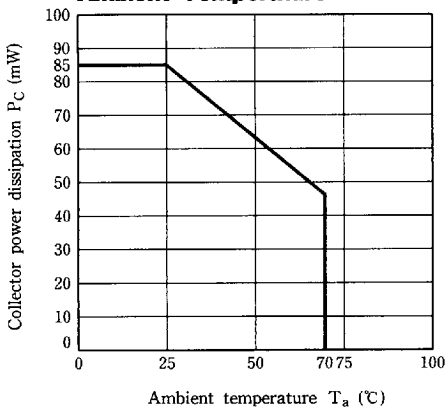

Fig. 4 Forward Current vs. Forward Voltage

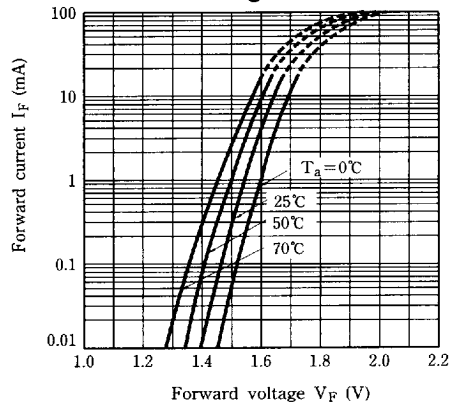

Fig. 5 High Level Output Current vs. Ambient Temperature

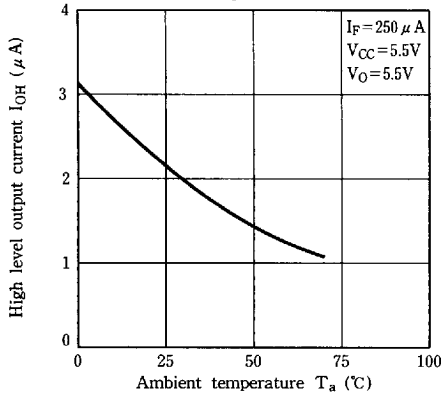

Fig. 6 Low Level Output Voltage vs. Ambient Temperature

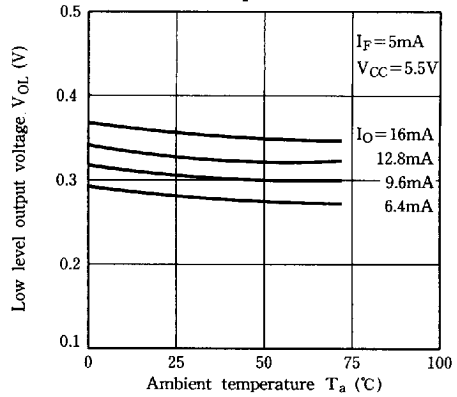

Fig. 7-a Output Voltage vs. Forward Current

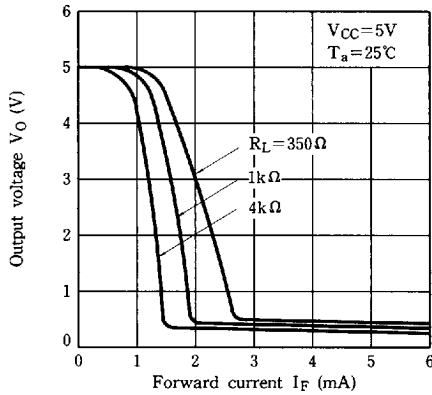

Fig. 7-b Output Voltage vs. Forward Current (Ambient Temp. Characteristics)

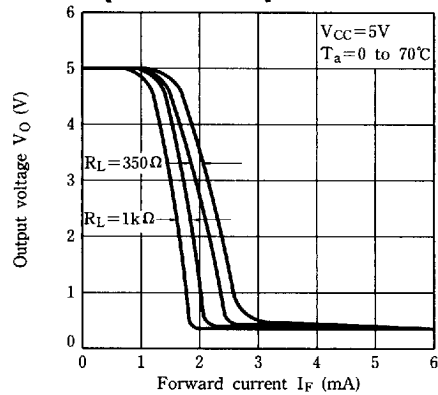

Fig. 8 Propagation Delay Time vs. Forward Current

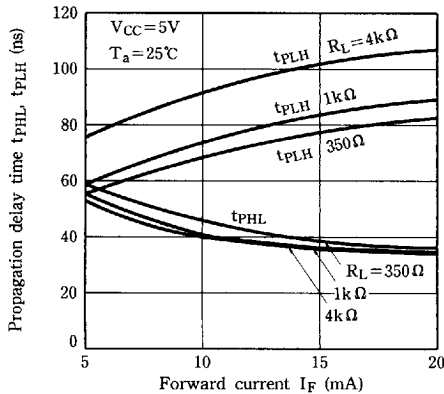

Fig. 9 Propagation Delay Time vs. Ambient Temperature

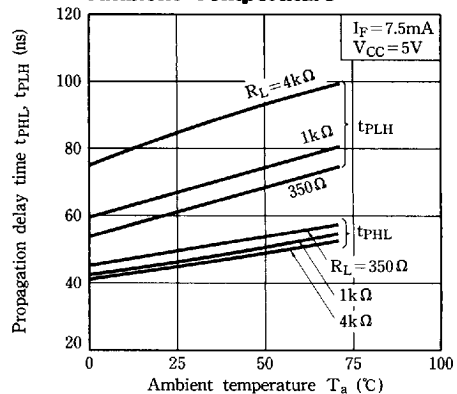
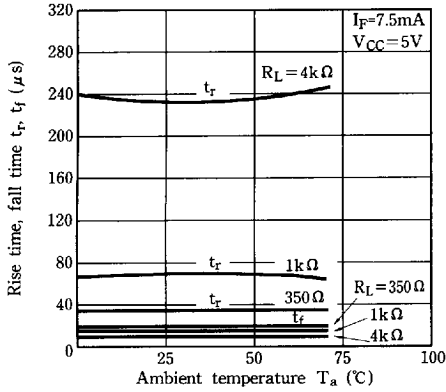

Fig.10 Rise Time, Fall Time vs. Ambient Temperature



■ Precautions for Use

- (1) Handle this product the same as with other integrated circuits against static electricity.
- (2) As for other general cautions, refer to the chapter "Precautions for Use." (Page 78 to 93).