

MPSA06

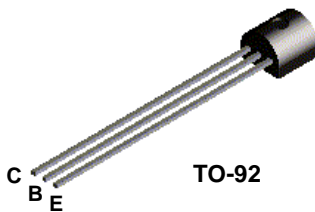

MMBTA06

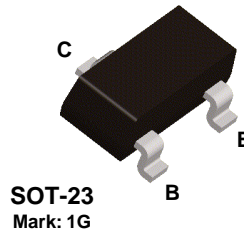

PZTA06

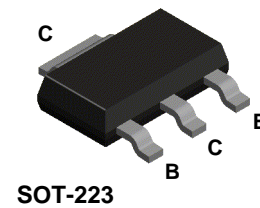

NPN General Purpose Amplifier

This device is designed for general purpose amplifier applications at collector currents to 300 mA. Sourced from Process 33.

Absolute Maximum Ratings*

TA = 25°C unless otherwise noted

| Symbol | Parameter | Value | Units |
|-----------------------------------|--|-------------|-------|
| V _{CEO} | Collector-Emitter Voltage | 80 | V |
| V _{CBO} | Collector-Base Voltage | 80 | V |
| V _{EBO} | Emitter-Base Voltage | 4.0 | V |
| I _C | Collector Current - Continuous | 500 | mA |
| T _J , T _{stg} | Operating and Storage Junction Temperature Range | -55 to +150 | °C |

*These ratings are limiting values above which the serviceability of any semiconductor device may be impaired.

NOTES:

- 1) These ratings are based on a maximum junction temperature of 150 degrees C.
- 2) These are steady state limits. The factory should be consulted on applications involving pulsed or low duty cycle operations.

Thermal Characteristics

TA = 25°C unless otherwise noted

| Symbol | Characteristic | Max | | | Units |
|------------------|---|--------|----------|----------|-------|
| | | MPSA06 | *MMBTA06 | **PZTA06 | |
| P _D | Total Device Dissipation | 625 | 350 | 1,000 | mW |
| | Derate above 25°C | 5.0 | 2.8 | 8.0 | mW/°C |
| R _{θJC} | Thermal Resistance, Junction to Case | 83.3 | | | °C/W |
| R _{θJA} | Thermal Resistance, Junction to Ambient | 200 | 357 | 125 | °C/W |

* Device mounted on FR-4 PCB 1.6" X 1.6" X 0.06."

** Device mounted on FR-4 PCB 36 mm X 18 mm X 1.5 mm; mounting pad for the collector lead min. 6 cm².

NPN General Purpose Amplifier

(continued)

Electrical Characteristics

TA = 25°C unless otherwise noted

| Symbol | Parameter | Test Conditions | Min | Max | Units |
|----------------------------|---------------------------------------|---|-----|-----|---------------|
| OFF CHARACTERISTICS | | | | | |
| $V_{(BR)CEO}$ | Collector-Emitter Sustaining Voltage* | $I_C = 1.0 \text{ mA}, I_B = 0$ | 80 | | V |
| $V_{(BR)EBO}$ | Emitter-Base Breakdown Voltage | $I_E = 100 \text{ } \mu\text{A}, I_C = 0$ | 4.0 | | V |
| I_{CEO} | Collector-Cutoff Current | $V_{CE} = 60 \text{ V}, I_B = 0$ | | 0.1 | μA |
| I_{CBO} | Collector-Cutoff Current | $V_{CB} = 80 \text{ V}, I_E = 0$ | | 0.1 | μA |

ON CHARACTERISTICS

| | | | | | |
|---------------|--------------------------------------|---|------------|------|---|
| h_{FE} | DC Current Gain | $I_C = 10 \text{ mA}, V_{CE} = 1.0 \text{ V}$ $I_C = 100 \text{ mA}, V_{CE} = 1.0 \text{ V}$ | 100 100 | | |
| $V_{CE(sat)}$ | Collector-Emitter Saturation Voltage | $I_C = 100 \text{ mA}, I_B = 10 \text{ mA}$ | | 0.25 | V |
| $V_{BE(on)}$ | Base-Emitter On Voltage | $I_C = 100 \text{ mA}, V_{CE} = 1.0 \text{ V}$ | | 1.2 | V |

SMALL SIGNAL CHARACTERISTICS

| | | | | | |
|-------|----------------------------------|---|-----|--|-----|
| f_T | Current Gain - Bandwidth Product | $I_C = 10 \text{ mA}, V_{CE} = 2.0 \text{ V},$ $f = 100 \text{ MHz}$ | 100 | | MHz |
|-------|----------------------------------|---|-----|--|-----|

*Pulse Test: Pulse Width $\leq 300 \text{ } \mu\text{s}$, Duty Cycle $\leq 2.0\%$

Spice Model

NPN (Is=8.324f Xti=3 Eg=1.11 Vaf=100 Bf=12.16K Ne=1.368 Ise=73.27f Ikf=.1096 Xtb=1.5 Br=11.1 Nc=2 Isc=0 Ikr=0 Rc=.25 Cjc=18.36p Mjc=.3843 Vjc=.75 Fc=.5 Cje=55.61p Mje=.3834 Vje=.75 Tr=72.15n Tf=516.1p Itf=.5 Vtf=4 Xtf=6 Rb=10)

Typical Characteristics

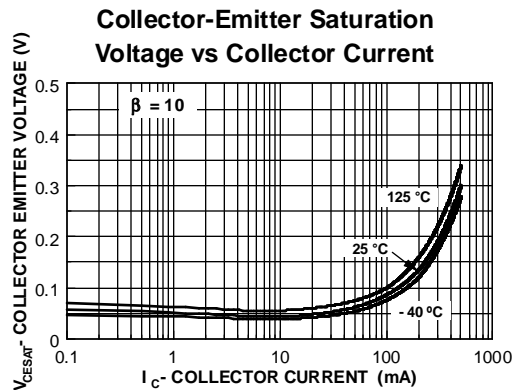
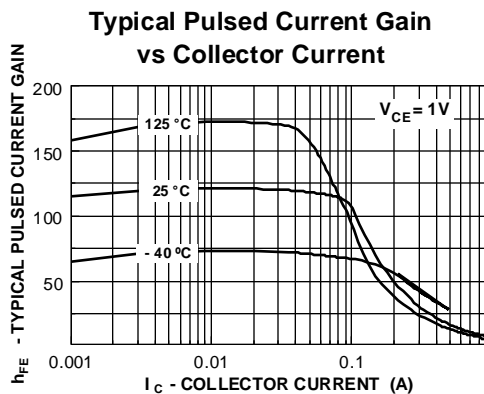

Typical Characteristics (continued)

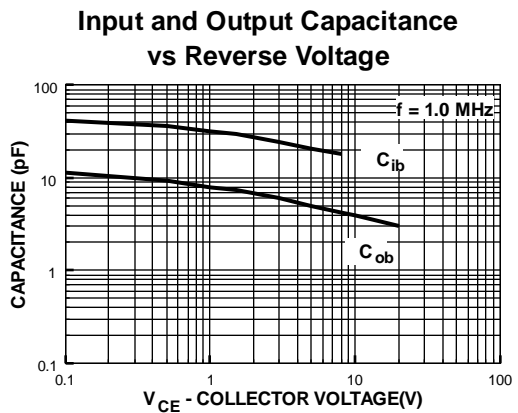
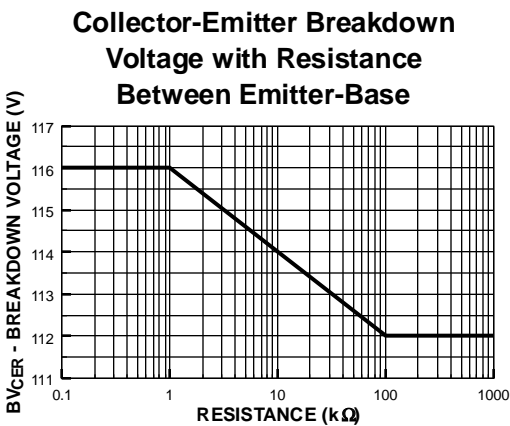
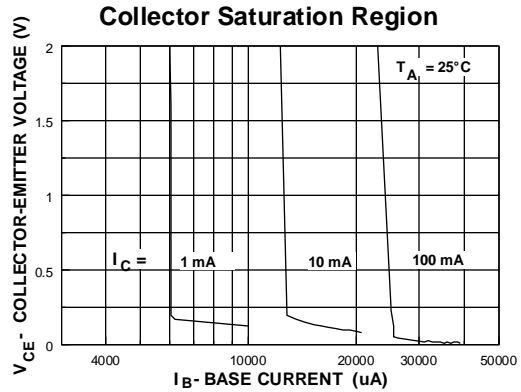
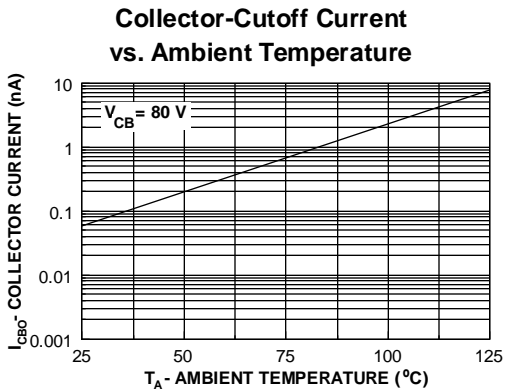
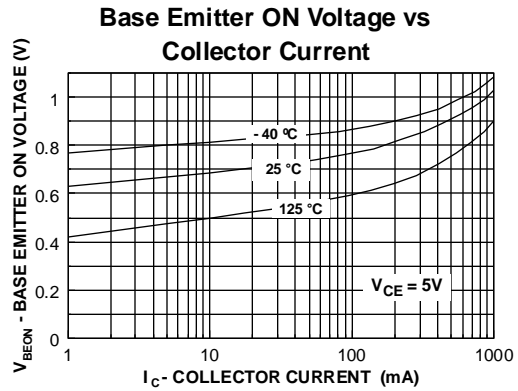
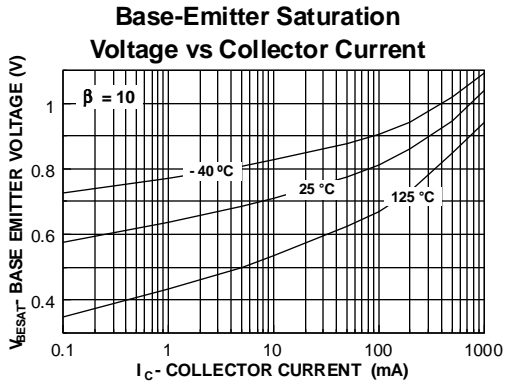

NPN General Purpose Amplifier

(continued)

Typical Characteristics (continued)

Gain Bandwidth Product vs Collector Current

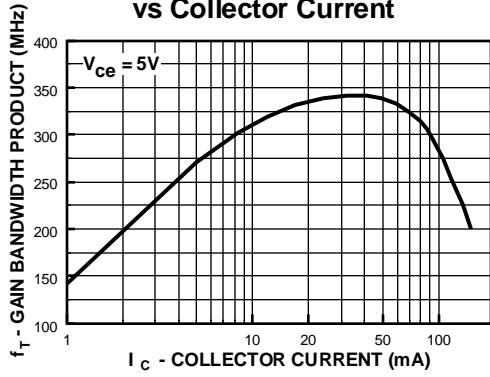

Power Dissipation vs Ambient Temperature

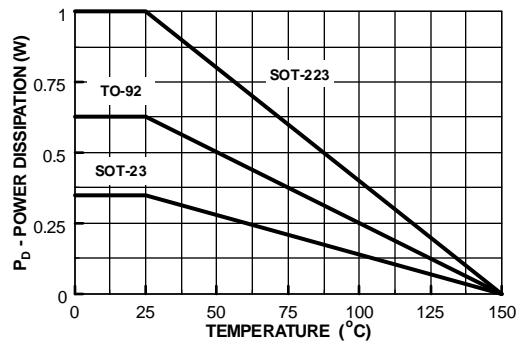

MPSA06 / NMBTA06 / PZTA06