

### GTR Module

### Silicon N Channel IGBT

### High Power Switching Applications

### Motor Control Applications

#### Features

- 6 IGBTs are built into 1 package
- High speed:  $t_f = 0.35\mu\text{s}$  (Max.) ( $I_C = 15\text{A}$ )  
 $t_{rr} = 0.15\mu\text{s}$  (Max.) ( $I_C = 15\text{A}$ )
- Low saturation voltage:  $V_{CE(sat)} = 3.5\text{V}$  (Max.) ( $I_F = 15\text{A}$ )
- Enhancement mode
- The electrodes are isolated from case

#### Maximum Ratings ( $T_c = 25^\circ\text{C}$ )

CHARACTERISTIC	SYMBOL	RATING	UNIT
Collector-Emitter Voltage	$V_{CES}$	600	V
Gate-Emitter Voltage	$V_{GES}$	$\pm 20$	V
Collector Current	DC	$I_C$	15
	1ms	$I_{CP}$	30
Forward Current	DC	$I_F$	15
	1ms	$I_{FM}$	30
Collector Power Dissipation	$P_C$	80	W
Junction Temperature	$T_j$	150	$^\circ\text{C}$
Storage Temperature Range	$T_{stg}$	-40 ~ 125	$^\circ\text{C}$
Isolation Voltage	$V_{isol}$	2500 (AC 1 Minute)	V
Screw Torque	—	3	N ¥ m

Unit in mm

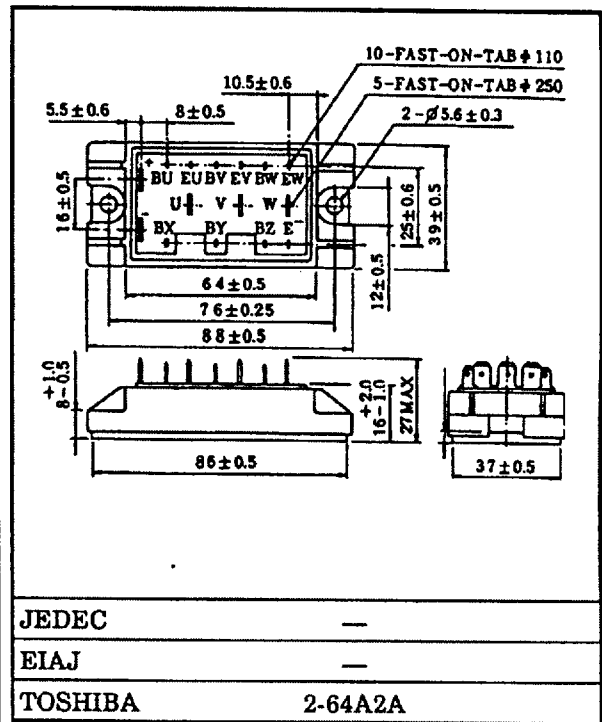

Weight : 152g

Equivalent Circuit

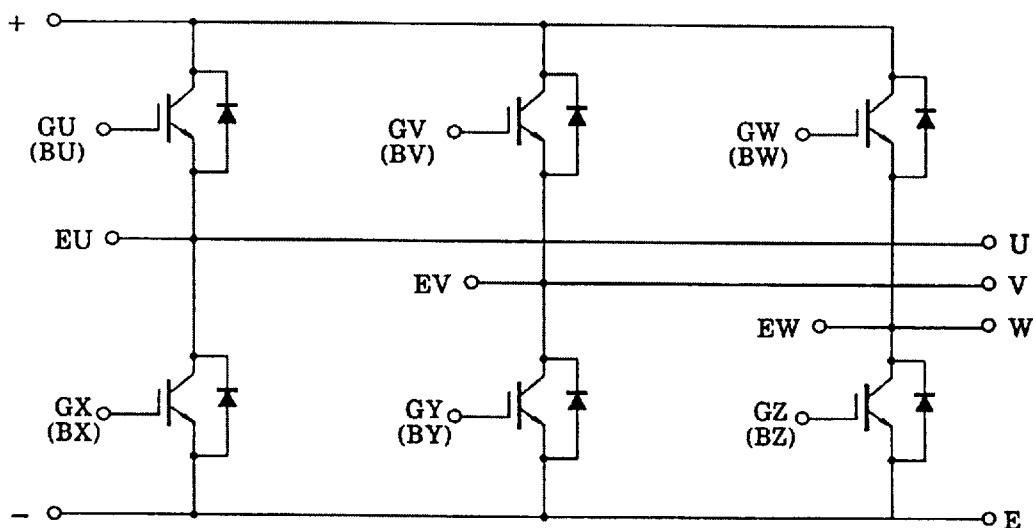

Electrical Characteristics (Tc = 25°C)

CHARACTERISTIC		SYMBOL	TEST CONDITION	MIN.	TYP.	MAX.	UNIT
Gate Leakage Current		$I_{GES}$	$V_{GE} = \pm 20V, V_{CE} = 0$	—	—	$\pm 500$	nA
Collector Cut-off Current		$I_{CES}$	$V_{CE} = 600V, V_{GE} = 0$	—	—	1.0	mA
Collector-Emitter Breakdown Voltage		$V_{(BR) CES}$	$I_C = 10mA, V_{GE} = 0$	600	—	—	V
Gate-Emitter Cut-off Voltage		$V_{GE (OFF)}$	$I_C = 15mA, V_{CE} = 5V$	3.0	—	6.0	V
Collector-Emitter Saturation Voltage		$V_{CE (sat)}$	$I_C = 15A, V_{GE} = 15V$	—	2.7	3.5	V
Input Capacitance		$C_{ies}$	$V_{CE} = 10V, V_{GE} = 0, f = 1MHz$	—	1400	—	pF
Switching Time	Rise Time	$t_r$		—	0.30	0.60	μs
	Turn-on Time	$t_{on}$		—	0.40	0.80	
	Fall Time	$t_f$		—	0.18	0.35	
	Turn-off Time	$t_{off}$		—	0.60	1.00	
Forward Voltage		$V_F$	$I_F = 15A, V_{GE} = 0$	—	2.0	2.7	V
Reverse Recovery Time		$t_{rr}$	$I_F = 15A, V_{GE} = -10V, di/dt = 50A/\mu s$	—	0.08	0.15	μs
Thermal Resistance		$R_{th (j-c)}$	Transistor	—	—	1.56	°C/W
			Diode	—	—	2.80	

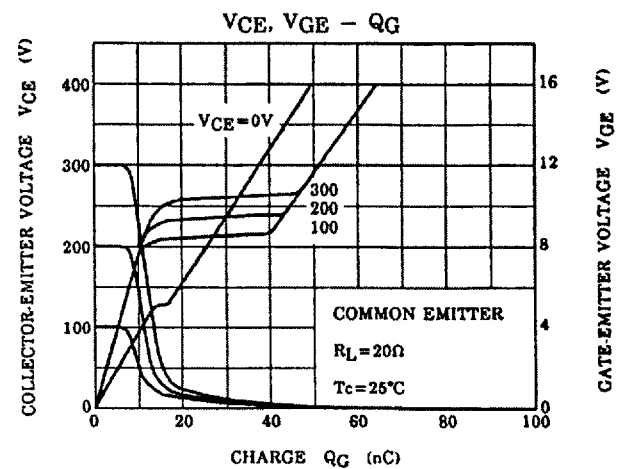
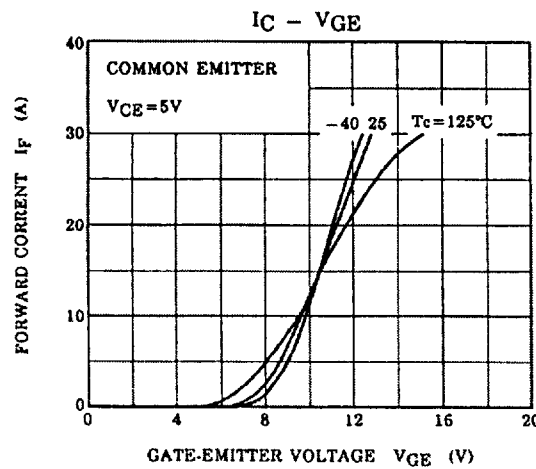
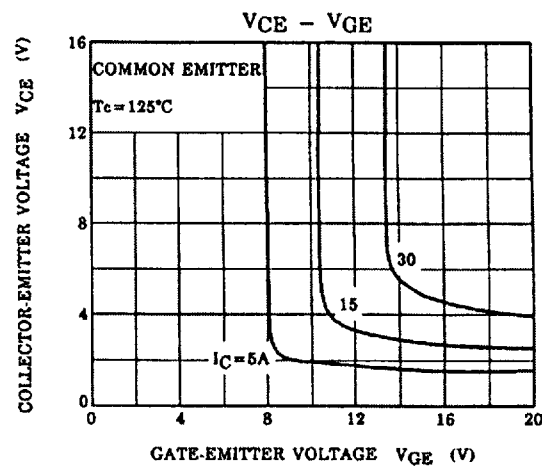
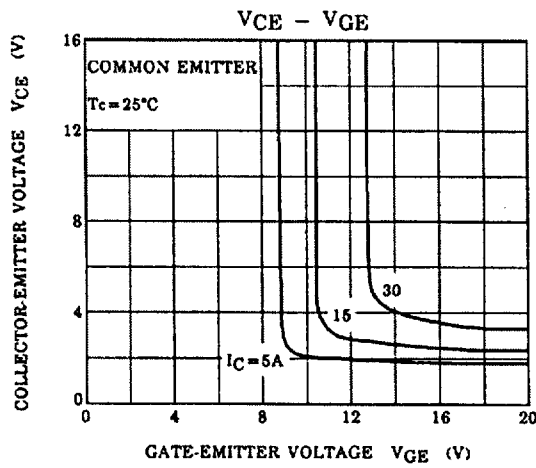
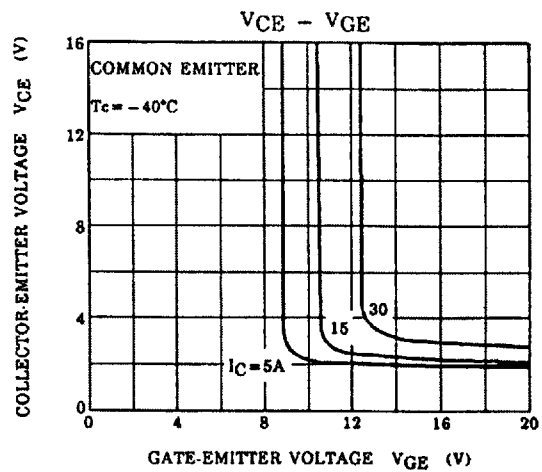
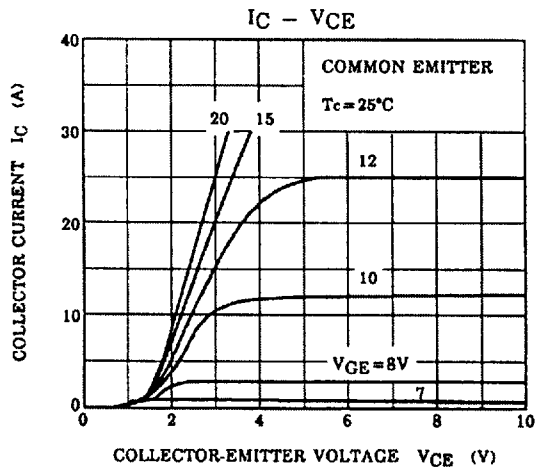

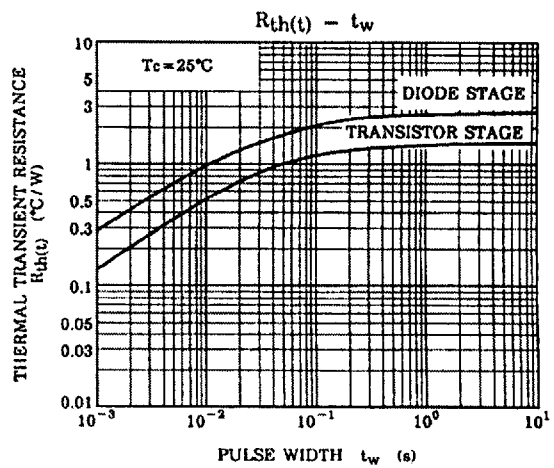
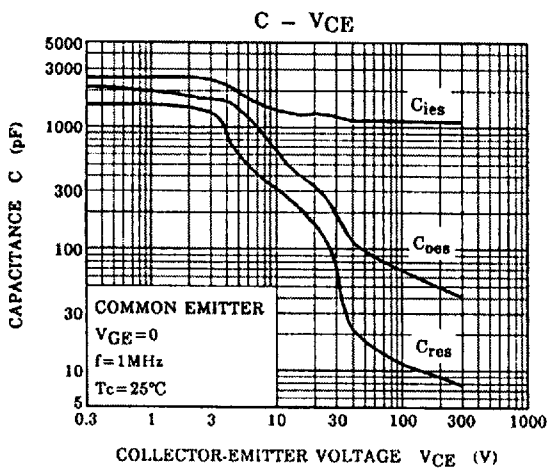
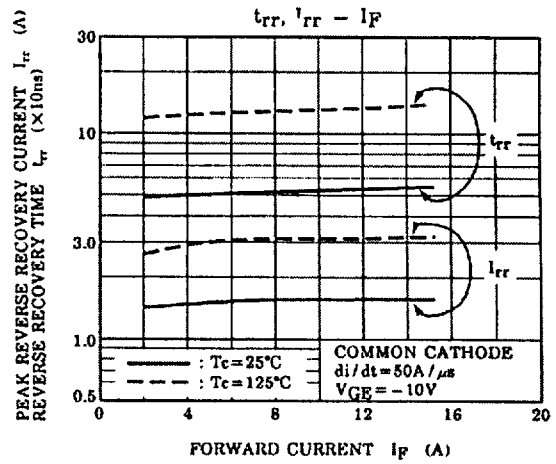
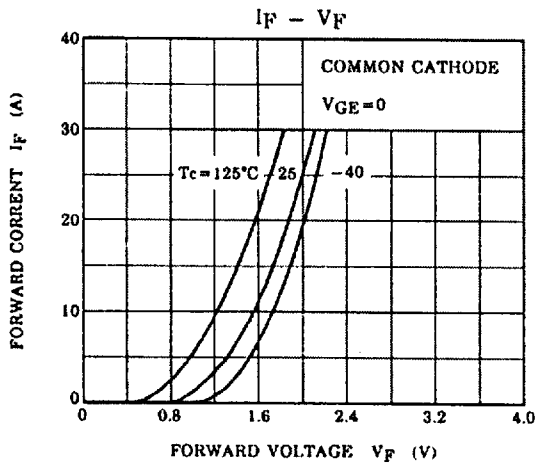
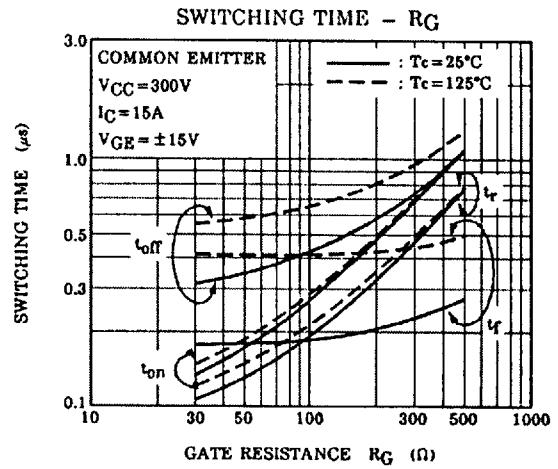
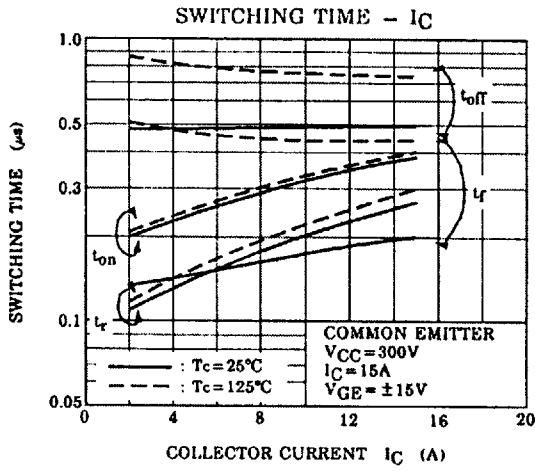

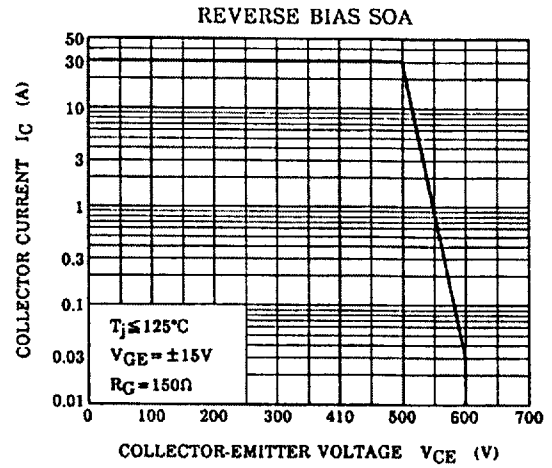
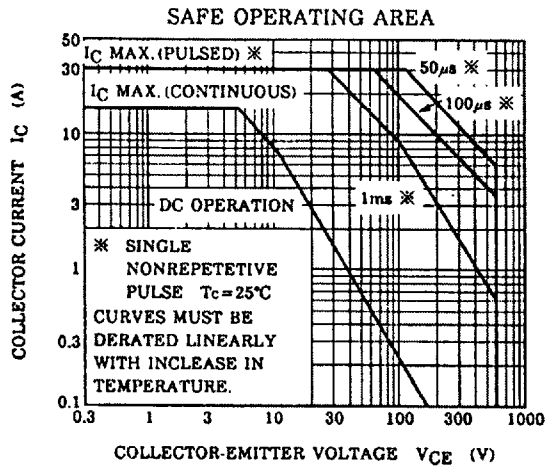

The information contained here is subject to change without notice.

The information contained herein is presented only as guide for the applications of our products. No responsibility is assumed by TOSHIBA for any infringements of patents or other rights of the third parties which may result from its use. No license is granted by implication or otherwise under any patent or patent rights of TOSHIBA or others. These TOSHIBA products are intended for usage in general electronic equipments (office equipment, communication equipment, measuring equipment, domestic electrification, etc.) Please make sure that you consult with us before you use these TOSHIBA products in equipments which require high quality and/or reliability, and in equipments which could have major impact to the welfare of human life (atomic energy control, spaceship, traffic signal, combustion control, all types of safety devices, etc.). TOSHIBA cannot accept liability to any damage which may occur in case these TOSHIBA products were used in the mentioned equipments without prior consultation with TOSHIBA.