

- Advanced Process Technology
- Optimized for 4.5V-7.0V Gate Drive
- Ideal for CPU Core DC-DC Converters
- Fast Switching

Description

These HEXFET Power MOSFETs were designed specifically to meet the demands of CPU core DC-DC converters in the PC environment. Advanced processing techniques combined with an optimized gate oxide design results in a die sized specifically to offer maximum efficiency at minimum cost.

The TO-220 package is universally preferred for all commercial-industrial applications at power dissipation levels to approximately 50 watts. The low thermal resistance and low package cost of the TO-220 contribute to its wide acceptance throughout the industry.

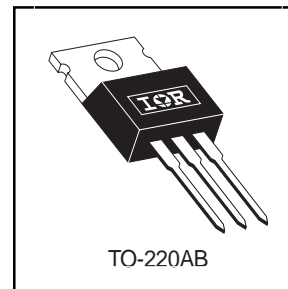
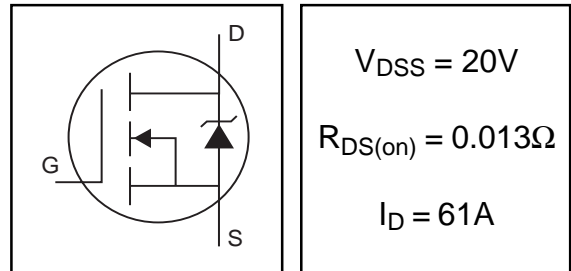

Absolute Maximum Ratings

	Parameter	Max.	Units
$I_D @ T_C = 25^\circ C$	Continuous Drain Current, $V_{GS} @ 4.5V$	61	A
$I_D @ T_C = 100^\circ C$	Continuous Drain Current, $V_{GS} @ 4.5V$	39	
I_{DM}	Pulsed Drain Current ①	240	
$P_D @ T_C = 25^\circ C$	Power Dissipation	89	W
	Linear Derating Factor	0.71	W/°C
V_{GS}	Gate-to-Source Voltage	± 10	V
V_{GSM}	Gate-to-Source Voltage (Start Up Transient, $t_p = 100\mu s$)	14	V
E_{AS}	Single Pulse Avalanche Energy②	220	mJ
I_{AR}	Avalanche Current①	35	A
E_{AR}	Repetitive Avalanche Energy①	8.9	mJ
dv/dt	Peak Diode Recovery dv/dt ③	5.0	V/ns
T_J	Operating Junction and	-55 to + 150	°C
T_{STG}	Storage Temperature Range		
	Soldering Temperature, for 10 seconds		
	Mounting torque, 6-32 or M3 screw	10 lbf•in (1.1N•m)	

Thermal Resistance

	Parameter	Typ.	Max.	Units
$R_{\theta JC}$	Junction-to-Case	—	1.4	°C/W
$R_{\theta CS}$	Case-to-Sink, Flat, Greased Surface	0.50	—	
$R_{\theta JA}$	Junction-to-Ambient	—	62	

Electrical Characteristics @ $T_J = 25^\circ\text{C}$ (unless otherwise specified)

	Parameter	Min.	Typ.	Max.	Units	Conditions
$V_{(BR)DSS}$	Drain-to-Source Breakdown Voltage	20	—	—	V	$V_{GS} = 0V, I_D = 250\mu A$
$\Delta V_{(BR)DSS}/\Delta T_J$	Breakdown Voltage Temp. Coefficient	—	0.016	—	V/ $^\circ\text{C}$	Reference to $25^\circ\text{C}, I_D = 1\text{mA}$
$R_{DS(on)}$	Static Drain-to-Source On-Resistance	—	—	0.015	Ω	$V_{GS} = 4.5V, I_D = 37A$ ④
		—	—	0.013		$V_{GS} = 7.0V, I_D = 37A$ ④
$V_{GS(th)}$	Gate Threshold Voltage	0.70	—	—	V	$V_{DS} = V_{GS}, I_D = 250\mu A$
g_{fs}	Forward Transconductance	36	—	—	S	$V_{DS} = 16V, I_D = 35A$
I_{DSS}	Drain-to-Source Leakage Current	—	—	25	μA	$V_{DS} = 20V, V_{GS} = 0V$
		—	—	250		$V_{DS} = 10V, V_{GS} = 0V, T_J = 150^\circ\text{C}$
I_{GSS}	Gate-to-Source Forward Leakage	—	—	100	nA	$V_{GS} = 10V$
	Gate-to-Source Reverse Leakage	—	—	-100		$V_{GS} = -10V$
Q_g	Total Gate Charge	—	—	58	nC	$I_D = 35A$
Q_{gs}	Gate-to-Source Charge	—	—	14		$V_{DS} = 16V$
Q_{gd}	Gate-to-Drain ("Miller") Charge	—	—	21		$V_{GS} = 4.5V$, See Fig. 6 ④
$t_{d(on)}$	Turn-On Delay Time	—	10	—	ns	$V_{DD} = 10V$
t_r	Rise Time	—	130	—		$I_D = 35A$
$t_{d(off)}$	Turn-Off Delay Time	—	80	—		$R_G = 9.0\Omega, V_{GS} = 4.5V$
t_f	Fall Time	—	110	—		$R_D = 0.28\Omega$, ④
L_D	Internal Drain Inductance	—	4.5	—	nH	Between lead, 6mm (0.25in.) from package and center of die contact
L_S	Internal Source Inductance	—	7.5	—		
C_{iss}	Input Capacitance	—	2500	—	pF	$V_{GS} = 0V$
C_{oss}	Output Capacitance	—	1000	—		$V_{DS} = 15V$
C_{rss}	Reverse Transfer Capacitance	—	360	—		$f = 1.0\text{MHz}$, See Fig. 5

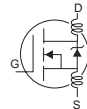

Source-Drain Ratings and Characteristics

	Parameter	Min.	Typ.	Max.	Units	Conditions
I_S	Continuous Source Current (Body Diode)	—	—	61	A	MOSFET symbol showing the integral reverse p-n junction diode.
I_{SM}	Pulsed Source Current (Body Diode) ①	—	—	240		
V_{SD}	Diode Forward Voltage	—	—	1.3	V	$T_J = 25^\circ\text{C}, I_S = 37A, V_{GS} = 0V$ ④
t_{rr}	Reverse Recovery Time	—	59	88	ns	$T_J = 25^\circ\text{C}, I_F = 35A$
Q_{rr}	Reverse Recovery Charge	—	110	160	nC	$di/dt = 100A/\mu s$ ④
t_{on}	Forward Turn-On Time	Intrinsic turn-on time is negligible (turn-on is dominated by L_S+L_D)				

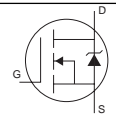

Notes:

- ① Repetitive rating; pulse width limited by max. junction temperature.
- ② Starting $T_J = 25^\circ\text{C}$, $L = 0.36\text{mH}$
 $R_G = 25\Omega, I_{AS} = 35A$.
- ③ $I_{SD} \leq 35A, di/dt \leq 100A/\mu s, V_{DD} \leq V_{(BR)DSS}, T_J \leq 150^\circ\text{C}$
- ④ Pulse width $\leq 300\mu s$; duty cycle $\leq 2\%$.

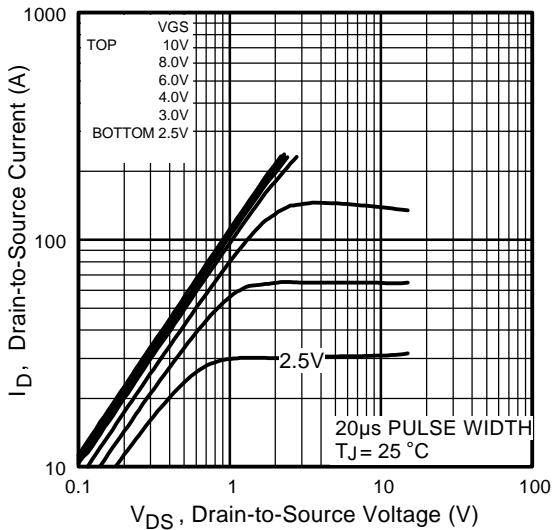

Fig 1. Typical Output Characteristics

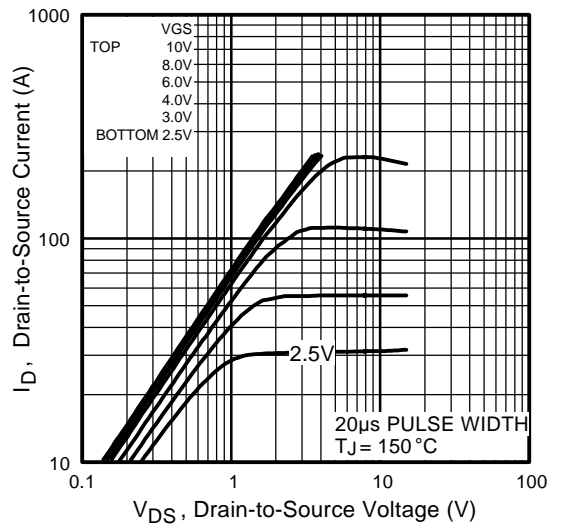

Fig 2. Typical Output Characteristics

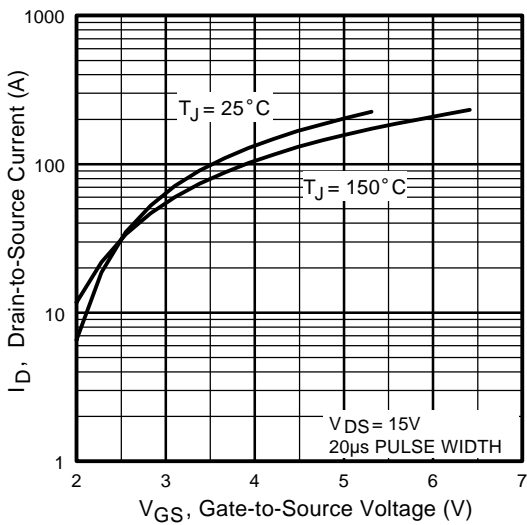

Fig 3. Typical Transfer Characteristics

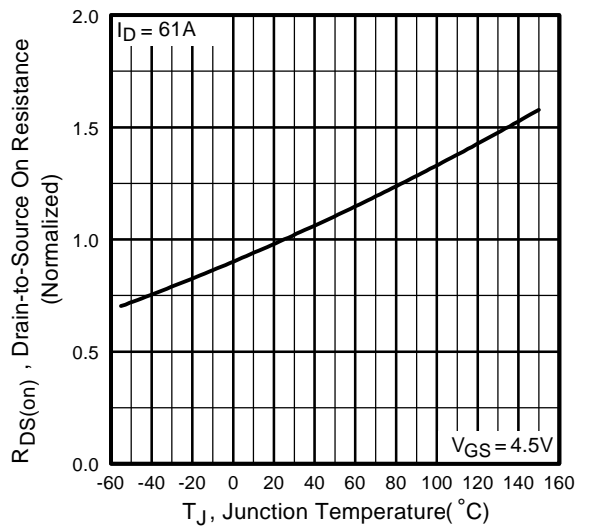

Fig 4. Normalized On-Resistance Vs. Temperature

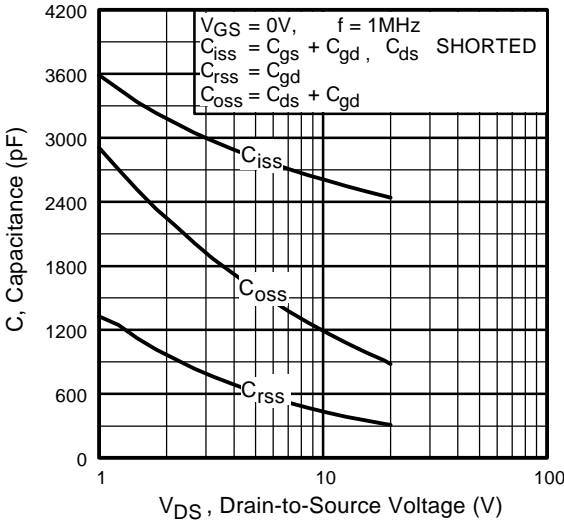

Fig 5. Typical Capacitance Vs. Drain-to-Source Voltage

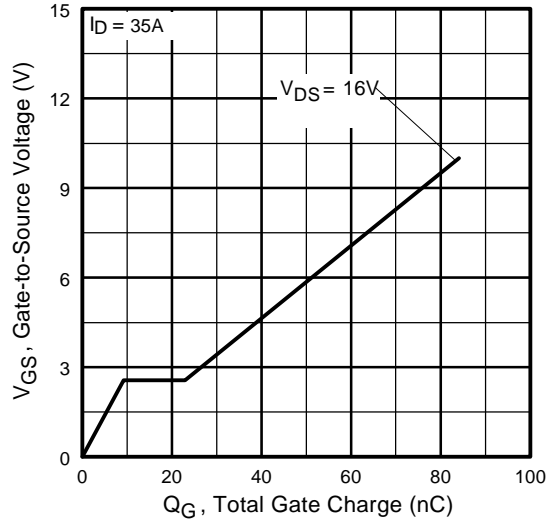

Fig 6. Typical Gate Charge Vs. Gate-to-Source Voltage

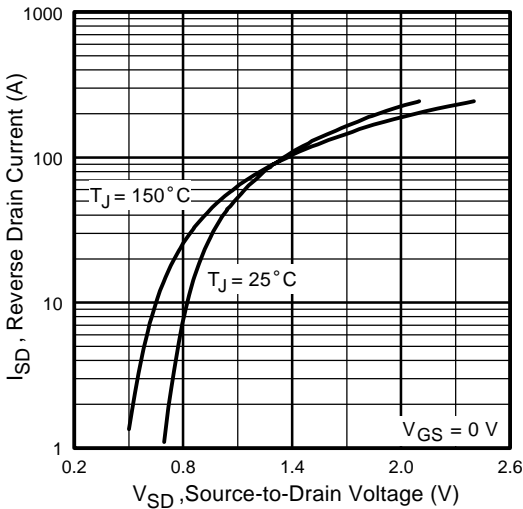

Fig 7. Typical Source-Drain Diode Forward Voltage

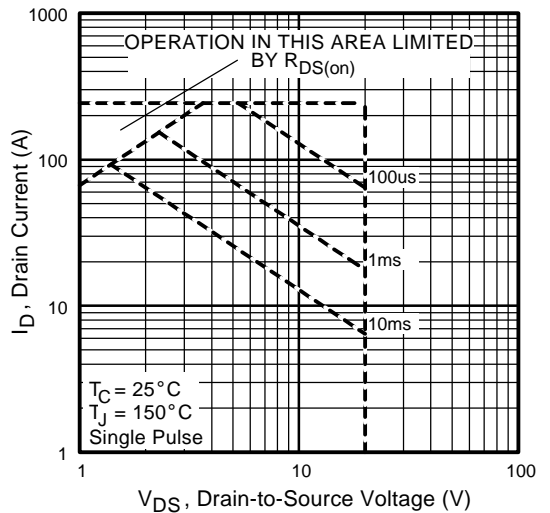

Fig 8. Maximum Safe Operating Area

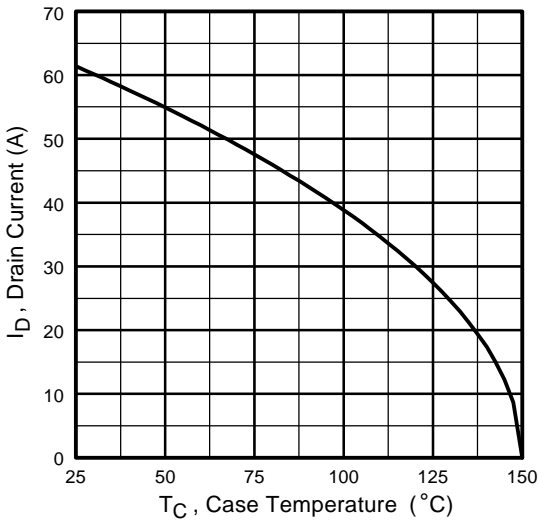

Fig 9. Maximum Drain Current Vs. Case Temperature

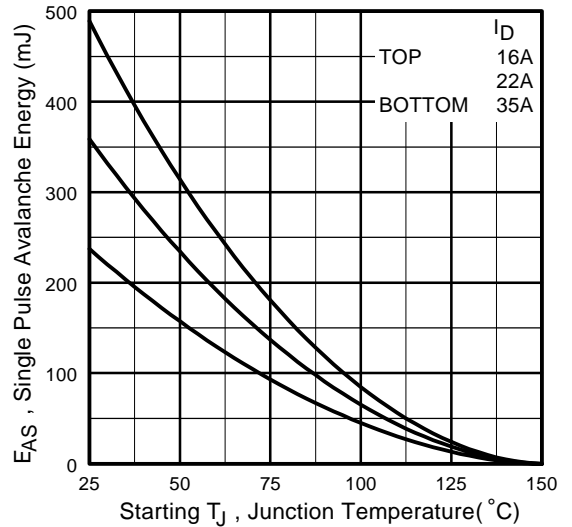

Fig 10. Maximum Avalanche Energy Vs. Drain Current

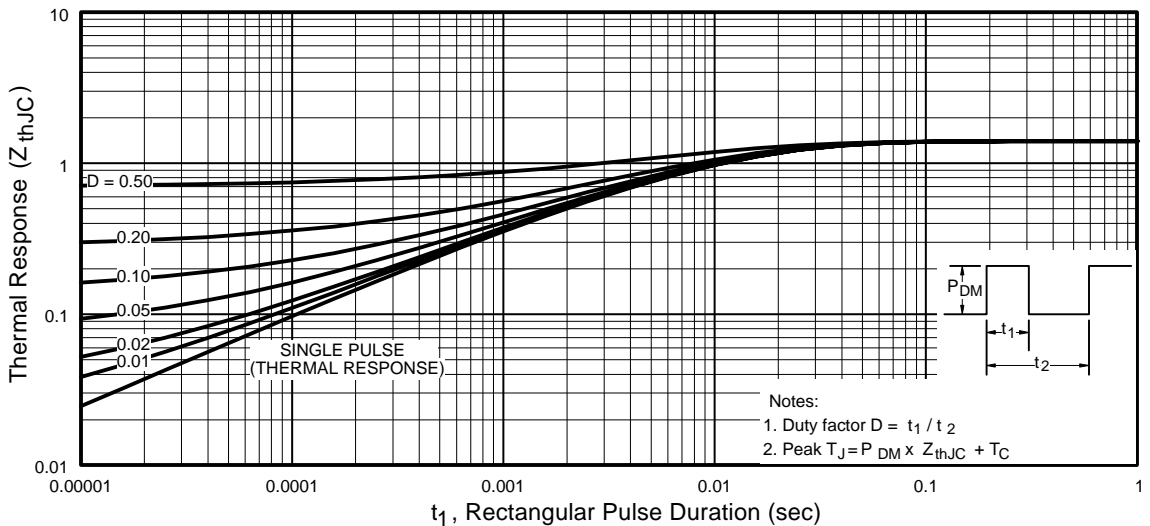

Fig 11. Maximum Effective Transient Thermal Impedance, Junction-to-Case

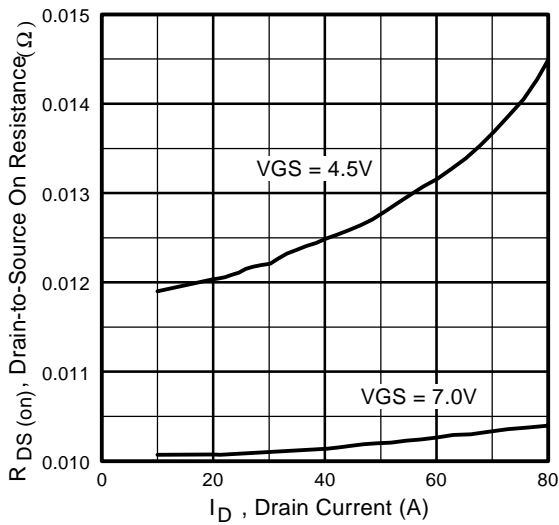

Fig 12. On-Resistance Vs. Drain Current

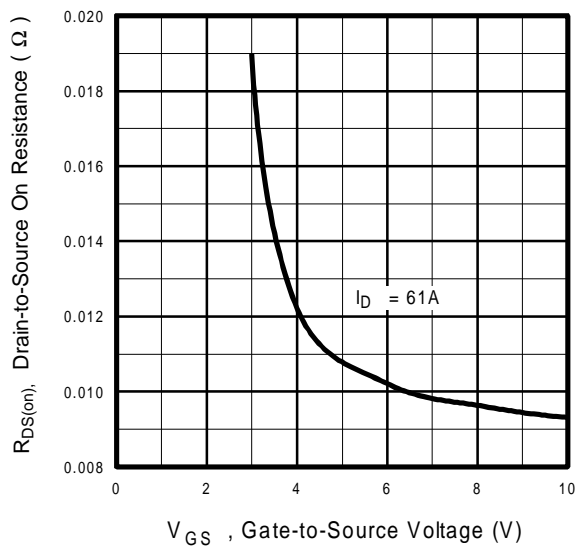
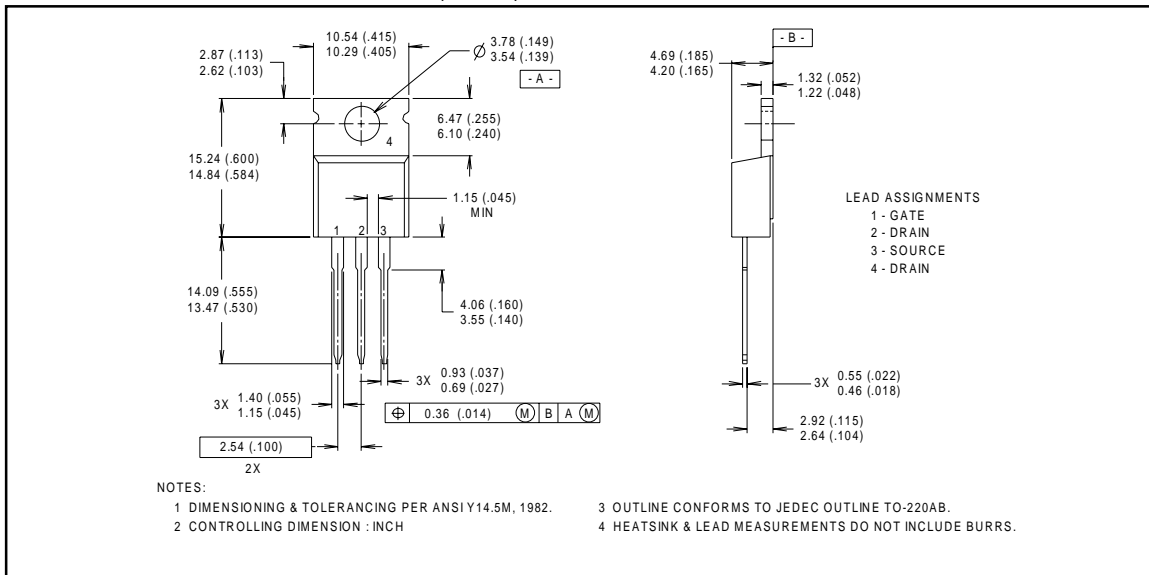

Fig 13. On-Resistance Vs. Gate Voltage

Package Outline

TO-220AB Outline

Dimensions are shown in millimeters (inches)



Part Marking Information

TO-220AB

EXAMPLE : THIS IS AN IRF1010
 WITH ASSEMBLY
 LOT CODE 9B1M

