

QM30DY-H

MEDIUM POWER SWITCHING USE
INSULATED TYPE

QM30DY-H



- **IC** Collector current **30A**
- **V_{CEX}** Collector-emitter voltage **600V**
- **h_{FE}** DC current gain **75**
- **Insulated Type**
- **UL Recognized**

Yellow Card No. E80276 (N)
File No. E80271

APPLICATION

AC motor controllers, UPS, CVCF, DC motor controllers, NC equipment, Welders

OUTLINE DRAWING & CIRCUIT DIAGRAM

Dimensions in mm

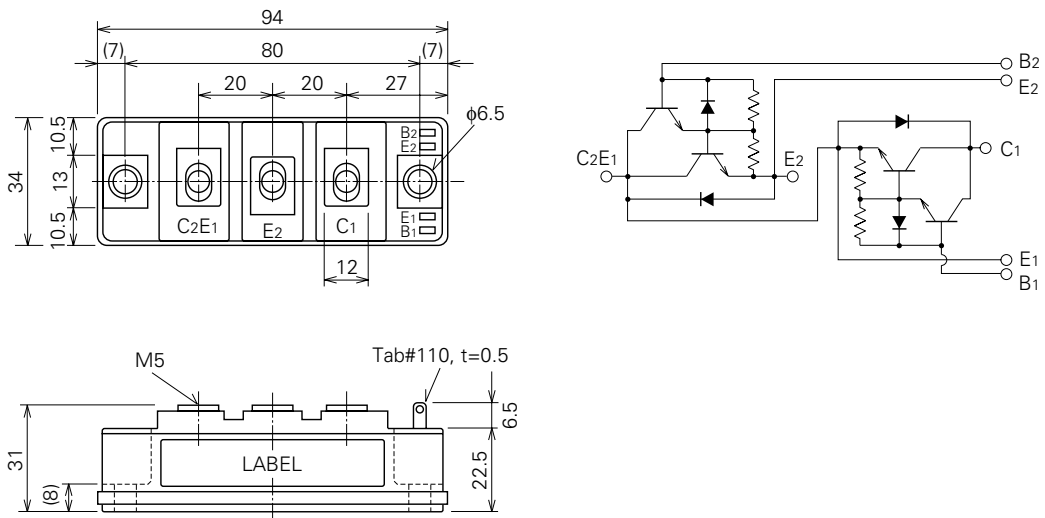

QM30DY-H

**MEDIUM POWER SWITCHING USE
INSULATED TYPE**

ABSOLUTE MAXIMUM RATINGS (Tj=25°C, unless otherwise noted)

Symbol	Parameter	Conditions	Ratings	Unit
VCEX (SUS)	Collector-emitter voltage	IC=1A, VEB=2V	600	V
VCEX	Collector-emitter voltage	VEB=2V	600	V
VCBO	Collector-base voltage	Emitter open	600	V
VEBO	Emitter-base voltage	Collector open	7	V
IC	Collector current	DC	30	A
-IC	Collector reverse current	DC (forward diode current)	30	A
PC	Collector dissipation	Tc=25°C	250	W
IB	Base current	DC	1.8	A
-ICSM	Surge collector reverse current (forward diode current)	Peak value of one cycle of 60Hz (half wave)	300	A
Tj	Junction temperature		-40~+150	°C
Tstg	Storage temperature		-40~+125	°C
Viso	Isolation voltage	Charged part to case, AC for 1 minute	2500	V
—	Mounting torque	Main terminal screw M5	1.47~1.96	N·m
			15~20	kg·cm
		Mounting screw M6	1.96~2.94	N·m
			20~30	kg·cm
—	Weight	Typical value	210	g

ELECTRICAL CHARACTERISTICS (Tj=25°C, unless otherwise noted)

Symbol	Parameter	Test conditions	Limits			Unit
			Min.	Typ.	Max.	
ICEX	Collector cutoff current	VCE=600V, VEB=2V	—	—	1.0	mA
ICBO	Collector cutoff current	VCB=600V, Emitter open	—	—	1.0	mA
IEBO	Emitter cutoff current	VEB=7V	—	—	200	mA
VCE (sat)	Collector-emitter saturation voltage	IC=30A, IB=0.4A	—	—	2.0	V
VBE (sat)	Base-emitter saturation voltage		—	—	2.5	V
-VCEO	Collector-emitter reverse voltage	-IC=30A (diode forward voltage)	—	—	1.85	V
hFE	DC current gain	IC=30A, VCE=2V/5V	75/100	—	—	—
ton	Switching time	VCC=600V, IC=30A, IB1=-IB2=0.6A	—	—	1.5	μs
ts			—	—	12	μs
tf			—	—	3.0	μs
Rth (j-c) Q	Thermal resistance (junction to case)	Transistor part (per 1/2 module)	—	—	0.5	°C/W
Rth (j-c) R		Diode part (per 1/2 module)	—	—	2.0	°C/W
Rth (c-f)	Contact thermal resistance (case to fin)	Conductive grease applied (per 1/2 module)	—	—	0.15	°C/W

QM30DY-H

MEDIUM POWER SWITCHING USE
INSULATED TYPE

PERFORMANCE CURVES

COMMON EMITTER OUTPUT CHARACTERISTICS (TYPICAL)

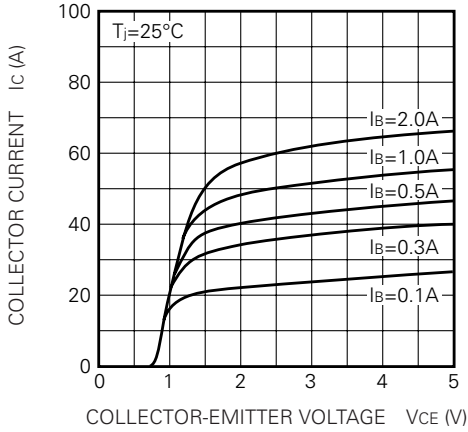

DC CURRENT GAIN VS. COLLECTOR CURRENT (TYPICAL)

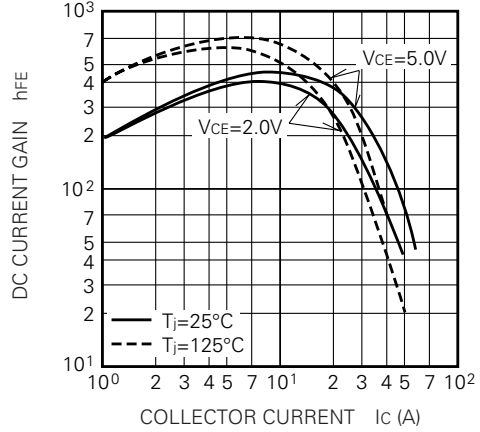

COMMON EMITTER INPUT CHARACTERISTIC (TYPICAL)

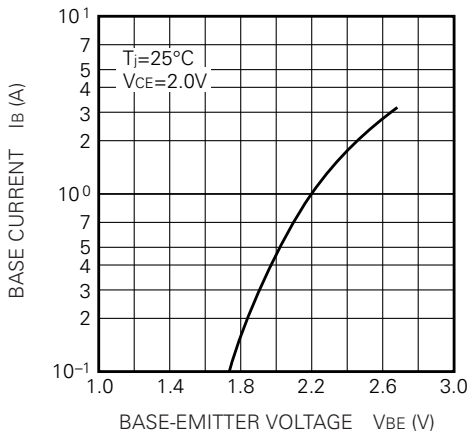

SATURATION VOLTAGE CHARACTERISTICS (TYPICAL)

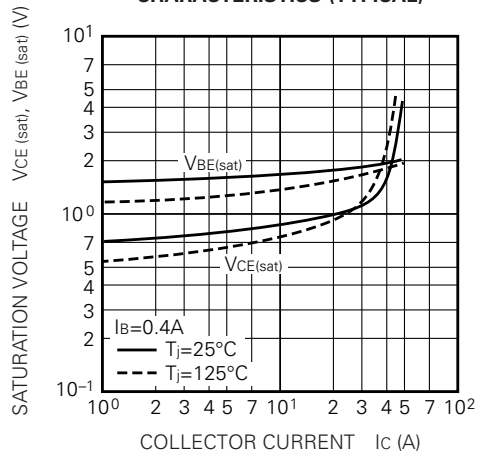

COLLECTOR-EMITTER SATURATION VOLTAGE (TYPICAL)

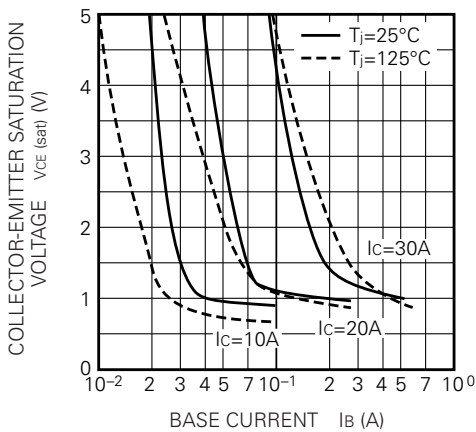

SWITCHING TIME VS. COLLECTOR CURRENT (TYPICAL)

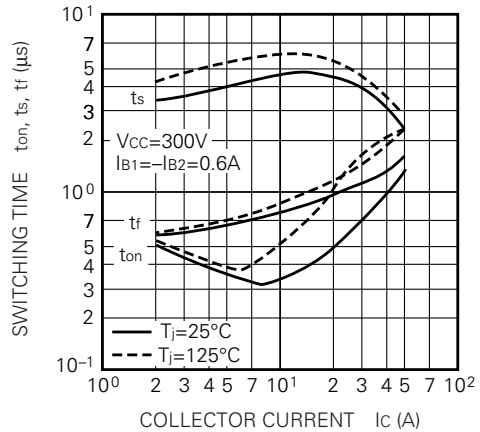

QM30DY-H

MEDIUM POWER SWITCHING USE
INSULATED TYPE

SWITCHING TIME VS. BASE CURRENT (TYPICAL)

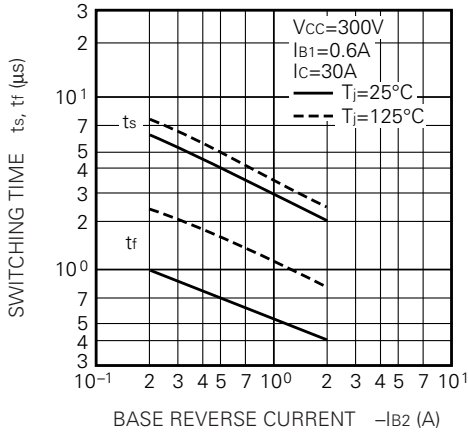

REVERSE BIAS SAFE OPERATING AREA

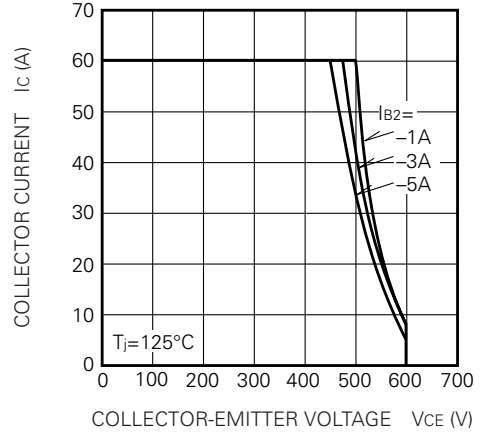

FORWARD BIAS SAFE OPERATING AREA

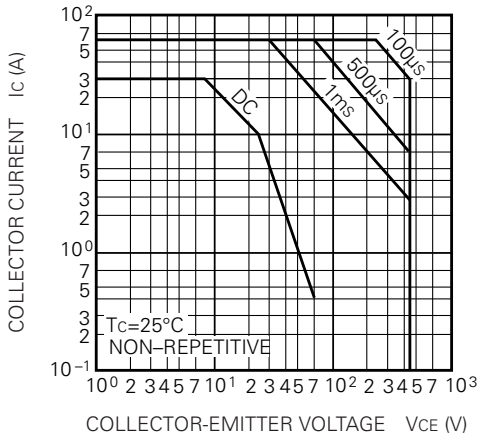

DERATING FACTOR OF F. B. S. O. A.

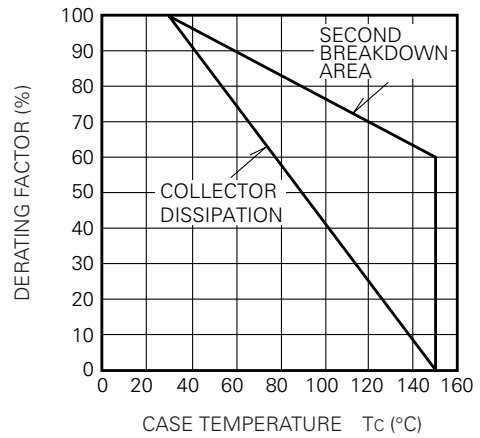

TRANSIENT THERMAL IMPEDANCE CHARACTERISTIC (TRANSISTOR)

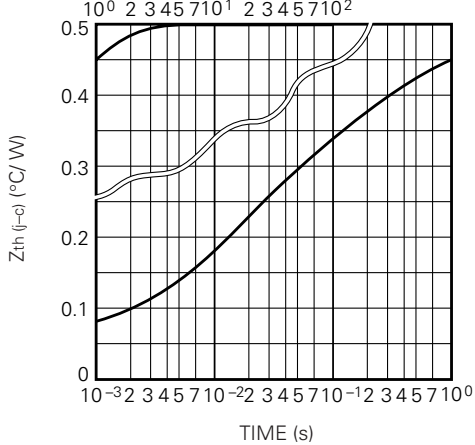

REVERSE COLLECTOR CURRENT VS. COLLECTOR-EMITTER REVERSE VOLTAGE (DIODE FORWARD CHARACTERISTICS) (TYPICAL)

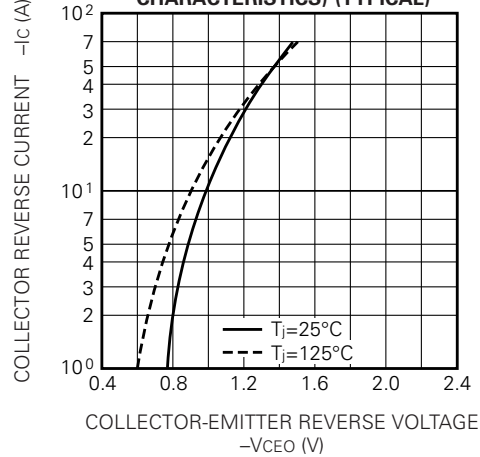

QM30DY-H

MEDIUM POWER SWITCHING USE
INSULATED TYPE

**RATED SURGE COLLECTOR REVERSE CURRENT
(DIODE FORWARD SURGE CURRENT)**

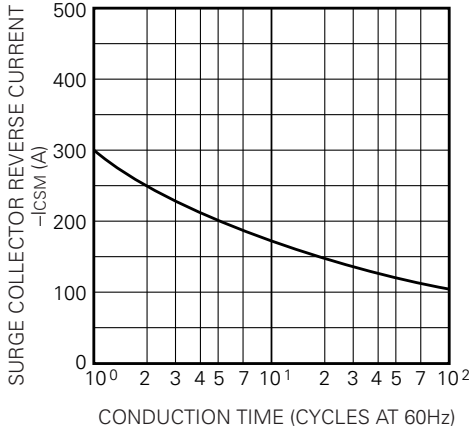

**REVERSE RECOVERY CHARACTERISTICS
OF FREE-WHEEL DIODE (TYPICAL)**

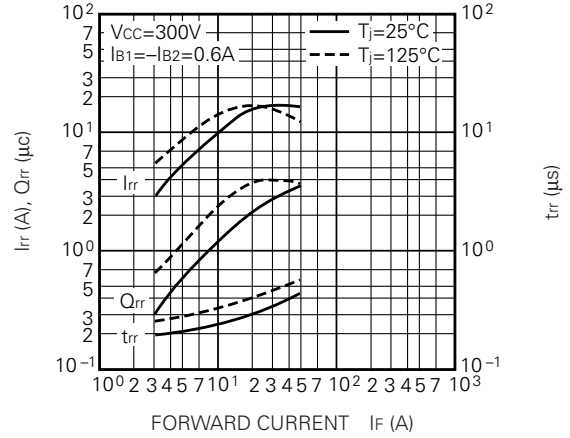

**TRANSIENT THERMAL IMPEDANCE
CHARACTERISTIC (DIODE)**

