

Features

- N channel
- Logic level
- Enhancement mode
- Temperature sensor with thyristor characteristic
- The drain pin is electrically shorted to the tab

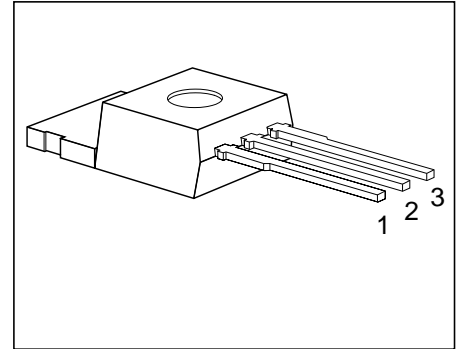

Pin	1	2	3
	G	D	S

Type	V_{DS}	I_D	$R_{DS(on)}$	Package	Ordering Code
BTS 131	50 V	25 A	0.06 Ω	TO-220AB	C67078-A5002-A4

Maximum Ratings

Parameter	Symbol	Values	Unit
Drain-source voltage	V_{DS}	50	V
Drain-gate voltage, $R_{GS} = 20 \text{ k}\Omega$	V_{DGR}	50	
Gate-source voltage	V_{GS}	± 10	
Continuous drain current, $T_C = 25 \text{ }^\circ\text{C}$	I_D	25	A
ISO drain current $T_C = 85 \text{ }^\circ\text{C}$, $V_{GS} = 10 \text{ V}$, $V_{DS} = 0.5 \text{ V}$	I_{D-ISO}	6.5	
Pulsed drain current, $T_C = 25 \text{ }^\circ\text{C}$	$I_{D \text{ puls}}$	100	
Short circuit current, $T_j = -55 \dots +150 \text{ }^\circ\text{C}$	I_{SC}	80	
Short circuit dissipation, $T_j = -55 \dots +150 \text{ }^\circ\text{C}$	P_{SCmax}	1200	W
Power dissipation	P_{tot}	75	
Operating and storage temperature range	T_j, T_{stg}	$-55 \dots +150$	$^\circ\text{C}$
DIN humidity category, DIN 40 040	–	E	–
IEC climatic category, DIN IEC 68-1	–	55/150/56	
Thermal resistance			K/W
Chip-case	$R_{th \text{ JC}}$	≤ 1.67	
Chip-ambient	$R_{th \text{ JA}}$	≤ 75	

Electrical Characteristics

at $T_j = 25\text{ °C}$, unless otherwise specified.

Parameter	Symbol	Values			Unit
		min.	typ.	max.	

Static Characteristics

Drain-source breakdown voltage $V_{GS} = 0, I_D = 0.25\text{ mA}$	$V_{(BR)DSS}$	50	–	–	V
Gate threshold voltage $V_{GS} = V_{DS}, I_D = 1\text{ mA}$	$V_{GS(th)}$	1.5	2.0	2.5	
Zero gate voltage drain current $V_{GS} = 0\text{ V}, V_{DS} = 50\text{ V}$ $T_j = 25\text{ °C}$ $T_j = 125\text{ °C}$	I_{DSS}	– –	1 100	10 300	μA
Gate-source leakage current $V_{GS} = 20\text{ V}, V_{DS} = 0$ $T_j = 25\text{ °C}$ $T_j = 150\text{ °C}$	I_{GSS}	– –	10 2	100 4	nA μA
Drain-source on-state resistance $V_{GS} = 4.5\text{ V}, I_D = 12\text{ A}$	$R_{DS(on)}$	–	0.05	0.06	Ω

Dynamic Characteristics

Forward transconductance $V_{DS} \geq 2 \times I_D \times R_{DS(on)max}, I_D = 12\text{ A}$	g_{fs}	12	17	22	S
Input capacitance $V_{GS} = 0, V_{DS} = 25\text{ V}, f = 1\text{ MHz}$	C_{iss}	800	1050	1400	μF
Output capacitance $V_{GS} = 0, V_{DS} = 25\text{ V}, f = 1\text{ MHz}$	C_{oss}	–	500	750	
Reverse transfer capacitance $V_{GS} = 0, V_{DS} = 25\text{ V}, f = 1\text{ MHz}$	C_{rss}	–	200	300	
Turn-on time t_{on} , ($t_{on} = t_{d(on)} + t_r$) $V_{CC} = 30\text{ V}, V_{GS} = 5\text{ V}, I_D = 3\text{ A}, R_{GS} = 50\text{ }\Omega$	$t_{d(on)}$	–	25	40	ns
	t_r	–	60	90	
Turn-off time t_{off} , ($t_{off} = t_{d(off)} + t_f$) $V_{CC} = 30\text{ V}, V_{GS} = 5\text{ V}, I_D = 3\text{ A}, R_{GS} = 50\text{ }\Omega$	$t_{d(off)}$	–	100	130	
	t_f	–	75	95	

Electrical Characteristics (cont'd)

at $T_j = 25\text{ °C}$, unless otherwise specified.

Parameter	Symbol	Values			Unit
		min.	typ.	max.	

Reverse Diode

Continuous source current	I_S	–	–	25	A
Pulsed source current	I_{SM}	–	–	100	
Diode forward on-voltage $I_F = 50\text{ A}$, $V_{GS} = 0$	V_{SD}	–	1.5	2.0	V
Reverse recovery time $I_F = I_S$, $di_F/dt = 100\text{ A}/\mu\text{s}$, $V_R = 30\text{ V}$	t_{rr}	–	150	–	ns
Reverse recovery charge $I_F = I_S$, $di_F/dt = 100\text{ A}/\mu\text{s}$, $V_R = 30\text{ V}$	Q_{rr}	–	1.0	–	μC

Temperature Sensor

Forward voltage $I_{TS(on)} = 5\text{ mA}$, $T_j = -55 \dots +150\text{ °C}$ Sensor override, $t_p \leq 100\text{ }\mu\text{s}$ $T_j = -55 \dots +160\text{ °C}$	$V_{TS(on)}$	–	1.3	1.4	V
		–	–	10	
Forward current $T_j = -55 \dots +150\text{ °C}$ Sensor override, $t_p \leq 100\text{ }\mu\text{s}$ $T_j = -55 \dots +160\text{ °C}$	$I_{TS(on)}$	–	–	5	mA
		–	–	600	
Holding current, $V_{TS(off)} = 5\text{ V}$, $T_j = 25\text{ °C}$ $T_j = 150\text{ °C}$	I_H	0.05 0.05	0.1 0.2	0.5 0.3	
Switching temperature $V_{TS} = 5\text{ V}$	$T_{TS(on)}$	150	–	–	°C
Turn-off time $V_{TS} = 5\text{ V}$, $I_{TS(on)} = 2\text{ mA}$	t_{off}	0.5	–	2.5	μs

Examples for short-circuit protection

at $T_j = -55 \dots +150 \text{ }^\circ\text{C}$, unless otherwise specified.

Parameter	Symbol	Examples			Unit
		1	2	–	
Drain-source voltage	V_{DS}	15	30	–	V
Gate-source voltage	V_{GS}	6.2	4.1	–	
Short-circuit current	I_{SC}	≤ 80	≤ 37	–	A
Short-circuit dissipation	P_{SC}	1200	1100	–	W
Response time $T_j = 25 \text{ }^\circ\text{C}$, before short circuit	$t_{SC(off)}$	25	25	–	ms

Short-circuit protection $I_{SC} = f(V_{DS})$

Parameter: V_{GS}

Diagram to determine I_{SC} for $T_j = -55 \dots +150 \text{ }^\circ\text{C}$

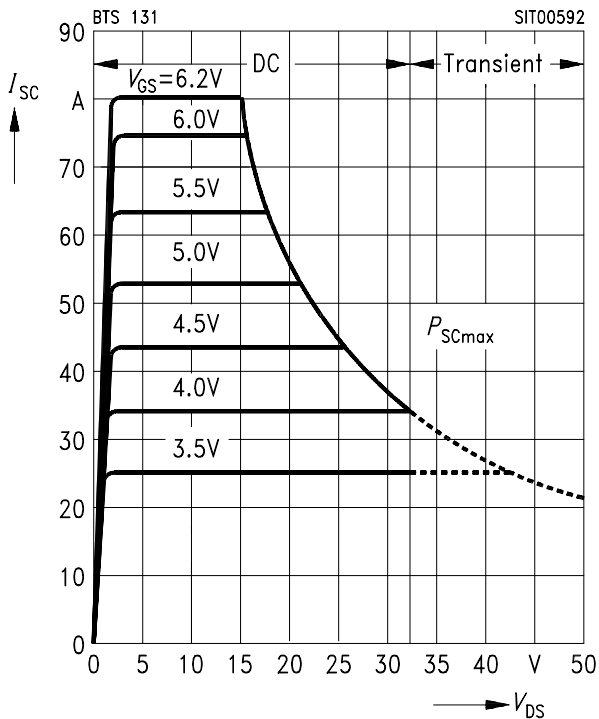

Max. gate voltage $V_{GS(SC)} = f(V_{DS})$

Parameter: $T_j = -55 \dots +150 \text{ }^\circ\text{C}$

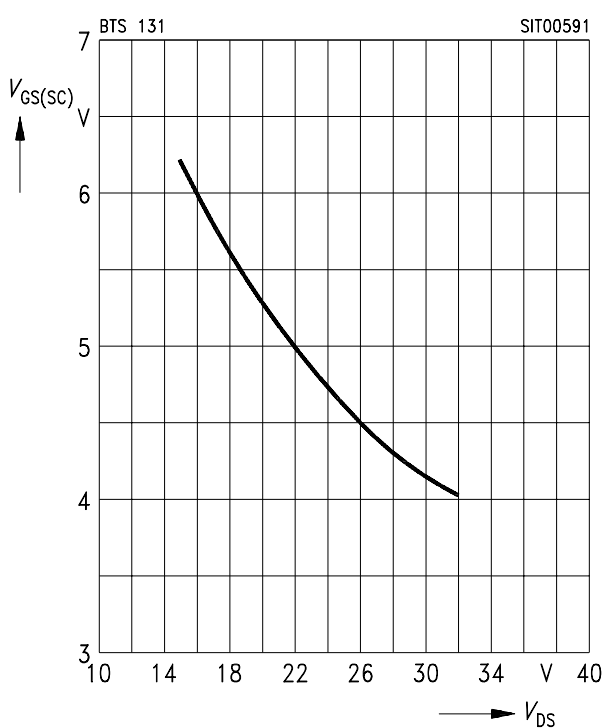

Max. power dissipation $P_{tot} = f(T_C)$

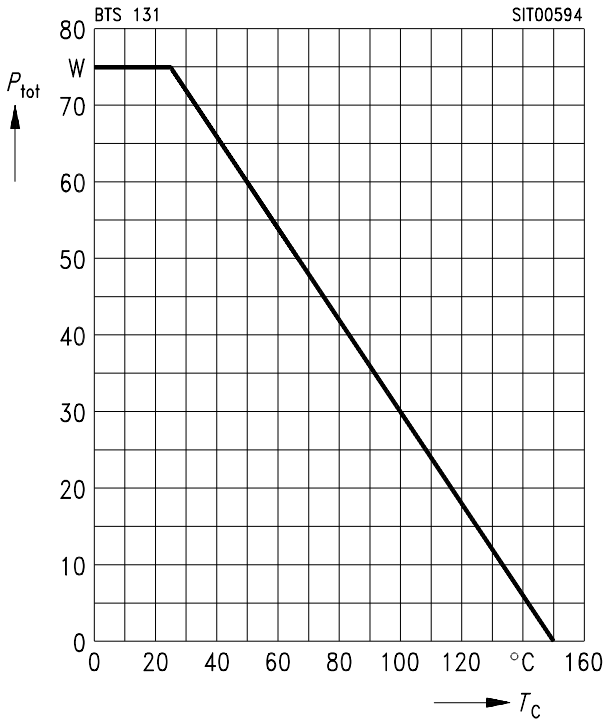

Typ. drain-source on-state resistance $R_{DS(on)} = f(I_D)$

Parameter: V_{GS}

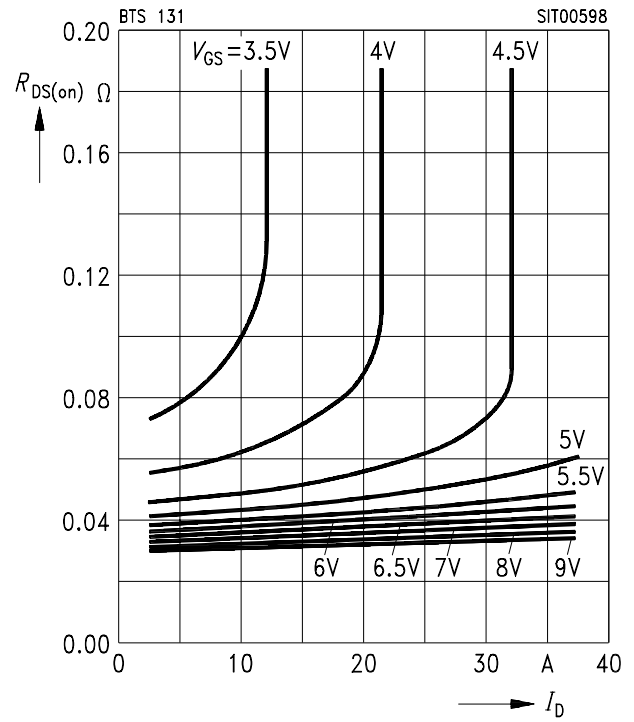

Typical output characteristics $I_D = f(V_{DS})$

Parameter: $t_p = 80 \mu s$

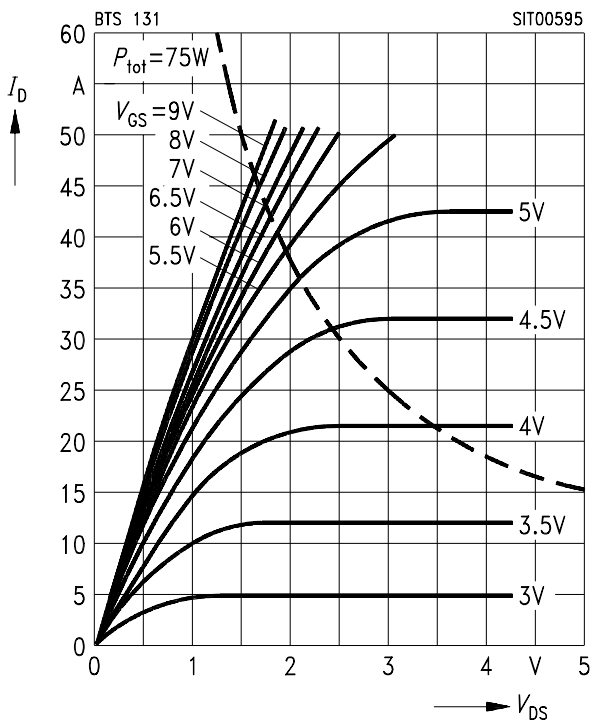

Safe operating area $I_D = f(V_{DS})$

Parameter: $D = 0.01, T_C = 25^\circ C$

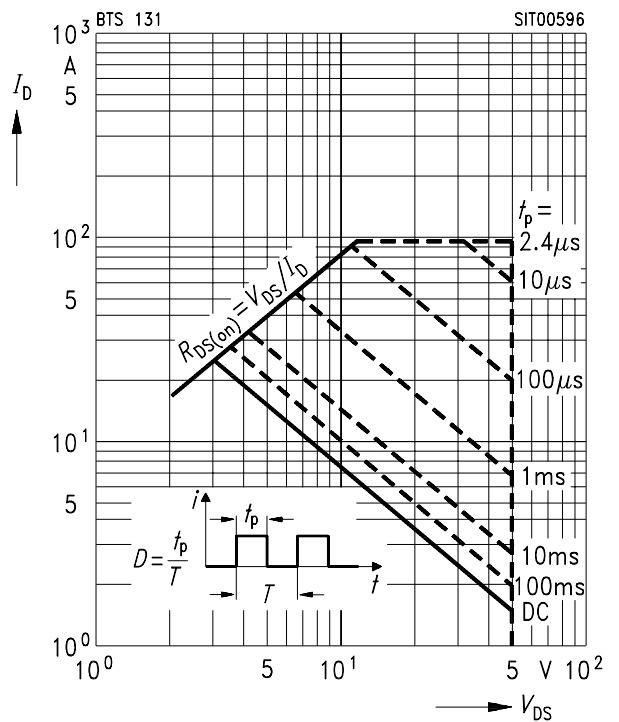

Drain-source on-state resistance

$$R_{DS(on)} = f(T_j)$$

Parameter: $I_D = 12\text{ A}$, $V_{GS} = 4.5\text{ V}$

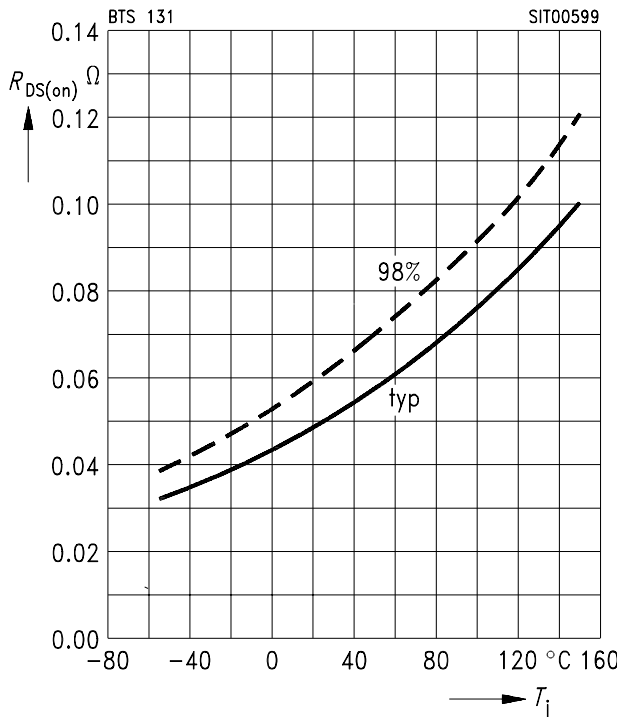

Gate threshold voltage $V_{GS(th)} = f(T_j)$

Parameter: $V_{DS} = V_{GS}$, $I_D = 1\text{ mA}$ (spread)

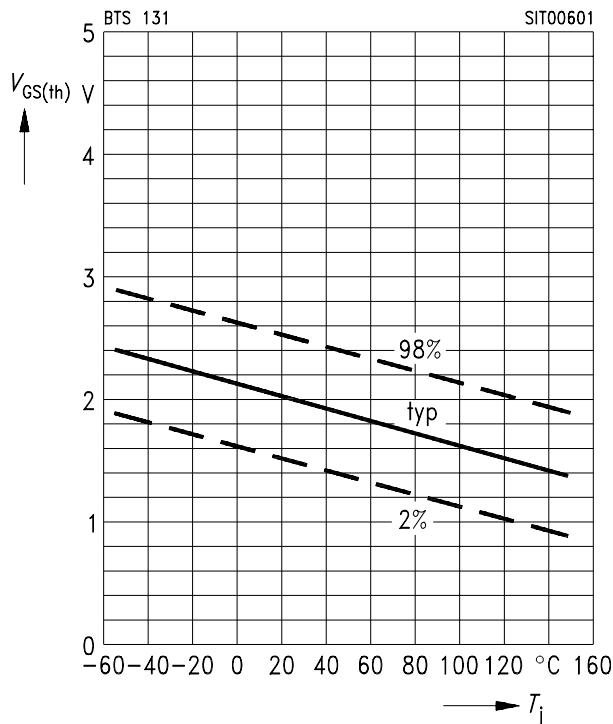

Typ. transfer characteristic

$$I_D = f(V_{GS})$$

Parameter: $t_p = 80\text{ }\mu\text{s}$, $V_{DS} = 25\text{ V}$

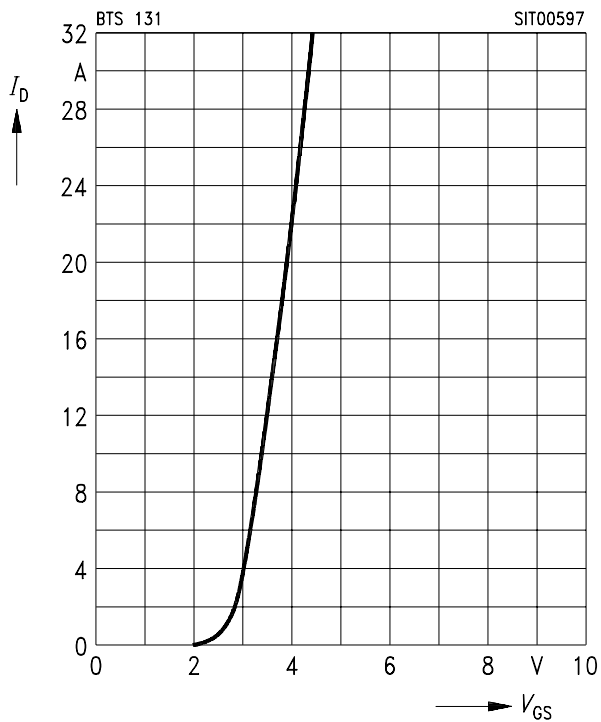

Typ. transconductance $g_{fs} = f(I_D)$

Parameter: $t_p = 80\text{ }\mu\text{s}$, $V_{DS} = 25\text{ V}$

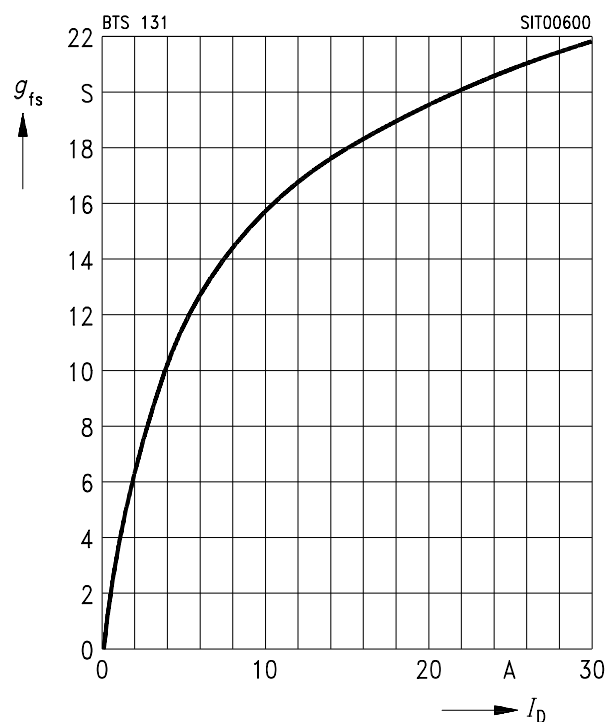

Continuous drain current $I_D = f(T_C)$

Parameter: $V_{GS} \geq 4.5 \text{ V}$

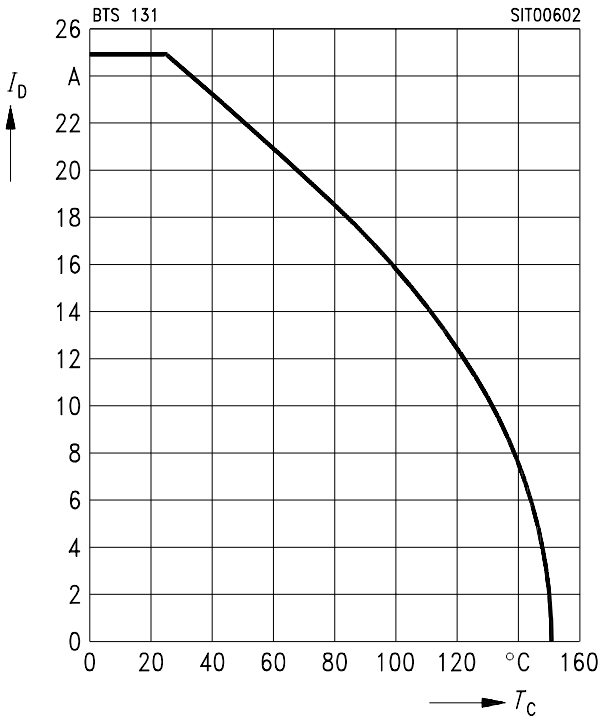

Forward characteristics of reverse diode $I_F = f(V_{SD})$

Parameter: $T_j, t_p = 80 \mu\text{s}$ (spread)

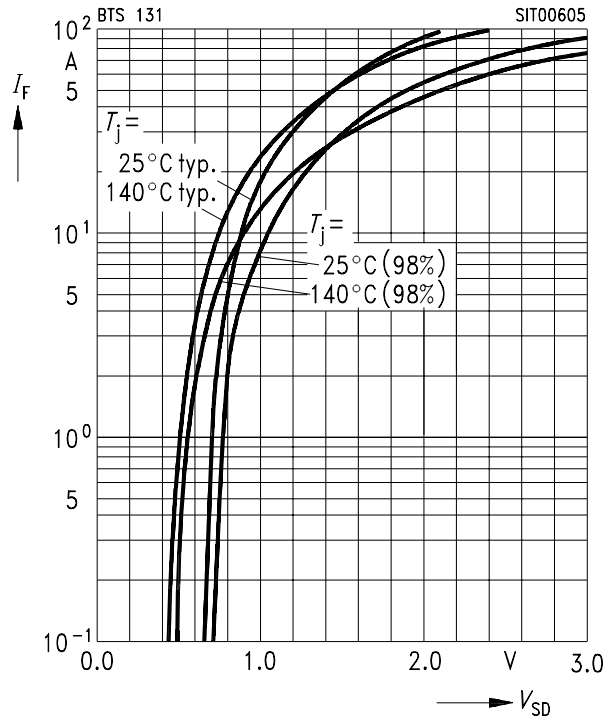

Typ. gate-source leakage current $I_{GSS} = f(T_C)$

Parameter: $V_{GS} = 10 \text{ V}, V_{DS} = 0$

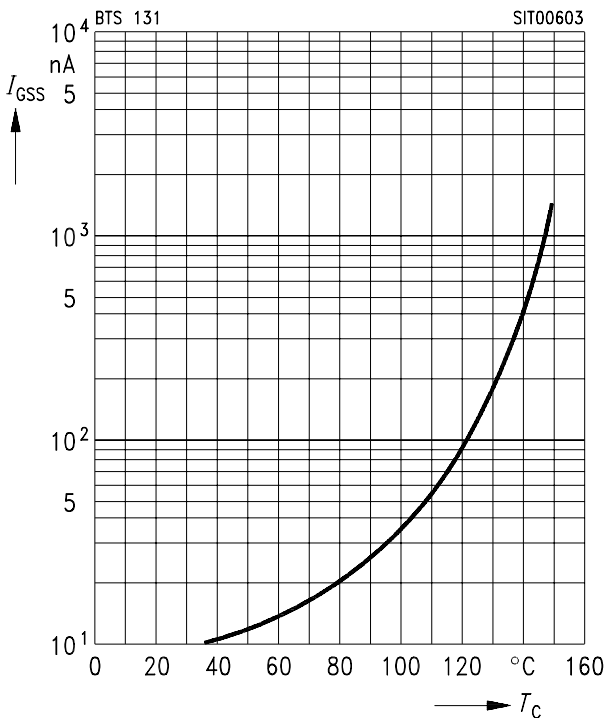

Typ. capacitances $C = f(V_{DS})$

Parameter: $V_{GS} = 0, f = 1 \text{ MHz}$

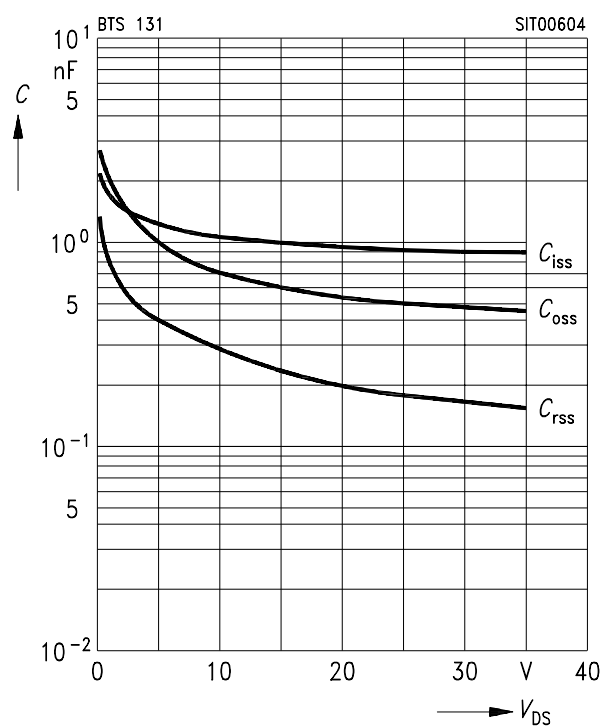

Transient thermal impedance $Z_{thJC} = f(t_p)$
Parameter: $D = t_p/T$

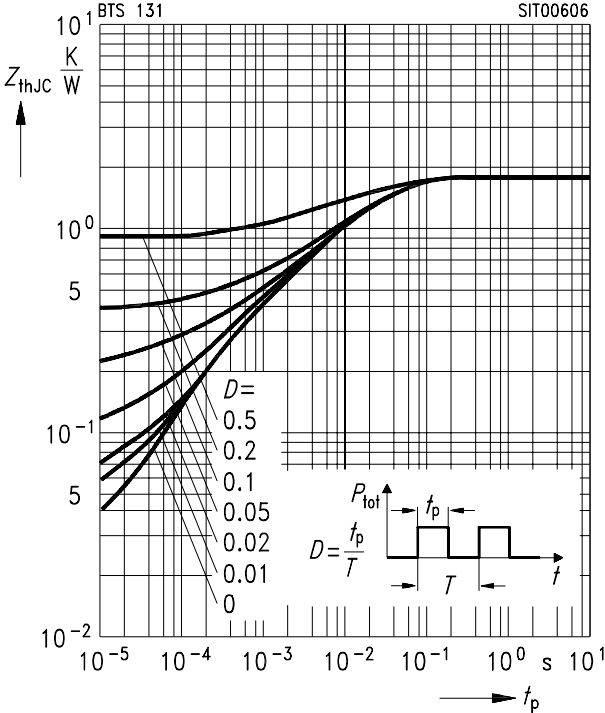

TO 220 AB
Standard

Ordering Code
C67078-A5002-A4

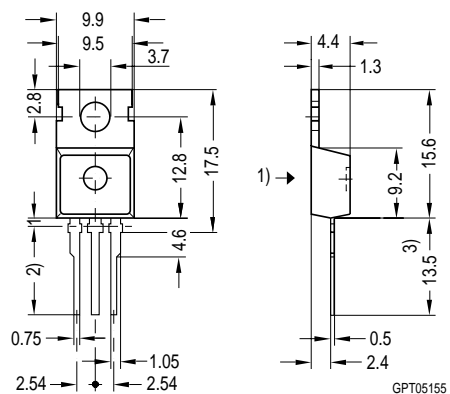

- 1) punch direction, burr max. 0.04
- 2) dip tinning
- 3) max. 14.5 by dip tinning press burr max. 0.05