

### FEATURES

- Wide Operating Range: 50  $\mu$ A–10 mA
- Initial Accuracy:  $\pm 0.1\%$  max
- Temperature Drift:  $\pm 50$  ppm/ $^{\circ}$ C max
- Output Impedance: 0.5  $\Omega$  max
- Wideband Noise (10 Hz–10 kHz): 20  $\mu$ V rms
- Operating Temperature Range:  $-40^{\circ}$ C to  $+85^{\circ}$ C
- High ESD Rating
  - 4 kV Human Body Model
  - 400 V Machine Model
- Compact, Surface-Mount, SOT-23 Package

### GENERAL DESCRIPTION

The AD1580 is a low cost, two-terminal (shunt), precision bandgap reference. It provides an accurate 1.225 V output for input currents between 50  $\mu$ A and 10 mA.

The AD1580's superior accuracy and stability is made possible by the precise matching and thermal tracking of on-chip components. Proprietary curvature correction design techniques have been used to minimize the nonlinearities in the voltage output temperature characteristics. The AD1580 is stable with any value of capacitive load.

The low minimum operating current makes the AD1580 ideal for use in battery powered 3 V or 5 V systems. However, the wide operating current range means that the AD1580 is extremely versatile and suitable for use in a wide variety of high current applications.

The AD1580 is available in two grades, A and B, both of which are provided in an SOT-23 package, the smallest surface mount package available on the market. Both grades are specified over the industrial temperature range of  $-40^{\circ}$ C to  $+85^{\circ}$ C.

### TARGET APPLICATIONS

1. Portable, Battery-Powered Equipment:
  - Cellular Phones, Notebook Computers, PDAs, GPS and DMM.
2. Computer Workstations
  - Suitable for use with a wide range of video RAMDACs.
3. Smart Industrial Transmitters
4. PCMCIA Cards.
5. Automotive.
6. 3 V/5 V 8–12-Bit Data Converters.

### REV. 0

Information furnished by Analog Devices is believed to be accurate and reliable. However, no responsibility is assumed by Analog Devices for its use, nor for any infringements of patents or other rights of third parties which may result from its use. No license is granted by implication or otherwise under any patent or patent rights of Analog Devices.

### PIN CONFIGURATION SOT-23 Package

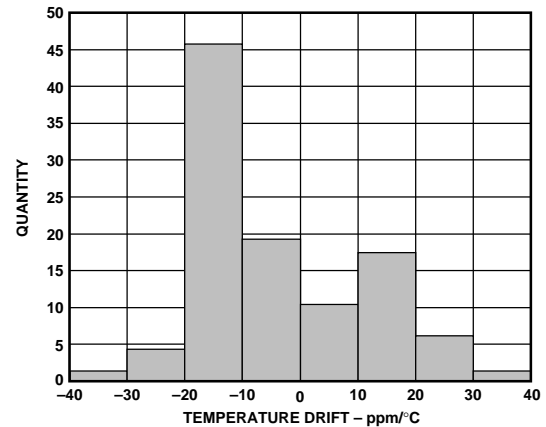
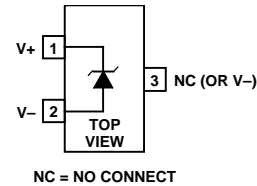

Reverse Voltage Temperature Drift Distribution

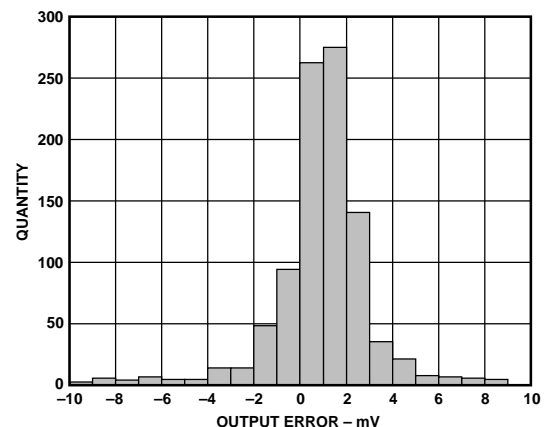

Reverse Voltage Error Distribution

# AD1580—SPECIFICATIONS (@ T<sub>A</sub> = +25°C, I<sub>IN</sub> = 100 μA, unless otherwise noted)

| Model  | AD1580A    |            |             | AD1580B    |            |             | Units            |
|--|------------|------------|-------------|------------|------------|-------------|------------------|
|  | Min        | Typ        | Max         | Min        | Typ        | Max         |                  |
| Reverse Voltage Output   | 1.215      | 1.225      | 1.235       | 1.224      | 1.225      | 1.226       | V                |
| Reverse Voltage Temperature Drift<br>-40°C to +85°C  |            |            | 100         |            |            | 50          | ppm/°C           |
| Minimum Operating Current, T <sub>MIN</sub> to T <sub>MAX</sub>  |            |            | 50          |            |            | 50          | μA               |
| Reverse Voltage Change with Reverse Current<br>50 μA < I <sub>IN</sub> < 10 mA, T <sub>MIN</sub> to T <sub>MAX</sub><br>50 μA < I <sub>IN</sub> < 1 mA, T <sub>MIN</sub> to T <sub>MAX</sub> |            | 2.5<br>0.5 | 5           |            | 2.5<br>0.5 | 5           | mV<br>mV         |
| Dynamic Output Impedance (ΔV <sub>R</sub> /ΔI <sub>R</sub> )<br>I <sub>IN</sub> = 1 mA ±100 μA (f = 120 Hz)  |            | 0.4        | 1           |            | 0.4        | 0.5         | Ω                |
| OUTPUT NOISE<br>RMS Noise Voltage: 10 Hz to 10 kHz<br>Low Frequency Noise Voltage: 0.1 Hz to 10 Hz   |            | 20<br>5    |             |            | 20<br>5    |             | μV rms<br>μV p-p |
| Turn-On Settling Time to 0.1% <sup>1</sup>   |            | 5          |             |            | 5          |             | μs               |
| Output Voltage Hysteresis <sup>2</sup>   |            | 80         |             |            | 80         |             | μV               |
| Temperature Range<br>Specified Performance, T <sub>MIN</sub> to T <sub>MAX</sub><br>Operating Range <sup>3</sup>   | -40<br>-55 |            | +85<br>+125 | -40<br>-55 |            | +85<br>+125 | °C<br>°C         |

## NOTES

<sup>1</sup>Measured with no load capacitor.

<sup>2</sup>Output hysteresis is defined as the change in the +25°C output voltage after a temperature excursion to +85°C and then to -40°C.

<sup>3</sup>The operating temperature range is defined as the temperature extremes at which the device will continue to function. Parts may deviate from their specified performance.

Specifications subject to change without notice.

## ABSOLUTE MAXIMUM RATINGS<sup>1</sup>

|   |                 |
|---|-----------------|
| Reverse Current                         | 25 mA           |
| Forward Current                         | 20 mA           |
| Internal Power Dissipation <sup>2</sup> |                 |
| SOT-23 (RT)                             | 0.3 Watts       |
| Storage Temperature Range               | -65°C to +150°C |
| Operating Temperature Range             |                 |
| AD1580/RT                               | -55°C to +125°C |
| Lead Temperature, Soldering             |                 |
| Vapor Phase (60 sec)                    | +215°C          |
| Infrared (15 sec)                       | +220°C          |
| ESD Susceptibility <sup>3</sup>         |                 |
| Human Body Model                        | 4 kV            |
| Machine Model                           | 400 V           |

## NOTES

<sup>1</sup>Stresses above those listed under “Absolute Maximum Ratings” may cause permanent damage to the device. This is a stress rating only and functional operation of the device at these or any other conditions above those indicated in the operational section of this specification is not implied. Exposure to absolute maximum rating conditions for extended periods may affect device reliability.

<sup>2</sup>Specification is for device in free air at +25°C; SOT-23 Package: θ<sub>JA</sub> = 300°C/Watt.

<sup>3</sup>The human body model is a 100 pF capacitor discharged through 1.5 kΩ. For the machine model, a 200 pF capacitor is discharged directly into the device.

## ORDERING GUIDE

| Model                        | Initial Output Error | Temperature Coefficient | Package Option |
|------------------------------|----------------------|-------------------------|----------------|
| AD1580ART                    | 10 mV                | 100 ppm/°C              | RT             |
| AD1580ART-REEL <sup>1</sup>  | 10 mV                | 100 ppm/°C              | RT             |
| AD1580ART-REEL7 <sup>2</sup> | 10 mV                | 100 ppm/°C              | RT             |
| AD1580BRT                    | 1 mV                 | 50 ppm/°C               | RT             |
| AD1580BRT-REEL <sup>1</sup>  | 1 mV                 | 50 ppm/°C               | RT             |
| AD1580BRT-REEL7 <sup>2</sup> | 1 mV                 | 50 ppm/°C               | RT             |

## NOTES

<sup>1</sup>Provided on a 13-inch reel containing 7,000 pieces.

<sup>2</sup>Provided on a 7-inch reel containing 2,000 pieces.

## PACKAGE BRANDING INFORMATION

Four marking fields identify the device generic, grade, and date of processing. The first field is the product identifier. A “0” identifies the generic as the AD1580. The second field indicates the device grade; “A” or “B.” In the third field a numeral or letter indicates a calendar year; “5” for 1995, “A” for 2001. In the fourth field, letters A-Z represent a two week window within the calendar year; starting with “A” for the first two weeks of January.

## CAUTION

ESD (electrostatic discharge) sensitive device. Electrostatic charges as high as 4000 V readily accumulate on the human body and test equipment and can discharge without detection. Although the AD1580 features proprietary ESD protection circuitry, permanent damage may occur on devices subjected to high energy electrostatic discharges. Therefore, proper ESD precautions are recommended to avoid performance degradation or loss of functionality.



# Typical Performance Characteristics—AD1580

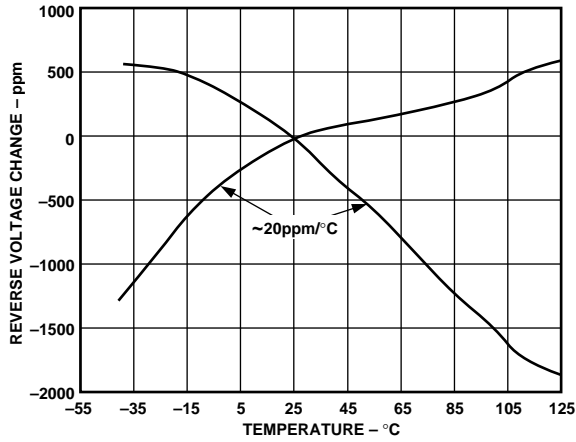

Figure 1. Output Drift for Different Temperature Characteristics

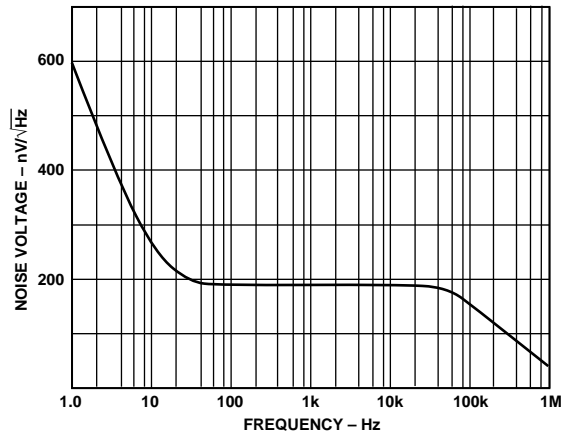

Figure 3. Noise Spectral Density

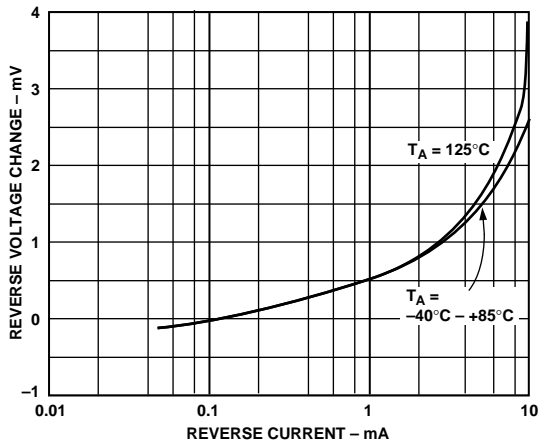

Figure 2. Output Voltage Error vs. Reverse Current

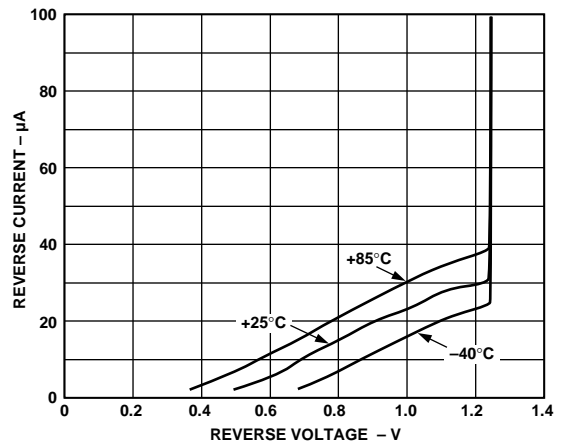

Figure 4. Reverse Current vs. Reverse Voltage

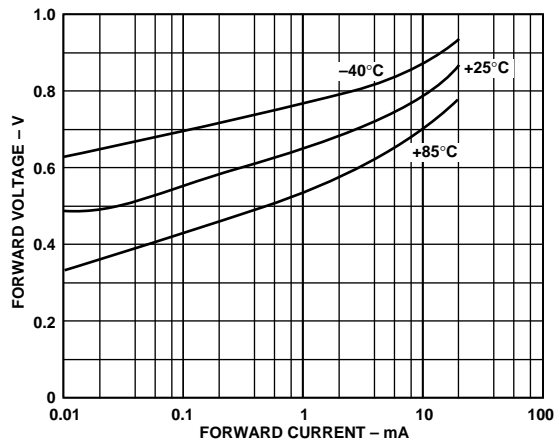

Figure 5. Forward Voltage vs. Forward Current

# AD1580

## THEORY OF OPERATION

The AD1580 uses the “bandgap” concept to produce a stable, low temperature coefficient voltage reference suitable for high accuracy data acquisition components and systems. The device makes use of the underlying physical nature of a silicon transistor base-emitter voltage in the forward-biased operating region. All such transistors have approximately a  $-2\text{ mV}/^\circ\text{C}$  temperature coefficient, unsuitable for use directly as a low TC reference; however, extrapolation of the temperature characteristic of any one of these devices to absolute zero (with collector current proportional to absolute temperature) reveals that its  $V_{BE}$  will go to approximately the silicon bandgap voltage. Thus, if a voltage could be developed with an opposing temperature coefficient to sum with  $V_{BE}$ , a zero TC reference would result. The AD1580 circuit in Figure 6, provides such a compensating voltage,  $V_1$  by driving two transistors at different current densities and amplifying the resultant  $V_{BE}$  difference ( $\Delta V_{BE}$ —which has a positive TC). The sum of  $V_{BE}$  and  $V_1$  provide a stable voltage reference.

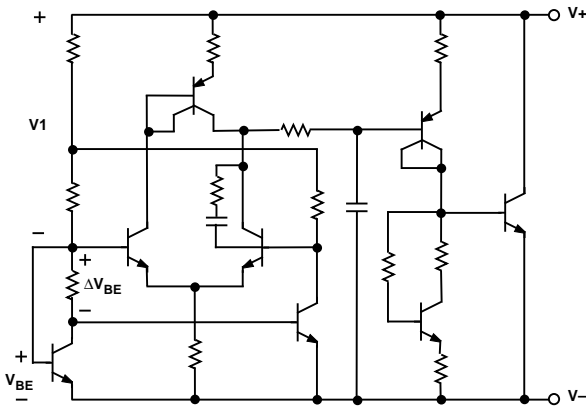

Figure 6. Schematic Diagram

## APPLYING THE AD1580

The AD1580 is simple to use in virtually all applications. To operate the AD1580 as a conventional shunt regulator (Figure 7a), an external series resistor is connected between the supply voltage and the AD1580. For a given supply voltage the series resistor,  $R_S$ , determines the reverse current flowing through the AD1580. The value of  $R_S$  must be chosen to accommodate the expected variations of the supply voltage,  $V_S$ , load current,  $I_L$ , and the AD1580 reverse voltage,  $V_R$ , while maintaining an acceptable reverse current,  $I_R$ , through the AD1580.

The minimum value for  $R_S$  should be chosen when  $V_S$  is at its minimum, and  $I_L$  and  $V_R$  are at their maximum while maintaining the minimum acceptable reverse current.

The value of  $R_S$  should be large enough to limit  $I_R$  to 10 mA when  $V_S$  is at its maximum, and  $I_L$  and  $V_R$  are at their minimum.

The equation for selecting  $R_S$  is as follows:

$$R_S = (V_S - V_R) / (I_R + I_L)$$

Figure 7b shows a typical connection with the AD1580BRT operating at a minimum of  $100\ \mu\text{A}$  that can provide  $\pm 1\ \text{mA}$  to its load, while accommodating  $\pm 10\%$  power supply variations.

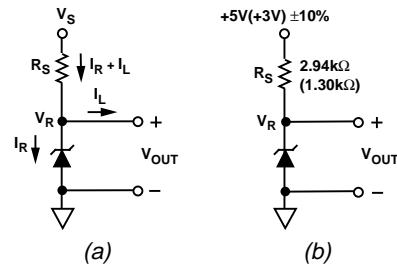

Figure 7. Typical Connection Diagram

## TEMPERATURE PERFORMANCE

The AD1580 is designed for reference applications where stable temperature performance is important. Extensive temperature testing and characterization ensures that the device’s performance is maintained over the specified temperature range.

Some confusion exists in the area of defining and specifying reference voltage error over temperature. Historically, references have been characterized using a maximum deviation per degree centigrade, i.e.,  $50\ \text{ppm}/^\circ\text{C}$ . However, because of nonlinearities in temperature characteristics which originated in standard Zener references (such as “S” type characteristics), most manufacturers now use a maximum limit error band approach to specify devices. This technique involves the measurement of the output at three or more different temperatures to guarantee that the voltage will fall within the given error band. The proprietary curvature correction design techniques used to minimize the AD1580 nonlinearities allow the temperature performance to be guaranteed using the maximum deviation method. This method is of more use to a designer than the one which simply guarantees the maximum error band over the entire temperature change.

Figure 8 shows a typical output voltage drift for the AD1580 and illustrates the methodology. The maximum slope of the two diagonals drawn from the initial output value at  $25^\circ\text{C}$  to the output values at  $85^\circ\text{C}$  and  $-40^\circ\text{C}$  determines the performance grade of the device. For a given grade of the AD1580 the designer can easily determine the maximum total error from the initial tolerance plus temperature variation. For example, the AD1580BRT initial tolerance is  $\pm 1\ \text{mV}$ , a  $\pm 50\ \text{ppm}/^\circ\text{C}$  temperature coefficient corresponds to an error band of  $\pm 4\ \text{mV}$

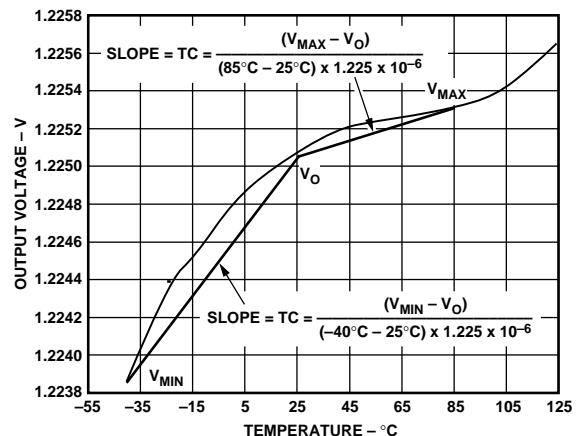

Figure 8. Output Voltage vs. Temperature

$(50 \times 10^{-6} \times 1.225 \text{ V} \times 65^\circ\text{C})$  thus, the unit is guaranteed to be  $1.225 \text{ V} \pm 5 \text{ mV}$  over the operating temperature range.

Duplication of these results requires a combination of high accuracy and stable temperature control in a test system. Evaluation of the AD1580 will produce a curve similar to that in Figures 1 and 8.

**VOLTAGE OUTPUT NONLINEARITY VERSUS TEMPERATURE**

When using a reference with data converters it is important to understand how temperature drift affects the overall converter performance. The nonlinearity of the reference output drift represents additional error that is not easily calibrated out of the system. This characteristic (Figure 9) is generated by normalizing the measured drift characteristic to the end point average drift. The residual drift error of approximately 500 ppm shows that the AD1580 is compatible with systems that require 10-bit accurate temperature performance.

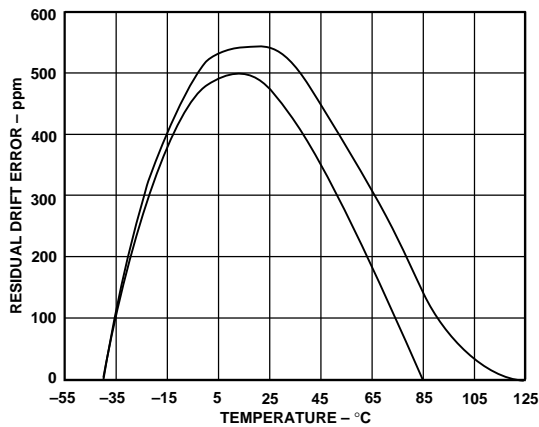

Figure 9. Residual Drift Error

**REVERSE VOLTAGE HYSTERESIS**

A major requirement for high performance industrial equipment manufacturers is a consistent output voltage at nominal temperature following operation over the operating temperature range. This characteristic is generated by measuring the difference between the output voltage at +25°C after operation at +85°C, and the output, also at +25°C after operation at -40°C. Figure 10 displays the hysteresis associated with AD1580. This characteristic exists in all references and has been minimized in the AD1580.

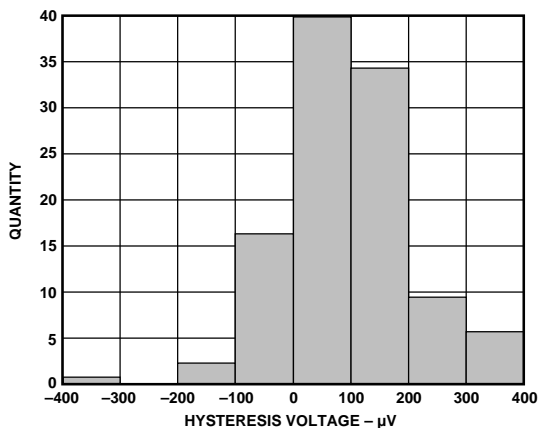

Figure 10. Reverse Voltage Hysteresis Distribution

**OUTPUT IMPEDANCE VERSUS FREQUENCY**

Understanding the effect of the reverse dynamic output impedance in a practical application may be important to successfully apply the AD1580. A voltage divider is formed by the AD1580's output impedance and the external source impedance. When using an external source resistor of about 30 kΩ ( $I_R = 100 \mu\text{A}$ ), 1% of the noise from a 100 kHz switching power supply is developed at the output of the AD1580. Figure 11 shows how a 1 μF load capacitor connected directly across the AD1580 reduces the affect of power supply noise to less than 0.01%.

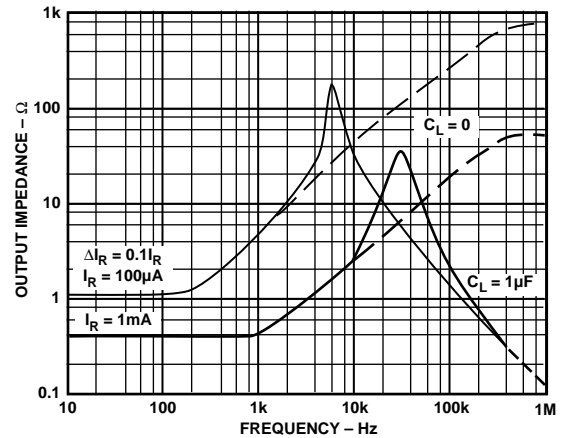

Figure 11. Output Impedance vs. Frequency

**NOISE PERFORMANCE AND REDUCTION**

The noise generated by the AD1580 is typically less than 5 μV p-p over the 0.1 Hz to 10 Hz band. Figure 12 shows the 0.1 Hz to 10 Hz noise of a typical AD1580. Noise in a 10 Hz–10 kHz bandwidth is approximately 20 μV rms (Figure 13a). If further noise reduction is desired, a 1-pole low-pass filter may be added between the output pin and ground. A time constant of 0.2 ms will have a -3 dB point at about 800 Hz, and will reduce the high frequency noise to about 6.5 μV rms, (Figure 13b). A time constant of 960 ms will have a -3 dB point at 165 Hz, and will reduce the high frequency noise to about 2.9 μV rms (Figure 13c).

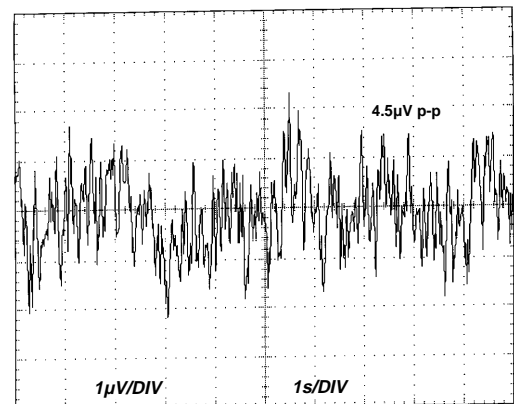

Figure 12. 0.1 Hz–10 Hz Voltage Noise

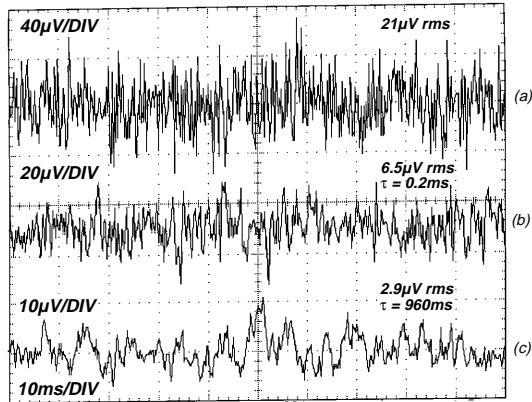

Figure 13. Total RMS Noise

**TURN-ON TIME**

Many low power instrument manufacturers are becoming increasingly concerned with the turn-on characteristics of components being used in their systems. Fast turn-on components often enable the end user to keep power off when not needed, and yet respond quickly when the power is turned on for operation. Figure 14a displays the turn-on characteristic of the AD1580. Upon application of power (cold start), the time required for the output voltage to reach its final value within a specified error is the turn-on settling time. Two components normally associated with this are: time for active circuits to settle and time for thermal gradients on the chip to stabilize. This characteristic is generated from cold-start operation and represents the true turn-on waveform after power up. Figure 15 shows both the coarse and fine turn-on settling characteristics of the device; the total settling time to within 1.0 mV is about 6 µs, and there is no long thermal tail when the horizontal scale is expanded to 2 ms/div.

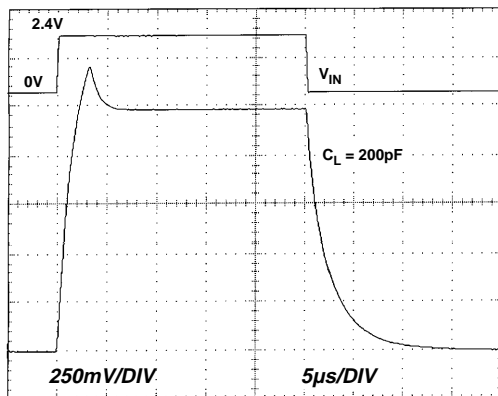

Figure 14a. Response Time

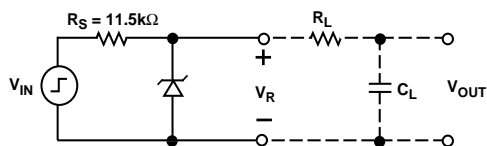

Figure 14b. Turn-On, Settling, and Transient Test Circuit

Output turn-on time is modified when an external noise reduction filter is used. When present, the time constant of the filter will dominate overall settling.

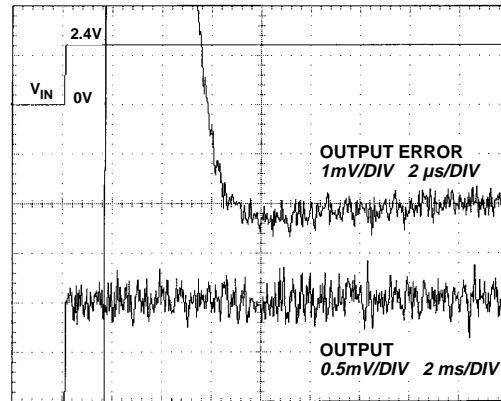

Figure 15. Turn-On Settling

**TRANSIENT RESPONSE**

Many A/D and D/A converters present transient current loads to the reference, and poor reference response can degrade the converter's performance.

Figure 16 displays both the coarse and fine settling characteristics of the device to load transients of  $\pm 50 \mu\text{A}$ .

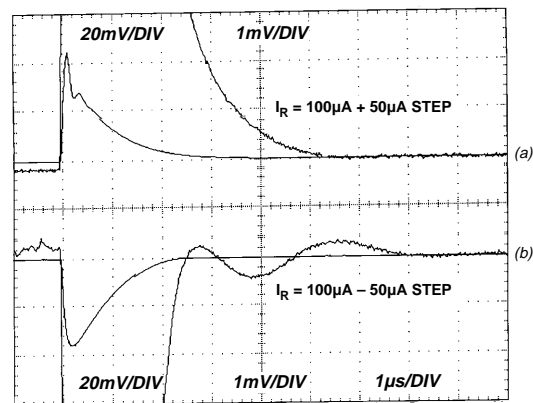

Figure 16. Transient Settling

Figure 16a shows the settling characteristics of the device for an increased reverse current of  $50 \mu\text{A}$ . Figure 16b shows the response when the reverse current is decreased by  $50 \mu\text{A}$ . The transients settle to 1 mV in about 3 µs.

Attempts to drive a large capacitive load (in excess of 1,000 pF) may result in ringing, as shown in the step response photo (Figure 17). This is due to the additional poles formed by the load capacitance and the output impedance of the reference. A recommended method of driving capacitive loads of this magnitude is shown in Figure 14b. A resistor isolates the capacitive load from the output stage, while the capacitor provides a single pole low-pass filter and lowers the output noise.

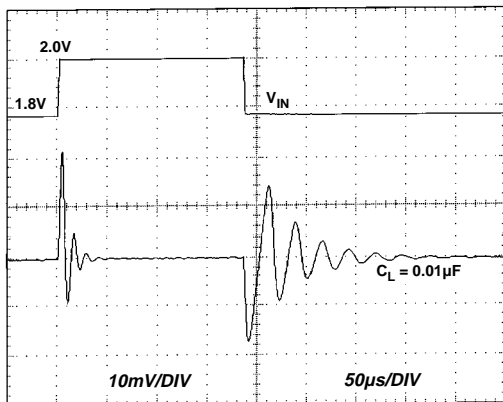

Figure 17. Transient Response with Capacitive Load

## PRECISION MICROPOWER LOW DROPOUT REFERENCE

The circuit in Figure 18 provides an ideal solution for making a stable voltage reference with low standby power consumption, low input/output dropout capability, and minimum noise output. The amplifier both buffers and optionally scales up the AD1580 output voltage,  $V_R$ . Output voltages as high as 2.1 V can supply 1 mA of load current. A one-pole filter connected between the AD1580 and the OP193 input may be used to achieve low output noise. The nominal quiescent power consumption is a mere 200  $\mu$ W.

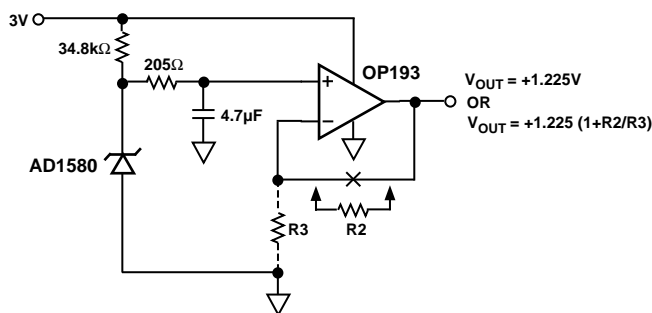

Figure 18. Micropower Buffered Reference

## USING THE AD1580 WITH 3 V DATA CONVERTERS

The AD1580's low output drift (50 ppm/ $^{\circ}$ C) and compact sub-miniature SOT-23 package makes it ideally suited for today's high performance converters in space critical applications.

One family of ADCs that the AD1580 is well suited for is the AD7714-3 and AD7715-3. The AD7714/AD7715 are charge-balancing (sigma-delta) A/D converters with on-chip digital filtering intended for the measurement of wide dynamic range, low frequency signals such as those representing chemical, physical or biological processes. Figure 19 shows the AD1580 connected to the AD7714/AD7715 for 3 V operation.

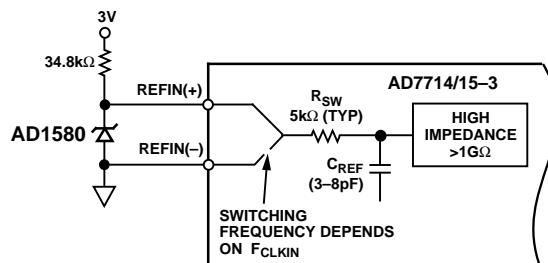

Figure 19. Reference Circuit for the AD7714/AD7715-3

The AD1580 is ideal for creating the reference level to use with 12-bit multiplying DACs such as the AD7943, AD7945, and AD7948. In the single supply bias mode (Figure 20), the impedance seen looking into the  $I_{OUT2}$  terminal changes with DAC code. If the AD1580 drives  $I_{OUT2}$  and AGND directly, less than 0.2 LSBs of additional linearity error will result. The buffer amp eliminates any linearity degradation that could result from variations in the reference level.

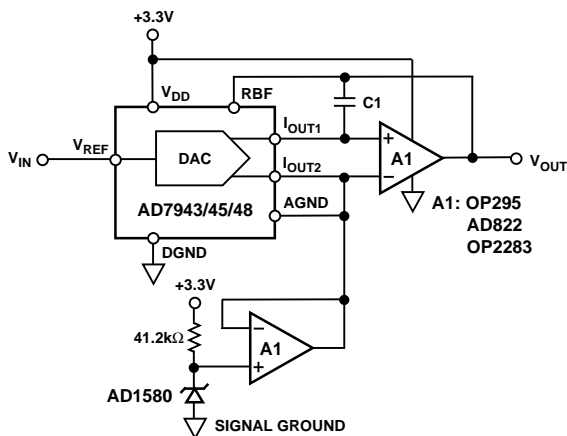
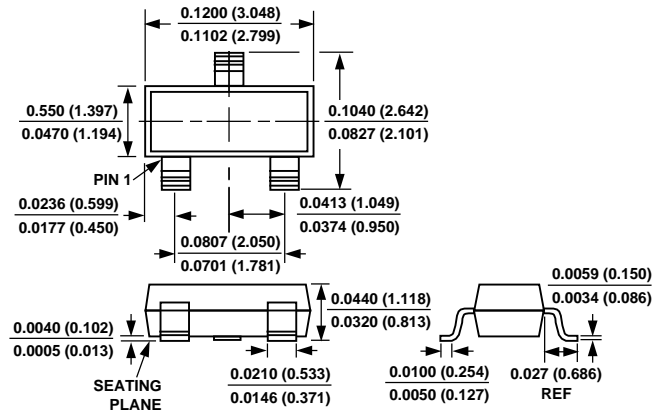

Figure 20. Single Supply System

**OUTLINE DIMENSIONS**  
 Dimensions shown in inches and (mm).  
**SOT-23**



**TAPE AND REEL DIMENSIONS**  
 Dimensions shown in millimeters.

