

SWITCHING  
N-CHANNEL POWER MOS FET  
INDUSTRIAL USE

## DESCRIPTION

The 2SK3306 is N-Channel DMOS FET device that features a low gate charge and excellent switching characteristics, and designed for high voltage applications such as switching power supply, AC adapter.

## ORDERING INFORMATION

PART NUMBER	PACKAGE
2SK3306	Isolated TO-220 (MP-45F)

## FEATURES

- Low gate charge :
- ★  $Q_G = 13 \text{ nC TYP. (} V_{DD} = 400 \text{ V, } V_{GS} = 10 \text{ V, } I_D = 5.0 \text{ A)}$
- Gate voltage rating :  $\pm 30 \text{ V}$
- Low on-state resistance :  
 $R_{DS(on)} = 1.5 \Omega \text{ MAX. (} V_{GS} = 10 \text{ V, } I_D = 2.5 \text{ A)}$
- Avalanche capability ratings
- Isolated TO-220(MP-45F) package

(Isolated TO-220)

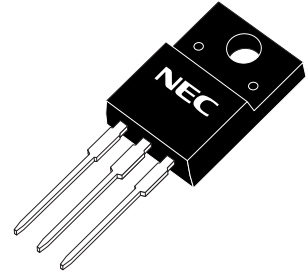
ABSOLUTE MAXIMUM RATINGS ( $T_A = 25^\circ\text{C}$ )

Drain to Source Voltage ( $V_{GS} = 0 \text{ V}$ )	$V_{DSS}$	500	V
Gate to Source Voltage ( $V_{DS} = 0 \text{ V}$ )	$V_{GSS(AC)}$	$\pm 30$	V
Drain Current (DC)	$I_{D(DC)}$	$\pm 5$	A
Drain Current (pulse) <sup>Note1</sup>	$I_{D(pulse)}$	$\pm 20$	A
Total Power Dissipation ( $T_C = 25^\circ\text{C}$ )	$P_T$	35	W
Total Power Dissipation ( $T_A = 25^\circ\text{C}$ )	$P_T$	2.0	W
Channel Temperature	$T_{ch}$	150	$^\circ\text{C}$
Storage Temperature	$T_{stg}$	-55 to +150	$^\circ\text{C}$
Single Avalanche Current <sup>Note2</sup>	$I_{AS}$	5.0	A
Single Avalanche Energy <sup>Note2</sup>	$E_{AS}$	125	mJ

**Notes 1.**  $PW \leq 10 \mu\text{s}$ , Duty Cycle  $\leq 1 \%$

**2.** Starting  $T_{ch} = 25^\circ\text{C}$ ,  $V_{DD} = 150 \text{ V}$ ,  $R_G = 25 \Omega$ ,  $V_{GS} = 20 \text{ V} \rightarrow 0 \text{ V}$

The information in this document is subject to change without notice. Before using this document, please confirm that this is the latest version.  
Not all devices/types available in every country. Please check with local NEC representative for availability and additional information.

**ELECTRICAL CHARACTERISTICS (T<sub>A</sub> = 25 °C)**

CHARACTERISTICS	SYMBOL	MIN.	TYP.	MAX.	UNIT	TEST CONDITIONS
★ Drain Leakage Current	I <sub>DSS</sub>			100	μA	V <sub>DS</sub> = 500 V, V <sub>GS</sub> = 0 V
★ Gate to Source Leakage Current	I <sub>GSS</sub>			±100	nA	V <sub>GS</sub> = ±30 V, V <sub>DS</sub> = 0 V
★ Gate to Source Cut-off Voltage	V <sub>GS(off)</sub>	2.5		3.5	V	V <sub>DS</sub> = 10 V, I <sub>D</sub> = 1 mA
★ Forward Transfer Admittance	y <sub>fs</sub>	1.0	3.0		S	V <sub>DS</sub> = 10 V, I <sub>D</sub> = 2.5 A
★ Drain to Source On-state Resistance	R <sub>DS(on)</sub>		1.35	1.5	Ω	V <sub>GS</sub> = 10 V, I <sub>D</sub> = 2.5 A
★ Input Capacitance	C <sub>iss</sub>		700		pF	V <sub>DS</sub> = 10 V, V <sub>GS</sub> = 0 V, f = 1 MHz
Output Capacitance	C <sub>oss</sub>		115		pF	
Reverse Transfer Capacitance	C <sub>rss</sub>		6		pF	
Turn-on Delay Time	t <sub>d(on)</sub>		16		ns	V <sub>DD</sub> = 150 V, I <sub>D</sub> = 2.5 A, V <sub>GS(on)</sub> = 10 V, R <sub>G</sub> = 10 Ω, R <sub>L</sub> = 60 Ω
Rise Time	t <sub>r</sub>		3		ns	
Turn-off Delay Time	t <sub>d(off)</sub>		33		ns	
Fall Time	t <sub>f</sub>		5.5		ns	
★ Total Gate Charge	Q <sub>G</sub>		13		nC	V <sub>DD</sub> = 400 V, V <sub>GS(on)</sub> = 10 V, I <sub>D</sub> = 5.0 A
★ Gate to Source Charge	Q <sub>GS</sub>		4		nC	
★ Gate to Drain Charge	Q <sub>GD</sub>		4.5		nC	
★ Body Diode Forward Voltage	V <sub>F(S-D)</sub>		1.0		V	I <sub>F</sub> = 5.0 A, V <sub>GS</sub> = 0 V
Reverse Recovery Time	t <sub>rr</sub>		0.7		μs	I <sub>F</sub> = 5.0 A, V <sub>GS</sub> = 0 V, di/dt = 50 A/μs
★ Reverse Recovery Charge	Q <sub>rr</sub>		3.3		μC	

**TEST CIRCUIT 1 AVALANCHE CAPABILITY**

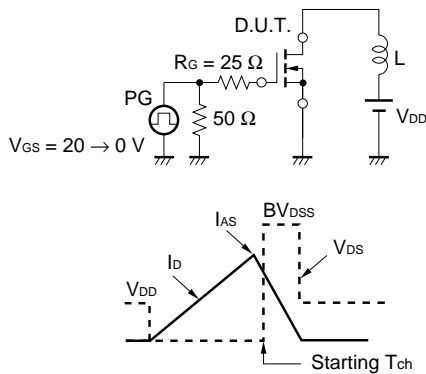

**TEST CIRCUIT 2 SWITCHING TIME**

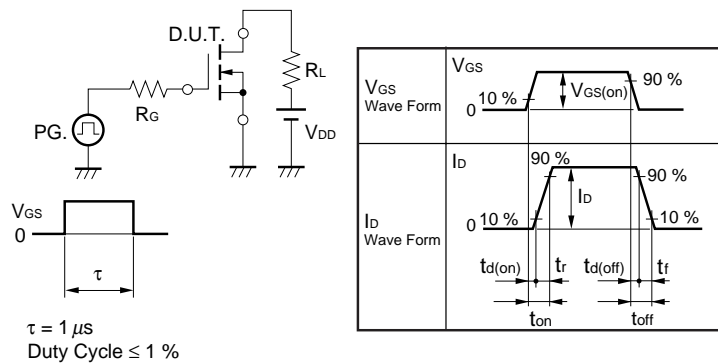

**TEST CIRCUIT 3 GATE CHARGE**

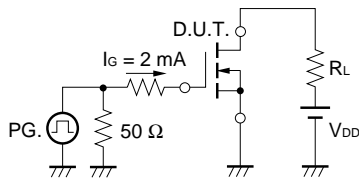

TYPICAL CHARACTERISTICS(T<sub>A</sub> = 25 °C)

DERATING FACTOR OF FORWARD BIAS SAFE OPERATING AREA

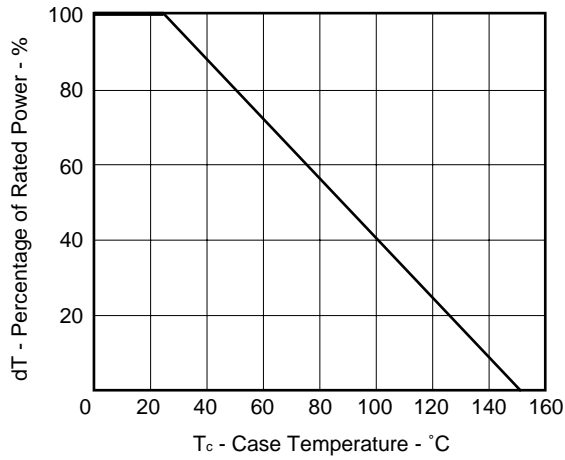

TOTAL POWER DISSIPATION vs. CASE TEMPERATURE

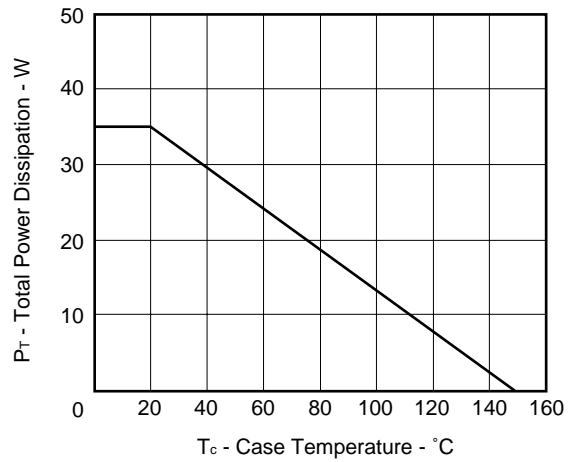

FORWARD BIAS SAFE OPERATING AREA

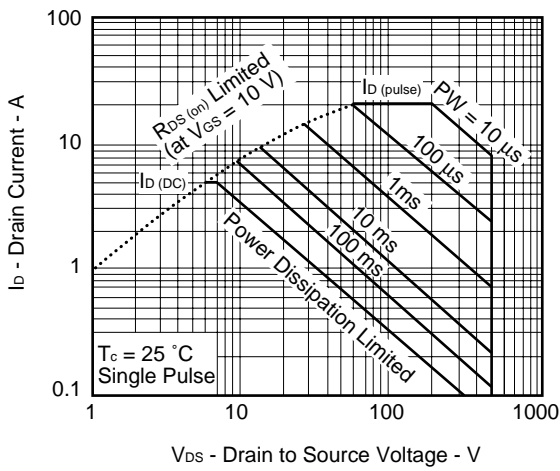

DRAIN CURRENT vs. DRAIN TO SOURCE VOLTAGE

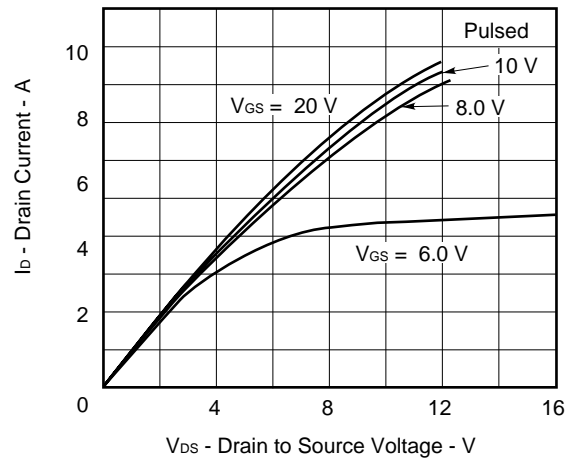

DRAIN CURRENT vs. GATE TO SOURCE VOLTAGE

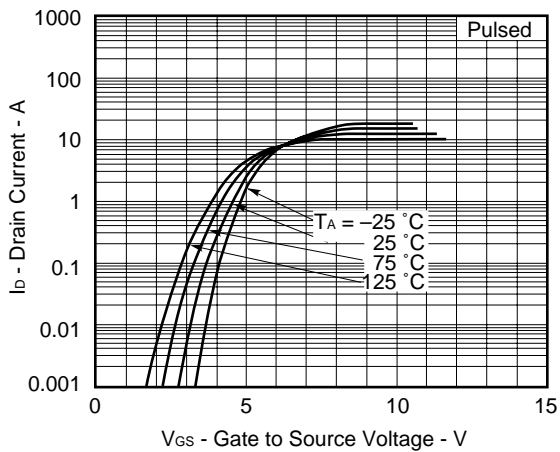

TRANSIENT THERMAL RESISTANCE vs. PULSE WIDTH

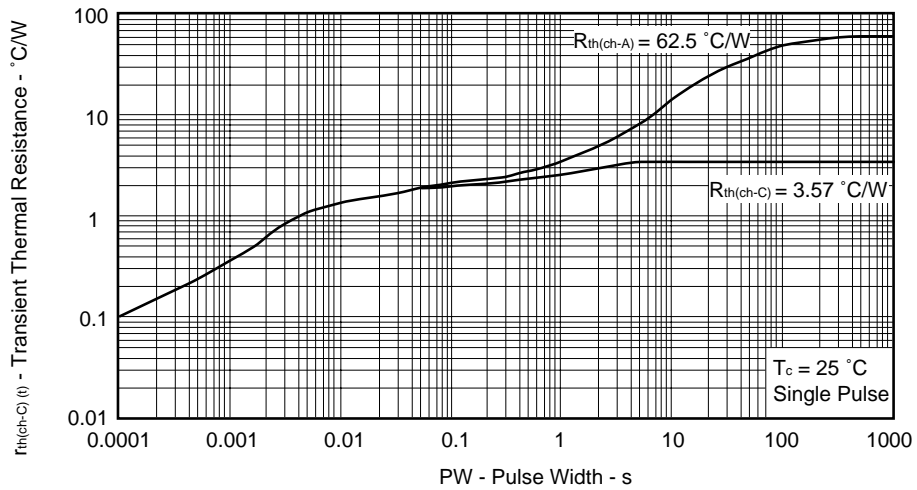

FORWARD TRANSFER ADMITTANCE vs. DRAIN CURRENT

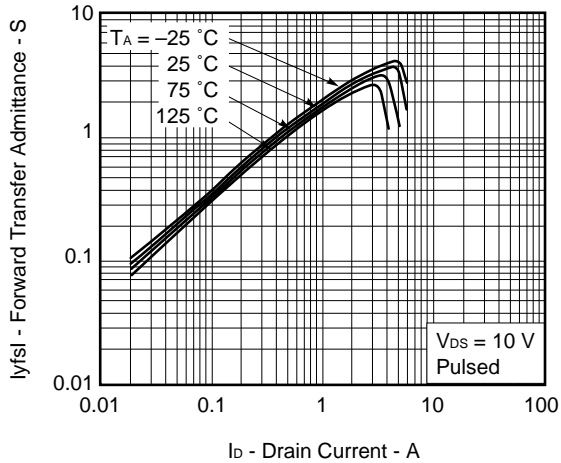

DRAIN TO SOURCE ON-STATE RESISTANCE vs. GATE TO SOURCE VOLTAGE

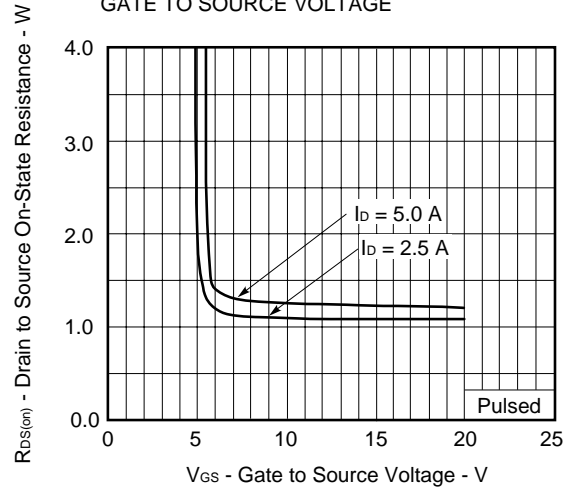

DRAIN TO SOURCE ON-STATE RESISTANCE vs. DRAIN CURRENT

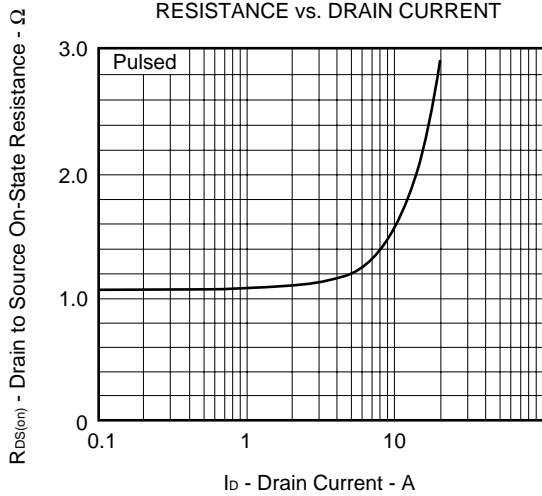

GATE TO SOURCE CUT-OFF VOLTAGE vs. CHANNEL TEMPERATURE

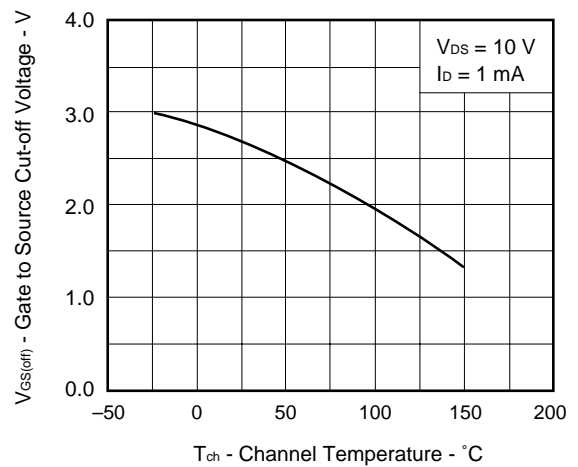

DRAIN TO SOURCE ON-STATE RESISTANCE vs. CHANNEL TEMPERATURE

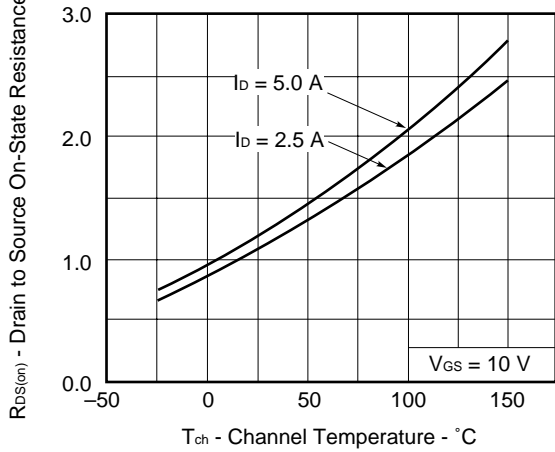

SOURCE TO DRAIN DIODE FORWARD VOLTAGE

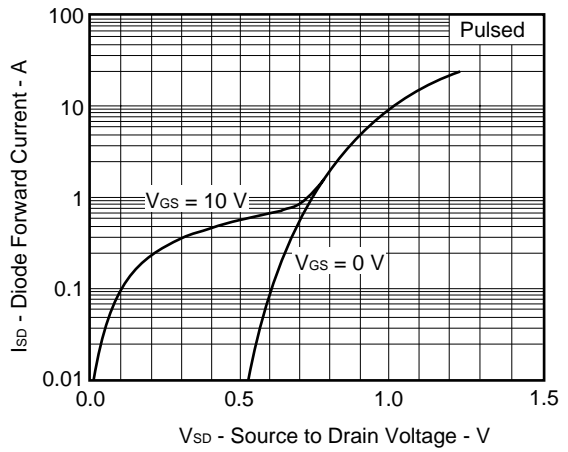

CAPACITANCE vs. DRAIN TO SOURCE VOLTAGE

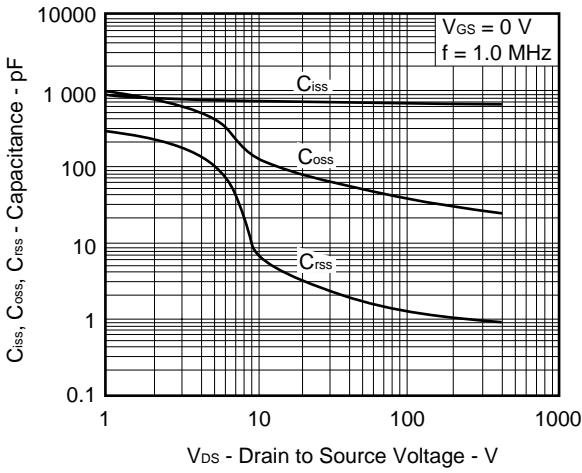

SWITCHING CHARACTERISTICS

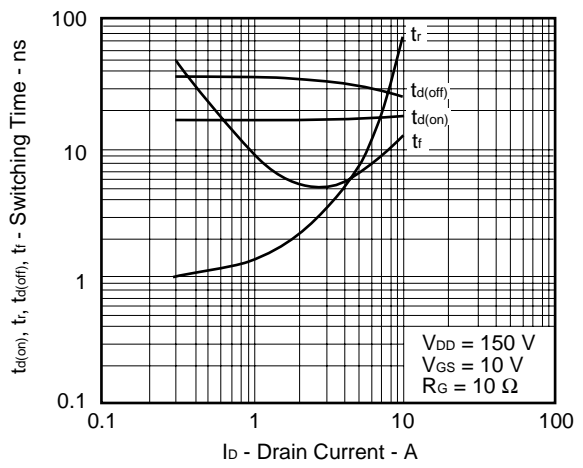

REVERSE RECOVERY TIME vs. DRAIN CURRENT

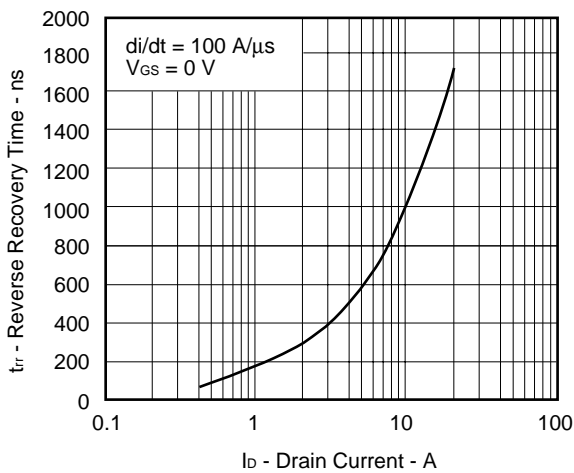

DYNAMIC INPUT/OUTPUT CHARACTERISTICS

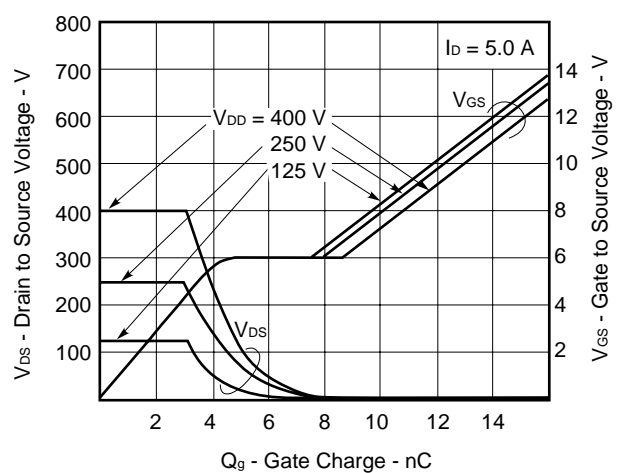

SINGLE AVALANCHE ENERGY vs  
STARTING CHANNEL TEMPERATURE

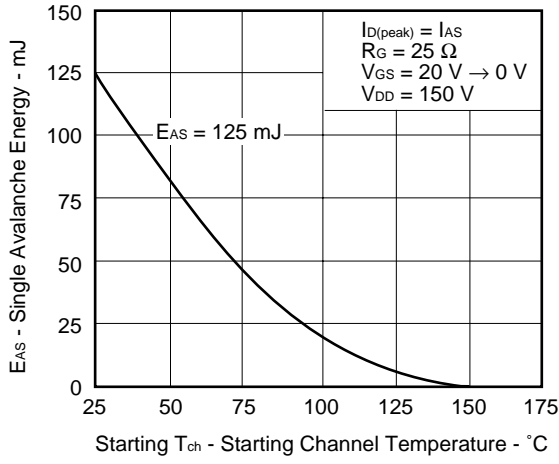

SINGLE AVALANCHE CURRENT vs  
INDUCTIVE LOAD

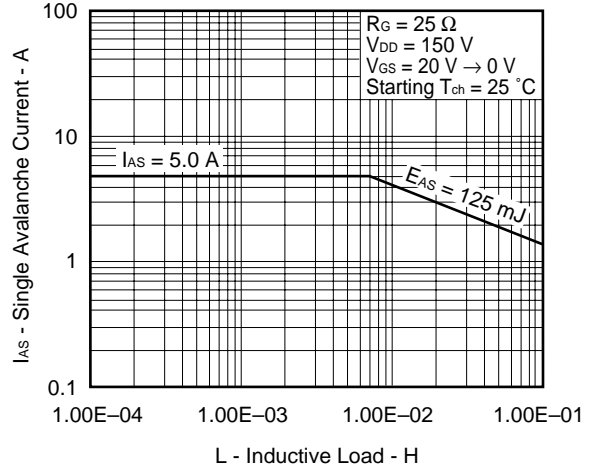

PACKAGE DRAWING (Unit: mm)

Isolated TO-220(MP-45F)

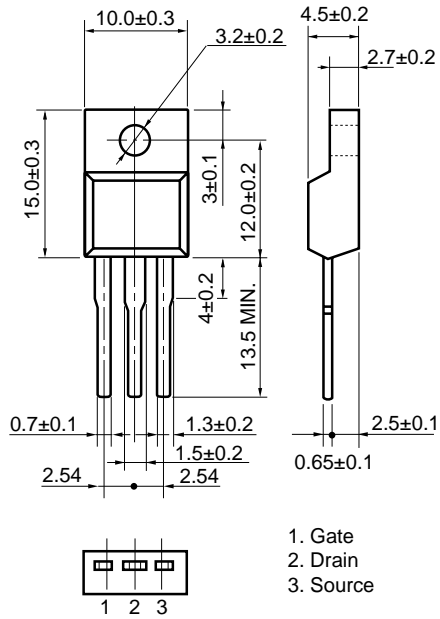

EQUIVALENT CIRCUIT

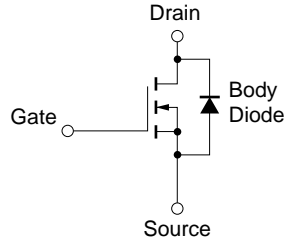

★ **Remark** Strong electric field, when exposed to this device, cause destruction of the gate oxide and ultimately degrade the device operation. Steps must be taken to stop generation of static electricity as much as possible, and quickly dissipate it once, when it has occurred.

- **The information in this document is subject to change without notice. Before using this document, please confirm that this is the latest version.**
  - No part of this document may be copied or reproduced in any form or by any means without the prior written consent of NEC Corporation. NEC Corporation assumes no responsibility for any errors which may appear in this document.
  - NEC Corporation does not assume any liability for infringement of patents, copyrights or other intellectual property rights of third parties by or arising from use of a device described herein or any other liability arising from use of such device. No license, either express, implied or otherwise, is granted under any patents, copyrights or other intellectual property rights of NEC Corporation or others.
  - Descriptions of circuits, software, and other related information in this document are provided for illustrative purposes in semiconductor product operation and application examples. The incorporation of these circuits, software, and information in the design of the customer's equipment shall be done under the full responsibility of the customer. NEC Corporation assumes no responsibility for any losses incurred by the customer or third parties arising from the use of these circuits, software, and information.
  - While NEC Corporation has been making continuous effort to enhance the reliability of its semiconductor devices, the possibility of defects cannot be eliminated entirely. To minimize risks of damage or injury to persons or property arising from a defect in an NEC semiconductor device, customers must incorporate sufficient safety measures in its design, such as redundancy, fire-containment, and anti-failure features.
  - NEC devices are classified into the following three quality grades:  
"Standard", "Special", and "Specific". The Specific quality grade applies only to devices developed based on a customer designated "quality assurance program" for a specific application. The recommended applications of a device depend on its quality grade, as indicated below. Customers must check the quality grade of each device before using it in a particular application.
    - Standard: Computers, office equipment, communications equipment, test and measurement equipment, audio and visual equipment, home electronic appliances, machine tools, personal electronic equipment and industrial robots
    - Special: Transportation equipment (automobiles, trains, ships, etc.), traffic control systems, anti-disaster systems, anti-crime systems, safety equipment and medical equipment (not specifically designed for life support)
    - Specific: Aircraft, aerospace equipment, submersible repeaters, nuclear reactor control systems, life support systems or medical equipment for life support, etc.
- The quality grade of NEC devices is "Standard" unless otherwise specified in NEC's Data Sheets or Data Books. If customers intend to use NEC devices for applications other than those specified for Standard quality grade, they should contact an NEC sales representative in advance.