

### Typical Applications

- CDMA/FM Cellular Systems
- Supports Dual-Mode AMPS/CDMA
- Supports Dual-Mode TACS/CDMA
- Commercial and Consumer Systems
- 3-Cell Battery-Operated Systems

### Product Description

The RF9908 is a complete upconverter designed for CDMA/FM cellular applications. The IC contains a double-balanced mixer stage and an output buffer amplifier stage. This device may also be used to directly BPSK modulate a carrier. The mixer is a Gilbert cell with emitter degeneration resistors to provide high  $IP_3$ . The output stage is a class-B, push-pull configuration to reduce the overall current and still provide a good  $50\Omega$  output match. The unit operates at 3.6V and does not require any external matching components other than coupling capacitors. This circuit is designed as part of the RFMD CDMA Chip Set, consisting of a Transmit IF AGC Amp, this Transmit Upconverter, a Receive LNA/Mixer, and a Receive IF AGC Amp.

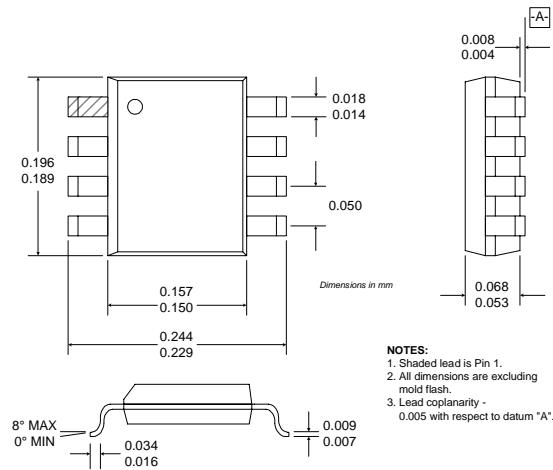

### Optimum Technology Matching® Applied

- |                                     |  |                                      |
|-------------------------------------|--|--------------------------------------|
| <input type="checkbox"/> Si BJT     | <input checked="" type="checkbox"/> GaAs HBT | <input type="checkbox"/> GaAs MESFET |
| <input type="checkbox"/> Si Bi-CMOS | <input type="checkbox"/> SiGe HBT            | <input type="checkbox"/> Si CMOS     |

Package Style: SOIC-8

### Features

- Supports Dual Mode Operation
- +8dBm Input/Output Intercept Point
- Single 3.6V Power Supply
- Internally Matched Inputs and Outputs
- Buffered Output
- Double-Balanced Mixer

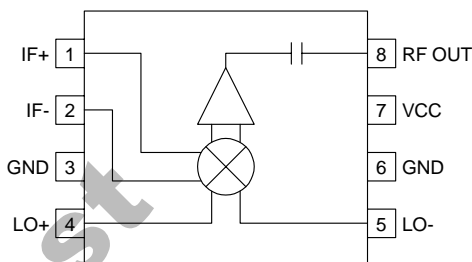

Functional Block Diagram

### Ordering Information

- |             |                                    |
|-------------|------------------------------------|
| RF9908      | CDMA/FM Upconverter/BPSK Modulator |
| RF9908 PCBA | Fully Assembled Evaluation Board   |

RF Micro Devices, Inc.  
 7628 Thorndike Road  
 Greensboro, NC 27409, USA

Tel (336) 664 1233  
 Fax (336) 664 0454  
<http://www.rfmd.com>

# RF9908

## Absolute Maximum Ratings

Parameter	Rating	Unit
Supply Voltage	-0.5 to 7.0	V <sub>DC</sub>
Input RF Power	+6	dBm
Operating Ambient Temperature	-40 to +85	°C
Storage Temperature	-40 to +150	°C



Caution! ESD sensitive device.

RF Micro Devices believes the furnished information is correct and accurate at the time of this printing. However, RF Micro Devices reserves the right to make changes to its products without notice. RF Micro Devices does not assume responsibility for the use of the described product(s).

Parameter	Specification			Unit	Condition
	Min.	Typ.	Max.		
<b>Overall</b>					T=25°C, V <sub>CC</sub> =3.6V, RF=840MHz, LO=970MHz, IF=130MHz
RF Output Frequency Range		500 to 1500		MHz	Over temperature and frequency
Conversion Gain		0		dB	
Noise Figure		14		dB	Referenced to a 1.23MHz in-band power. (±885kHz offset)
Output IP3		+8		dBm	
Output ACP		-54		dB	
Output ALT		-75		dB	
Output VSWR		1.5:1			50Ω
Spurious Product Rejection		30		dBc	Referenced to RF output
<b>IF Input</b>					
IF Frequency		DC to 200		MHz	
Differential Input Impedance		265		Ω	
IF to RF Output Isolation		30		dB	
IF to LO Isolation		30		dB	
<b>LO Input</b>					
LO Frequency Range		300 to 1700		MHz	
LO Level		-6 to 0		dBm	
LO to RF Output Leakage		-30	-20	dBm	
RF to LO Isolation		30		dB	
LO Input VSWR		2:1			50Ω
<b>Power Supply</b>					
Voltage		3.6±5%		V	
Current Consumption		18		mA	

6

MIXERS

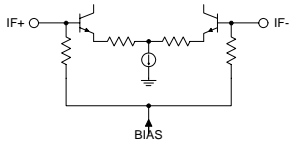
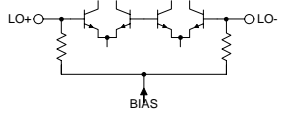
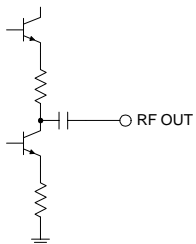
Pin	Function	Description	Interface Schematic
1	IF+	Balanced IF Input Pin. This pin is internally DC biased and should be DC blocked if connected to a device with a DC level present. For single-ended input operation, one pin is used as an input and the other IF input is AC coupled to ground. The balanced, as well as single-ended, input impedance is 265Ω.	
2	IF-	Same as pin 1, except complementary input.	See pin 1.
3	GND	Ground connection. Keep traces physically short and connect immediately to ground plane for best performance.	
4	LO+	Balanced LO Input Pin. This pin is internally DC biased and should be DC blocked if connected to a device with a DC level present. For single-ended input operation, one pin is used as an input and the other LO input is AC coupled to ground. The balanced, as well single-ended, input impedance is 50Ω.	
5	LO-	Same as pin 4, except complementary input.	See pin 4.
6	GND	Same as pin 3.	
7	VCC	Supply Voltage pin. External bypassing is required. External RF, LO, and IF bypassing is required. The trace length between the pin and the bypass capacitors should be minimized. The ground side of the bypass capacitors should connect immediately to ground plane.	
8	RF OUT	RF Output Pin. This pin is internally DC blocked. The output impedance is 50Ω.	

## Application Schematic

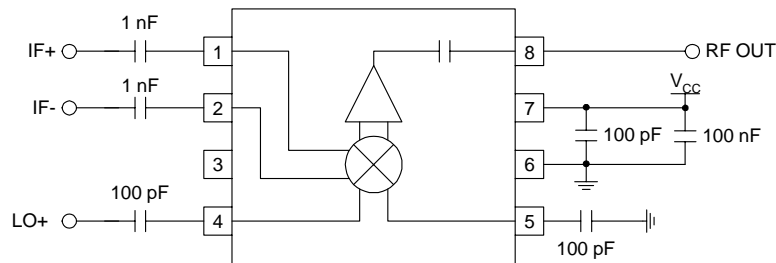

## Evaluation Board Schematic

(Download [Bill of Materials](http://www.rfmd.com) from [www.rfmd.com](http://www.rfmd.com).)

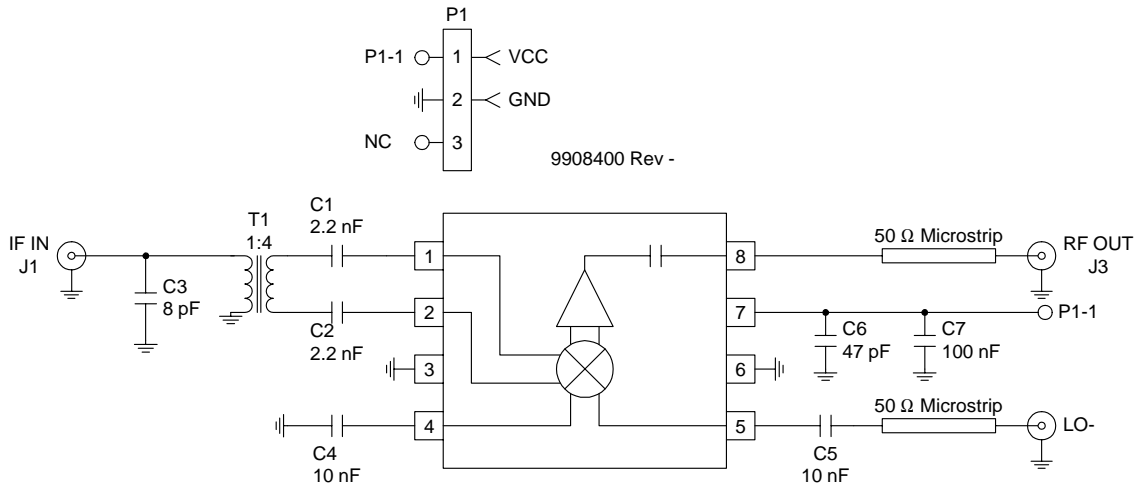

## Evaluation Board Layout

Board Size 1.4" x 1.4"

Board Thickness 0.031", Board Material FR-4

