

PM50RSK060

FLAT-BASE TYPE
INSULATED PACKAGE

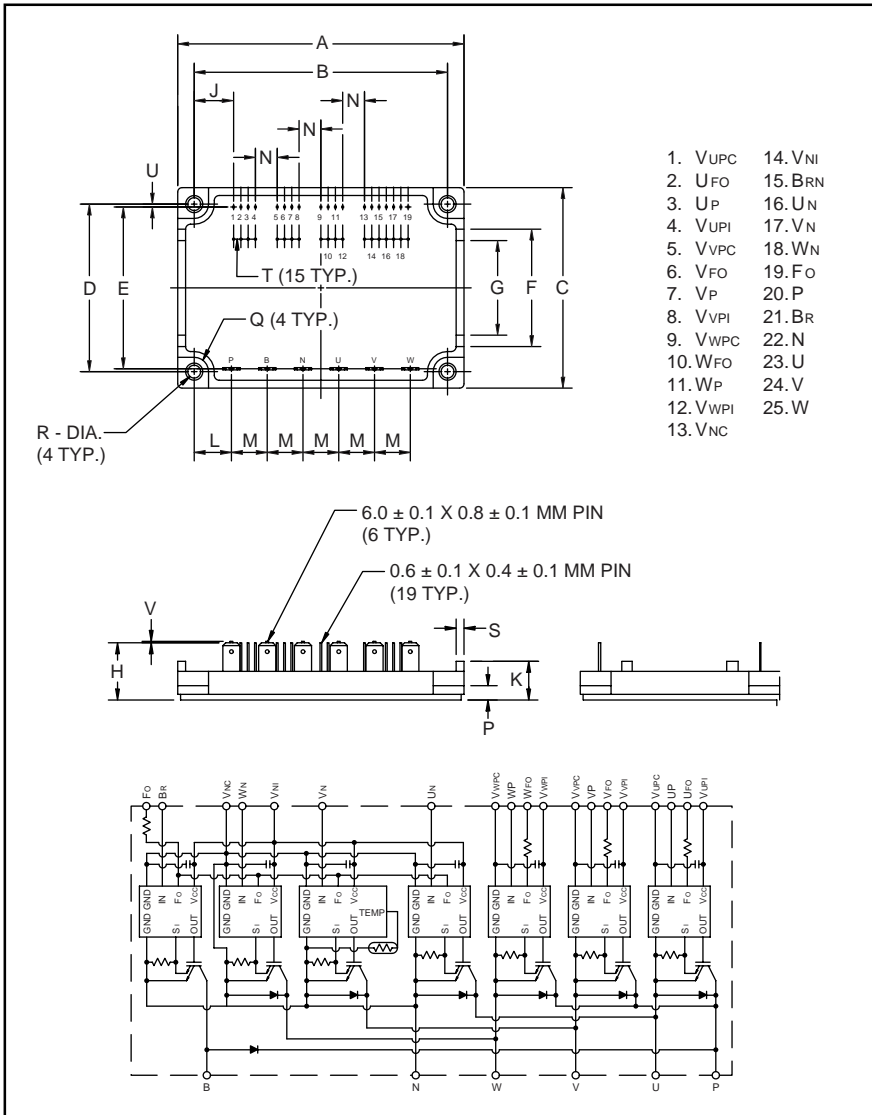

- | | |
|----------|---------|
| 1. VUPC | 14. VNI |
| 2. UFO | 15. BRN |
| 3. UP | 16. UN |
| 4. VUPI | 17. VN |
| 5. VVPC | 18. WN |
| 6. VFO | 19. FO |
| 7. VP | 20. P |
| 8. VVPI | 21. BR |
| 9. VWPC | 22. N |
| 10. WFO | 23. U |
| 11. WP | 24. V |
| 12. VWPI | 25. W |
| 13. VNC | |



Description:

Mitsubishi Intelligent Power Modules are isolated base modules designed for power switching applications operating at frequencies to 20kHz. Built-in control circuits provide optimum gate drive and protection for the IGBT and free-wheel diode power devices.

Features:

- Complete Output Power Circuit
- Gate Drive Circuit
- Protection Logic
 - Short Circuit
 - Over Current
 - Over Temperature
 - Under Voltage

Applications:

- Inverters
- UPS
- Motion/Servo Control
- Power Supplies

Ordering Information:

Example: Select the complete part number from the table below -i.e. PM50RSK060 is a 600V, 50 Ampere Intelligent Power Module.

Outline Drawing and Circuit Diagram

Dimensions	Inches	Millimeters
A	3.96±0.04	100.5±1.0
B	3.48±0.02	88.5±0.5
C	2.76±0.04	70.0±1.0
D	2.30±0.02	58.5±0.5
E	2.22±0.02	56.5±0.5
F	1.61	41.0
G	1.30	33.0
H	0.75±0.04	19.0±1.0
J	0.542	13.77
K	0.53	13.5

Dimensions	Inches	Millimeters
L	0.51	13.0
M	0.49±0.01	12.5±0.25
N	0.300±0.01	7.62
P	0.22	5.5
Q	0.20 Rad.	Rad. 5.0
R	0.18 Dia.	Dia. 4.5
S	0.108	2.75
T	0.100±0.01	2.54±0.25
U	0.030	0.75
V	0.04	1.0

Type	Current Rating Amperes	V _{CES} Volts (x 10)
PM	50	60

PM50RSK060

FLAT-BASE TYPE
INSULATED PACKAGE

Absolute Maximum Ratings, $T_j = 25^\circ\text{C}$ unless otherwise specified

Ratings	Symbol	PM50RSK060	Units
Power Device Junction Temperature	T_j	-20 to 150	$^\circ\text{C}$
Storage Temperature	T_{stg}	-40 to 125	$^\circ\text{C}$
Case Operating Temperature	T_C	-20 to 100	$^\circ\text{C}$
Mounting Torque, M4 Mounting Screws	—	0.98 ~ 1.47	$\text{N} \cdot \text{m}$
Module Weight (Typical)	—	110	Grams
Supply Voltage Protected by OC and SC ($V_D = 13.5 - 16.5\text{V}$, Inverter Part, $T_j = 125^\circ\text{C}$)	$V_{\text{CC(prot.)}}$	400	Volts
Isolation Voltage (Main Terminal to Baseplate, AC 1 min.)	V_{iso}	2500	Vrms

Control Sector

Supply Voltage (Applied between $V_{\text{UP1}}-V_{\text{UPC}}$, $V_{\text{VP1}}-V_{\text{VPC}}$, $V_{\text{WP1}}-V_{\text{WPC}}$, $V_{\text{N1}}-V_{\text{NC}}$)	V_D	20	Volts
Input Voltage (Applied between U_P-V_{UPC} , V_P-V_{VPC} , W_P-V_{WPC} , $U_N \cdot V_N \cdot W_N-V_{\text{NC}}$)	V_{CIN}	20	Volts
Fault Output Supply Voltage (Applied between $U_{\text{FO}}-V_{\text{UPC}}$, $V_{\text{FO}}-V_{\text{VPC}}$, $W_{\text{FO}}-V_{\text{WPC}}$, F_O-V_{NC})	V_{FO}	20	Volts
Fault Output Current (Sink Current of U_{FO} , V_{FO} , W_{FO} and F_O Terminal)	I_{FO}	20	mA

IGBT Inverter Sector

Collector-Emitter Voltage ($V_D = 15\text{V}$, $V_{\text{CIN}} = 15\text{V}$)	V_{CES}	600	Volts
Collector Current, \pm	I_C	50	Amperes
Peak Collector Current, \pm	I_{CP}	100	Amperes
Supply Voltage (Applied between P - N)	V_{CC}	450	Volts
Supply Voltage, Surge (Applied between P - N)	$V_{\text{CC(surge)}}$	500	Volts
Collector Dissipation	P_C	100	Watts

Brake Sector

Collector-Emitter Voltage ($V_D = 15\text{V}$, $V_{\text{CIN}} = 15\text{V}$)	V_{CES}	600	Volts
Collector Current, ($T_C = 25^\circ\text{C}$)	I_C	15	Amperes
Peak Collector Current, ($T_C = 25^\circ\text{C}$)	I_{CP}	30	Amperes
Supply Voltage (Applied between P - N)	V_{CC}	450	Volts
Supply Voltage, Surge (Applied between P - N)	$V_{\text{CC(surge)}}$	500	Volts
Collector Dissipation	P_C	43	Watts
Diode Forward Current	I_F	15	Amperes
Diode DC Reverse Voltage	$V_{\text{R(DC)}}$	600	Volts

PM50RSK060

FLAT-BASE TYPE
INSULATED PACKAGE

Electrical and Mechanical Characteristics, $T_j = 25^\circ\text{C}$ unless otherwise specified

Characteristics	Symbol	Test Conditions	Min.	Typ.	Max.	Units
Control Sector						
Over Current Trip Level Inverter Part	OC	$-20^\circ\text{C} \leq T \leq 125^\circ\text{C}$, $V_D = 15\text{V}$	65	88	—	Amperes
Over Current Trip Level Brake Part			18	26	—	Amperes
Short Circuit Trip Level Inverter Part	SC	$-20^\circ\text{C} \leq T \leq 125^\circ\text{C}$, $V_D = 15\text{V}$	—	132	—	Amperes
Short Circuit Trip Level Brake Part			—	39	—	Amperes
Over Current Delay Time	$t_{\text{off(OC)}}$	$V_D = 15\text{V}$	—	10	—	μs
Over Temperature Protection	OT	Trip Level	100	110	120	$^\circ\text{C}$
	OT_r	Reset Level	—	90	—	$^\circ\text{C}$
Supply Circuit Under Voltage Protection	UV	Trip Level	11.5	12.0	12.5	Volts
	UV_r	Reset Level	—	12.5	—	Volts
Supply Voltage	V_D	Applied between $V_{UP1}-V_{UPC}$, $V_{VP1}-V_{VPC}$, $V_{WP1}-V_{WPC}$, $V_{N1}-V_{NC}$	13.5	15	16.5	Volts
Circuit Current	I_D	$V_D = 15\text{V}$, $V_{CIN} = 15\text{V}$, $V_{N1}-V_{NC}$	—	44	60	mA
		$V_D = 15\text{V}$, $V_{CIN} = 15\text{V}$, $V_{XP1}-V_{XPC}$	—	13	18	mA
Input ON Threshold Voltage	$V_{\text{th(on)}}$	Applied between	1.2	1.5	1.8	Volts
Input OFF Threshold Voltage	$V_{\text{th(off)}}$	U_P-V_{UPC} , V_P-V_{VPC} , W_P-V_{WPC} , $U_N \cdot V_N \cdot W_N \cdot B_r-V_{NC}$	1.7	2.0	2.3	Volts
PWM Input Frequency	f_{PWM}	3- ϕ Sinusoidal	—	15	20	kHz
Fault Output Current	$I_{\text{FO(H)}}$	$V_D = 15\text{V}$, $V_{\text{FO}} = 15\text{V}$	—	—	0.01	mA
	$I_{\text{FO(L)}}$	$V_D = 15\text{V}$, $V_{\text{FO}} = 15\text{V}$	—	10	15	mA
Minimum Fault Output Pulse Width	t_{FO}	$V_D = 15\text{V}$	1.0	1.8	—	ms

PM50RSK060

 FLAT-BASE TYPE
 INSULATED PACKAGE

Electrical and Mechanical Characteristics, $T_j = 25^\circ\text{C}$ unless otherwise specified

Characteristics	Symbol	Test Conditions	Min.	Typ.	Max.	Units
IGBT Inverter Sector						
Collector Cutoff Current	I_{CES}	$V_{CE} = V_{CES}, T_j = 25^\circ\text{C}$	—	—	1.0	mA
		$V_{CE} = V_{CES}, T_j = 125^\circ\text{C}$	—	—	10	mA
Diode Forward Voltage	V_{EC}	$-I_C = 50\text{A}, V_D = 15\text{V}, V_{CIN} = 15\text{V}$	—	2.2	3.3	Volts
Collector-Emitter Saturation Voltage	$V_{CE(sat)}$	$V_D = 15\text{V}, V_{CIN} = 0\text{V}, I_C = 50\text{A}$	—	1.8	2.7	Volts
		$V_D = 15\text{V}, V_{CIN} = 0\text{V}, I_C = 50\text{A}, T_j = 125^\circ\text{C}$	—	1.85	2.78	Volts
Inductive Load Switching Times	t_{on}		0.4	0.8	2.0	μs
	t_{rr}	$V_D = 15\text{V}, V_{CIN} = 0 \leftrightarrow 15\text{V}$	—	0.15	0.3	μs
	$t_{C(on)}$	$V_{CC} = 300\text{V}, I_C = 50\text{A}$	—	0.4	1.0	μs
	t_{off}	$T_j = 125^\circ\text{C}$	—	2.0	2.9	μs
	$t_{C(off)}$		—	0.5	1.0	μs
Brake Sector						
Collector-Emitter Saturation Voltage	$V_{CE(sat)}$	$V_D = 15\text{V}, V_{CIN} = 0\text{V}, I_C = 15\text{A}, T_j = 25^\circ\text{C}$	—	2.6	3.5	Volts
		$V_D = 15\text{V}, V_{CIN} = 0\text{V}, I_C = 15\text{A}, T_j = 125^\circ\text{C}$	—	3.0	4.0	Volts
Diode Forward Voltage	V_{FM}	$I_F = 15\text{A}, V_D = 15\text{V}, V_{CIN} = 5\text{V}$	—	1.7	2.2	Volts
Collector Cutoff Current	I_{CES}	$V_{CE} = V_{CES}, T_j = 25^\circ\text{C}$	—	—	1	mA
		$V_{CE} = V_{CES}, T_j = 125^\circ\text{C}$	—	—	10	mA

PM50RSK060

FLAT-BASE TYPE
INSULATED PACKAGE

Thermal Characteristics

Characteristic	Symbol	Condition	Min.	Typ.	Max.	Units
Junction to Case Thermal Resistance	$R_{th(j-c)Q}$	Each Inverter IGBT	—	—	1.25	°C/Watt
	$R_{th(j-c)F}$	Each Inverter FWDi	—	—	3.0	°C/Watt
	$R_{th(c-f)Q}$	Each Brake IGBT	—	—	2.9	°C/Watt
	$R_{th(c-f)F}$	Each Brake FWDi	—	—	5.4	°C/Watt
Contact Thermal Resistance	$R_{th(c-f)}$	Case to Fin Per Module, Thermal Grease Applied	—	—	0.038	°C/Watt

Recommended Conditions for Use

Characteristic	Symbol	Condition	Value	Units
Supply Voltage	V_{CC}	Applied across P-N Terminals	0 ~ 400	Volts
	V_D	Applied between V_{UP1} - V_{UPC} , V_{N1} - V_{NC} , V_{VP1} - V_{VPC} , V_{WP1} - V_{WPC}	15 ± 1.5	Volts
Input ON Voltage	$V_{CIN(on)}$	Applied between	0 ~ 0.8	Volts
Input OFF Voltage	$V_{CIN(off)}$	U_P - V_{UPC} , V_P - V_{VPC} , W_P - V_{WPC} , U_N · V_N · W_N · B_r - V_{NC}	$4.0 \sim V_D$	Volts
PWM Input Frequency	f_{PWM}	Using Application Circuit	5 ~ 20	kHz
Minimum Dead Time	t_{dead}	Input Signal	≥ 2.5	μs

PM50RSK060

FLAT-BASE TYPE
INSULATED PACKAGE

Inverter Part

SATURATION VOLTAGE CHARACTERISTICS (TYPICAL)

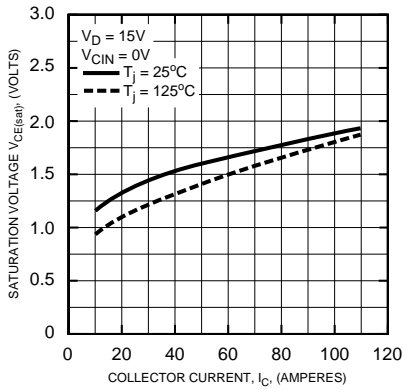

COLLECTOR-EMITTER SATURATION VOLTAGE CHARACTERISTICS (TYPICAL)

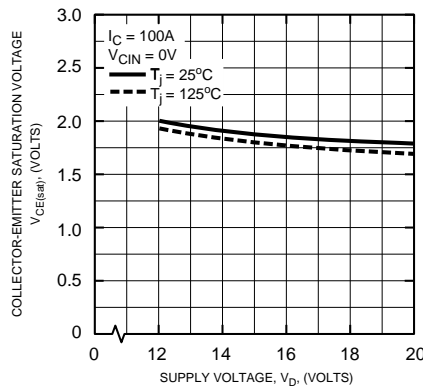

OUTPUT CHARACTERISTICS (TYPICAL)

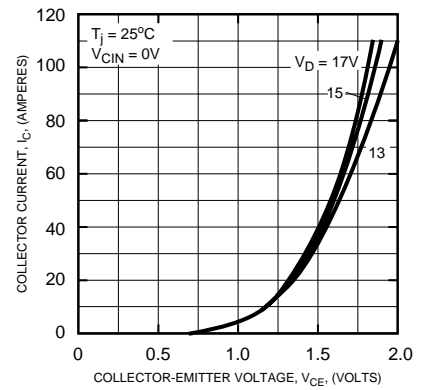

SWITCHING TIME VS. COLLECTOR CURRENT (TYPICAL)

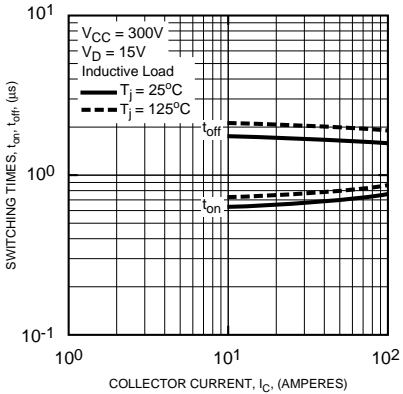

SWITCHING TIME VS. COLLECTOR CURRENT (TYPICAL)

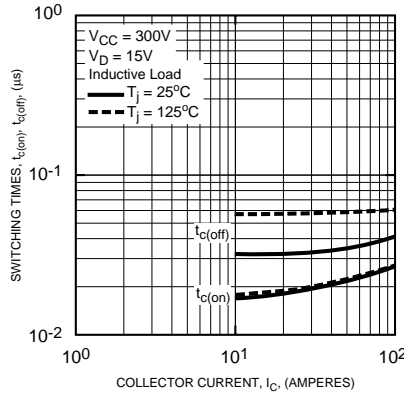

REVERSE RECOVERY CURRENT VS. COLLECTOR CURRENT (TYPICAL)

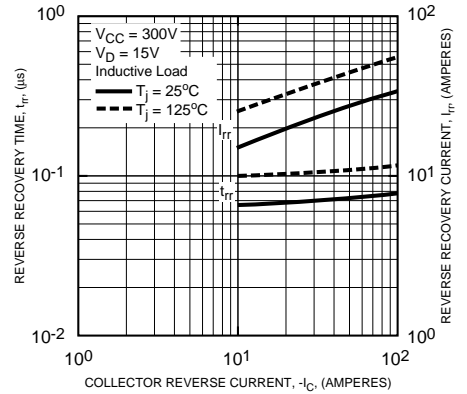

DIODE FORWARD CHARACTERISTICS

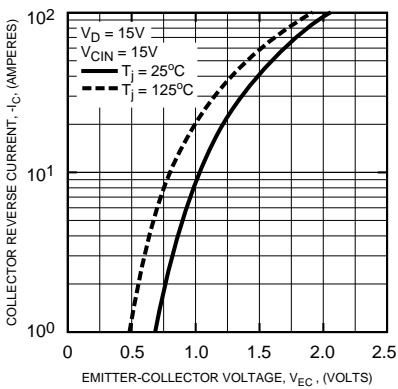

OVER CURRENT TRIP LEVEL VS. SUPPLY VOLTAGE (TYPICAL)

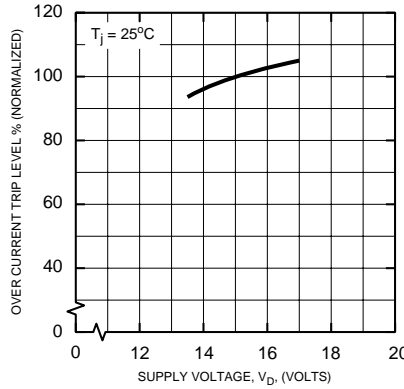

OVER CURRENT TRIP LEVEL VS. TEMPERATURE (TYPICAL)

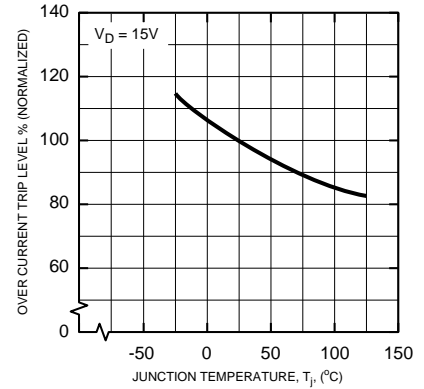

PM50RSK060

FLAT-BASE TYPE
INSULATED PACKAGE

Inverter Part

FAULT OUTPUT PULSE WIDTH VS. TEMPERATURE (TYPICAL)

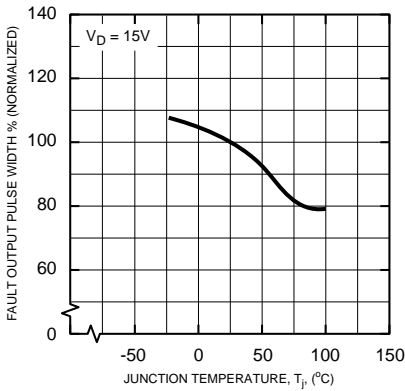

CONTROL SUPPLY VOLTAGE TRIP-RESET LEVEL TEMPERATURE DEPENDENCY (TYPICAL)

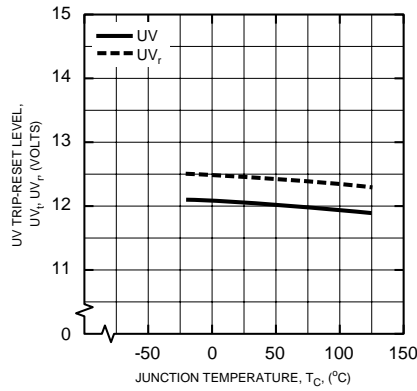

TRANSIENT THERMAL IMPEDANCE CHARACTERISTICS (Each IGBT)

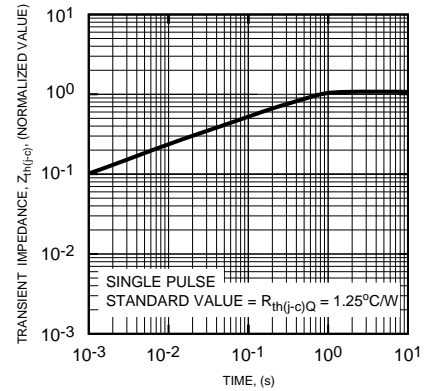

TRANSIENT THERMAL IMPEDANCE CHARACTERISTICS (Each FWD)

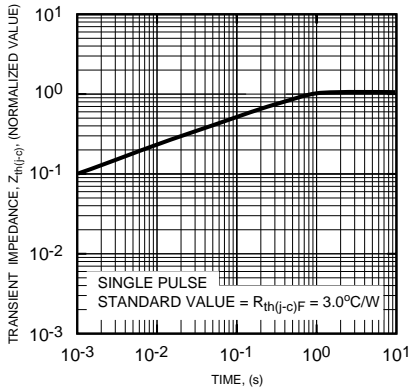

PM50RSK060

FLAT-BASE TYPE
INSULATED PACKAGE

Brake Part

SATURATION VOLTAGE CHARACTERISTICS (TYPICAL)

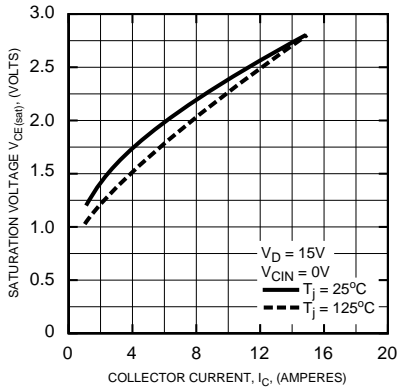

COLLECTOR-EMITTER SATURATION VOLTAGE CHARACTERISTICS (TYPICAL)

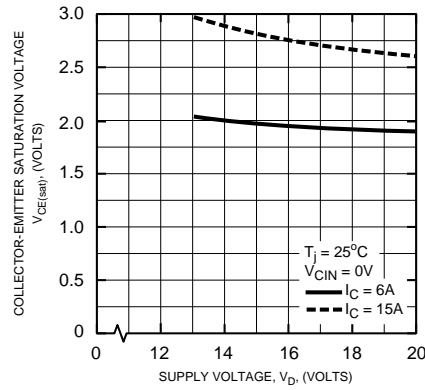

OUTPUT CHARACTERISTICS (TYPICAL)

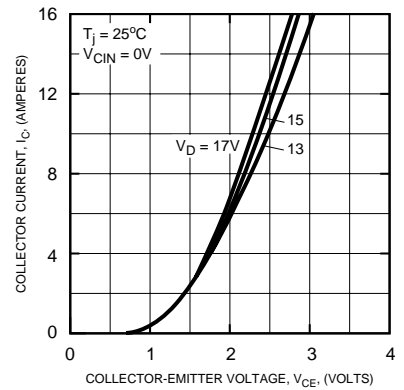

DIODE FORWARD CHARACTERISTICS

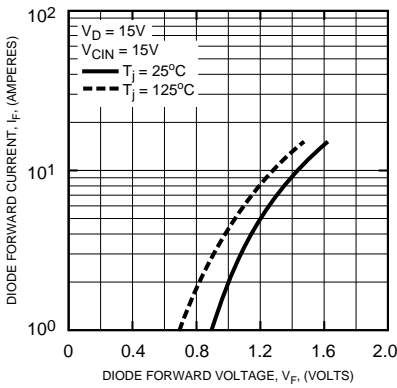

TRANSIENT THERMAL IMPEDANCE CHARACTERISTICS (Each IGBT)

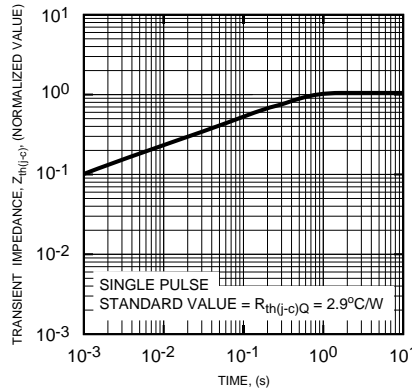

TRANSIENT THERMAL IMPEDANCE CHARACTERISTICS (Each FWDi)

