

SANYO

No. 4105A

LB8106M**Actuator Driver for Portable CD Players**

Overview

The LB8106M is a four-channel actuator driver for driving the focus coil, tracking coil, spindle motor and sled motor in portable CD players.

The LB8106M features a 3.9 V (typ) output up converter, an integrating amplifier to allow the future use of a digital servomotor for the spindle, and a battery check comparator. It supports system startup and stop functions, a selectable sled actuator driver step mode for reduced power consumption, and a defect function to improve tracking when there is a disk fault.

The LB8106M operates from a 2.0 to 4.0 V supply and is available in 44-pin QIPs.

Features

- Four H-bridge actuator drivers for the focus coil, tracking coil, spindle motor and sled motor
- On-chip 3.9 V (typ) up converter
- System startup and stop functions
- Selectable sled actuator driver step mode
- On-chip battery check comparator
- PWM power supply reduces power consumption, noise and the number of external components required.
- On-chip integrating amplifier for future digital spindle servomotor
- Defect function to improve tracking when there is a disk fault
- 2.0 to 4.0 V supply
- 44-pin QIP

Pin Assignment

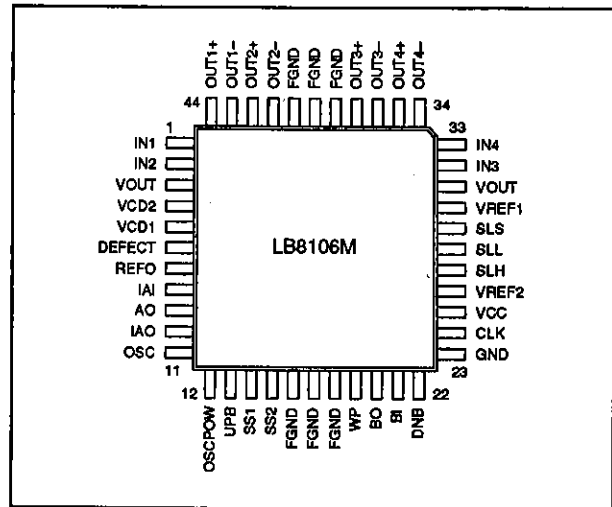

Package Dimensions

Unit: mm

3148-QIP44MA

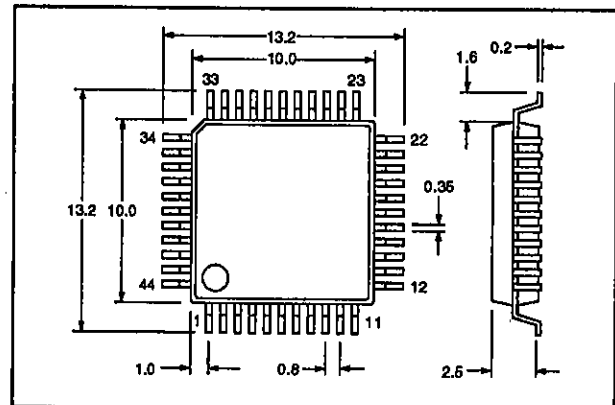

Sample Application Circuit

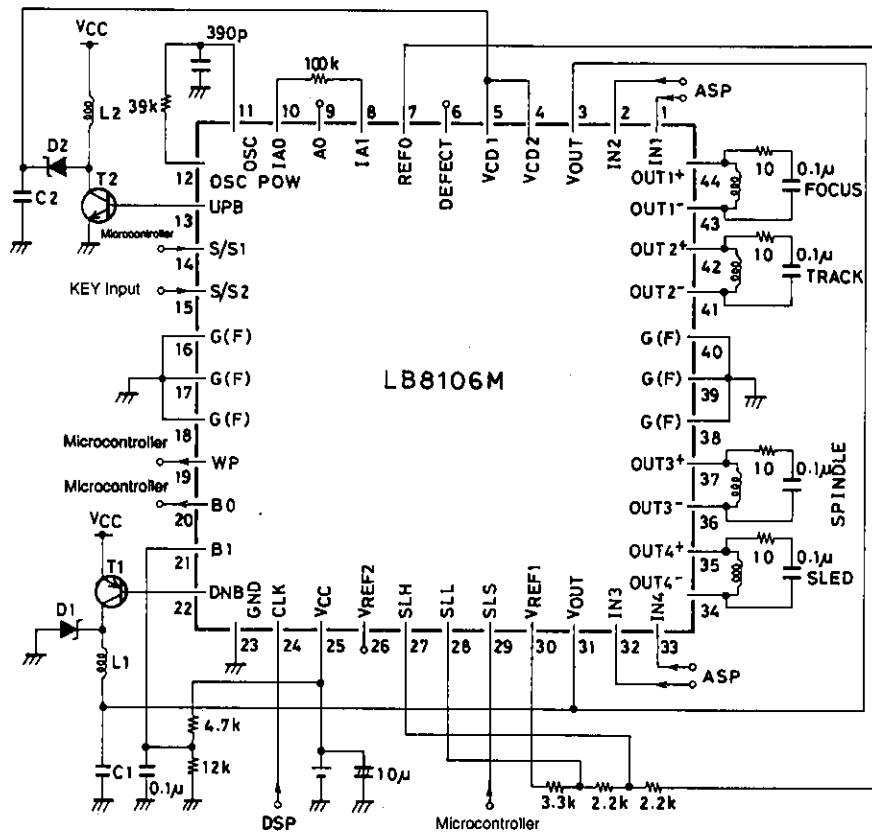

Unit (resistance: Ω, capacitance: F)

Notes

1. T1 is a 2SB815, T2 is a 2SC3650, D1 and D2 are SB07-03Cs, L1 = L2 = 30 μH and C1 = C2 = 100 μF.
2. Values shown are for reference only.
3. When using a digital spindle servomotor, connect the PWM output to IAI, set the integration constant using external components and connect AO to the spindle servomotor input.

LB8106M

Pin Functions

Number	Name	Equivalent circuit	Function
1	IN1		Focus actuator control input
2	IN2		Tracking actuator control input
3, 31	VOUT		Bridge driver outputs
4	VCD2		Up converter input
5	VCD1		Up converter input
6	DEFECT		Defect input
7	REFO		Sled drive reference voltage output
8	IAI		Integrating amplifier input
9	AO		Inverting amplifier output
10	IAO		Integrating amplifier output
11	OSC		Oscillator input
12	OSCPW		Oscillator supply output
13	UPB		Up converter npn-transistor driver output
14	SS1		System startup input 1
15	SS2		System startup input 2
16, 17, 18, 38, 39, 40	FGND		Frame ground

LB8106M

Number	Name	Equivalent circuit	Function
19	WP		Microcomputer startup output
20	BO		Battery check output
21	BI		Battery check input
22	DNB		Down converter pnp-transistor driver output
23	GND		Signal ground
24	CLK		Clock input
25	VCC		2.4 V supply
26	VREF2		1.2 V reference voltage
27	SLH		Sled driver startup voltage adjustment input
28	SLL		Sled driver stop voltage adjustment input
29	SLS		Sled changeover input
30	VREF1		Actuator driver reference voltage input

LB8106M

Number	Name	Equivalent circuit	Function
32	IN3		Spindle actuator control input
33	IN4		Sled actuator control input
34	OUT4-		Negative sled actuator driver output
35	OUT4+		Positive sled actuator driver output
36	OUT3-		Negative spindle actuator driver output
37	OUT3+		Positive spindle actuator driver output
41	OUT2-		Negative tracking actuator driver output
42	OUT2+		Positive tracking actuator driver output
43	OUT1-		Negative focus actuator driver output
44	OUT1+		Positive focus actuator driver output

Specifications

Absolute Maximum Ratings

Parameter	Symbol	Ratings	Unit
Supply voltage	V _{CC}	7.0	V
Bridge driver output current	I _o	800	mA
Up converter output current	I _{CO}	150	mA
Power dissipation	P _D	800	mW
Operating temperature range	T _{opr}	-20 to +75	°C
Storage temperature range	T _{stg}	-40 to +125	°C

Recommended Operating Conditions

T_a = 25 °C

Parameter	Symbol	Ratings	Unit
Supply voltage	V _{CC}	2.4	V
Supply voltage range	V _{CC}	2.0 to 4.0	V

Electrical Characteristics

Power supply

V_{CC} = 2.4 V, T_a = 25 °C

Parameter	Symbol	Conditions	Ratings			Unit
			min	typ	max	
Standby current consumption	I _{CCO}	SS1 and SS2 are HIGH.	-	-	10	μA
Quiescent current consumption	I _{CCQ}		-	18	27	mA
Power consumption	P _D		-	150	-	mW

Up converter $V_{DD} = 2.4 \text{ V}$, $T_a = 25 \text{ }^\circ\text{C}$

Parameter	Symbol	Conditions	Ratings			Unit
			min	typ	max	
Output voltage	V_{CD}		3.7	3.9	4.1	V
npn-transistor drive current	I_{no}		-	3.0	-	mA
Load characteristics	$\Delta V_{CD}/I_{CD}$		-	-	0.01	%/mA
Voltage characteristic	$\Delta V_{CD}/V_{CC}$		-	-	100	mV/V
Duty cycle	Duty		-	50	-	%

Oscillator $V_{DD} = 2.4 \text{ V}$, $T_a = 25 \text{ }^\circ\text{C}$

Parameter	Symbol	Conditions	Ratings			Unit
			min	typ	max	
Synchronizing signal input frequency	f_{syno}		80	-	100	kHz
OSCPOW output voltage	V_{OSCP}		$V_{CC} - 0.15$	-	-	V
OSC bias current	I_{BOSC}		-	-	-1.5	μA

H bridge $V_{DD} = 2.4 \text{ V}$, $T_a = 25 \text{ }^\circ\text{C}$

Parameter	Symbol	Conditions	Ratings			Unit
			min	typ	max	
Output saturation voltage	$V_{CE(sat)}$	$I_o = 200 \text{ mA}$, sink + source	-	0.26	0.39	V

Actuator drivers $V_{DD} = 2.4 \text{ V}$, $T_a = 25 \text{ }^\circ\text{C}$

Parameter	Symbol	Conditions	Ratings			Unit
			min	typ	max	
Input voltage	V_I	$V_{REF1} = 1/2 V_{CD}$	$V_{REF1} - 1.0$	V_{REF1}	$V_{REF1} + 1.0$	V
Input bias current	I_{BDR}		-	1.0	-	μA
Transmission voltage gain	G_{VTR}		-	7.95	-	dB
Single-channel transmission voltage gain differential	ΔG_{VTR}		-	± 1.0	-	dB
Dead band input voltage	V_{dx}		-	-	$V_{REF1} \pm 100$	mV
Dead band input voltage offset	V_{dzo}	Positive/inverse channel	-10	0	10	mV

PWM $V_{DD} = 2.4 \text{ V}$, $T_a = 25 \text{ }^\circ\text{C}$

Parameter	Symbol	Conditions	Ratings			Unit
			min	typ	max	
Maximum output voltage	V_O		2.1	2.4	2.7	V
pnp-transistor drive current	I_{PI}	See note.	–	$V_{OUT}/600$	–	mA
Load characteristic	$\Delta V_O/I_{LD}$		–	–	0.03	%/mA
Voltage characteristics	$\Delta V_O/V_{CC}$		–	–	50	mVV

Note

This parameter is guaranteed by the design and is not tested.

Sled driver $V_{DD} = 2.4 \text{ V}$, $T_a = 25 \text{ }^\circ\text{C}$

Parameter	Symbol	Conditions	Ratings			Unit
			min	typ	max	
Driver reference voltage	V_{REF0}		–	$V_{REF1} + 0.7$	–	V

Step mode $V_{DD} = 2.4 \text{ V}$, $T_a = 25 \text{ }^\circ\text{C}$

Parameter	Symbol	Conditions	Ratings			Unit
			min	typ	max	
SLS ON voltage	V_{SLSON}		2.0	–	–	V
SLL bias current	I_{BSLL}		–	–	300	μA
SLH bias current	I_{BSLH}		–	–	300	μA
DEFECT ON-voltage	V_{DEFON}		2.0	–	–	V

System startup and stop $V_{DD} = 2.4 \text{ V}$, $T_a = 25 \text{ }^\circ\text{C}$

Parameter	Symbol	Conditions	Ratings			Unit
			min	typ	max	
SS1 and SS2 LOW-level input voltage	V_{SSL}		–	–	$V_{CC} - 1.0$	V
SS1 and SS2 HIGH-level input voltage	V_{SSH}		$V_{CC} - 0.5$	–	–	V

Reference voltage $V_{DD} = 2.4 \text{ V}$, $T_a = 25 \text{ }^\circ\text{C}$

Parameter	Symbol	Conditions	Ratings			Unit
			min	typ	max	
REFO output current	I_{REFO}		–	–	100	μA
REF2 output voltage	V_{REF2}		–	1.2	–	V

Microcomputer startup

$V_{DD} = 2.4 \text{ V}$, $T_a = 25 \text{ }^\circ\text{C}$

Parameter	Symbol	Conditions	Ratings			Unit
			min	typ	max	
WP output voltage	V_{WP}		$V_{CD1} - 0.5$	-	-	V

Battery check

$V_{DD} = 2.4 \text{ V}$, $T_a = 25 \text{ }^\circ\text{C}$

Parameter	Symbol	Conditions	Ratings			Unit
			min	typ	max	
BI input bias current	I_{BI}		-	-	1.5	μA
BO output voltage	V_{BO}	$I_{BO} = 500 \mu\text{A}$	-	-	0.3	V

Clock

$V_{DD} = 2.4 \text{ V}$, $T_a = 25 \text{ }^\circ\text{C}$

Parameter	Symbol	Conditions	Ratings			Unit
			min	typ	max	
CLK input voltage	V_{CLK}		2	-	-	V

Integrating amplifier

$V_{DD} = 2.4 \text{ V}$, $T_a = 25 \text{ }^\circ\text{C}$

Parameter	Symbol	Conditions	Ratings			Unit
			min	typ	max	
Input bias current	I_{BIA1}		-	-	500	nA
First stage open loop voltage gain	G_{V1}	$f = 1 \text{ kHz}$. See note.	-	55	-	dB
Second stage closed loop voltage gain	G_{V2}		-	0	-	dB
First stage output saturation voltage	V_{O1}	1 mA source	$V_{CD} - 1.3$	-	-	V
		1 mA sink	-	-	1.3	
Second stage output saturation voltage	V_{O2}	1 mA source	$V_{CD} - 1.3$	-	-	V
		1 mA sink	-	-	1.3	

Note

This parameter is guaranteed by the design and is not tested.

Typical Performance Characteristics

Power dissipation vs. ambient temperature

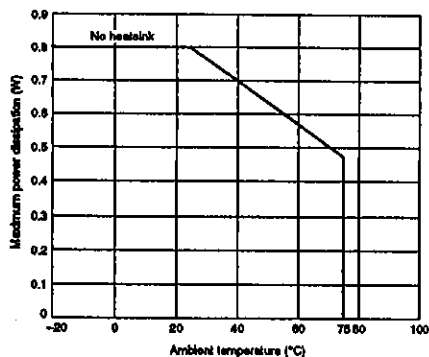

Functional Description

Focus, Tracking, Spindle and Sled Actuator Drivers

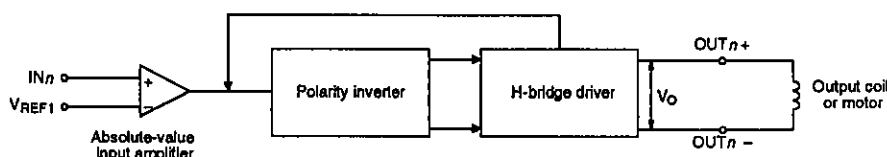

The reference voltage, V_{REF1} , from the CD player's DSP, is boosted to 3.9 V ($1/2 V_{CD2}$). The actuator's voltage characteristic is shown in the following figure.

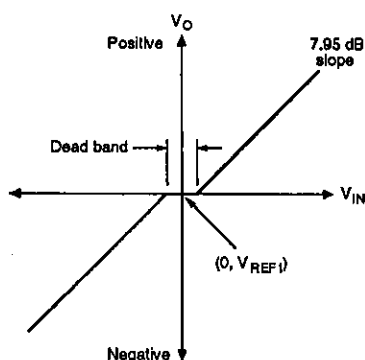

The V-type actuator driver, using V_{REF1} as a reference, generates a reverse polarity output. Note that there is a dead band in the range $V_I = V_{REF1} \pm 100$ mV (max) where V_O remains constant. The driver also incorporates a feedback loop for accurate gain.

Sled Actuator Driver Step Mode

In normal operating mode, the sled actuator driver functions as described in the previous section. When SLS is LOW, however, the sled actuator driver is in step mode, and the drive current is reduced.

The sled actuator control input signal is obtained by integrating the tracking output. The sled actuator starts and stops when this signal crosses thresholds determined by the external resistors connected between REF1 and REFO as shown in the following figure.

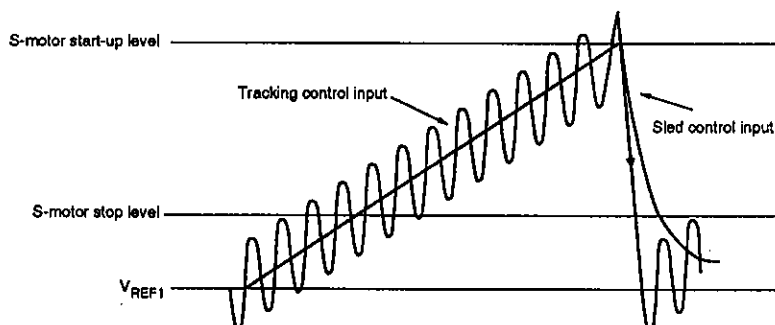

The voltage characteristic of the sled actuator driver in step mode is shown in the following figure. In step mode, maximum voltage is applied to the H-bridge. Note that the control input is usually lower than V_{REF1} .

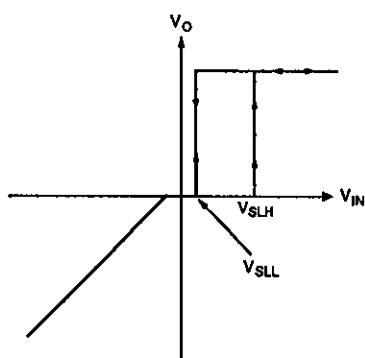

Up Converter

The up converter steps up the supply voltage for the control of each of the four actuator drivers. These drivers can also be powered externally from a supply with $V_{DD} = 3.9$ V (typ) and $I_O = 150$ mA (max).

At system startup, the up converter operates at the free-running frequency of the built-in oscillator. The oscillator's free-running frequency is determined by the capacitor and resistor connected to OSCPOW. If $R = 30$ k Ω and $C = 400$ pF, then the oscillator frequency is approximately 80 kHz.

After system startup, the oscillator synchronizes to the external clock, CLK. The external clock frequency must be in the range 80 to 100 kHz. Note that 88.2 kHz is the optimum frequency.

The oscillator duty cycle is limited to 50% (max), protecting the output transistor under heavy load. For

maximum efficiency, an output transistor with a high h_{FE} and a Schottky diode are recommended.

PWM Power Supply

To maximize power efficiency, the LB8106M uses a PWM power supply for the H-bridge drivers. The output voltage of the absolute value amplifier for each actuator driver is summed with an offset voltage and then applied to each H-bridge after PWM switching. If actuator operating voltages are similar and small, the actuators use a minimum of power. Also, only one inductor and capacitor are needed for all four actuator drivers.

Since the actuator drivers are linear, output noise is minimized. 2.4 V (typ) is supplied to the H-bridges and this is only prone to small variation with fluctuations in the supply voltage.

When DEFECT is HIGH, indicating the presence of a fault on the disk, or when the sled actuator driver is in step mode, the supply to each H-bridge is at maximum.

System Startup and Stop

The LB8106M can start and stop the system through connection to a microcomputer.

Setting SS1 LOW turns system power ON and sets WP HIGH. SS2 activates the key inputs and is ORed with SS1.

Setting both SS1 and SS2 HIGH, puts the power supply in standby mode.

The output characteristic of the absolute value amplifier is shown in the following figure.

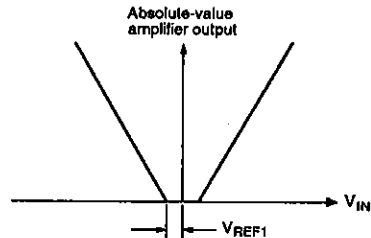

V_{CD} powers the integrating amplifier, the inverting amplifier, the sled actuator driver mode change circuit and the PWM power circuit. V_{CC} powers the rest of the circuits, including the up converter, the down converter, the reference voltage regulator, the battery checker and the oscillator.

- No products described or contained herein are intended for use in surgical implants, life-support systems, aerospace equipment, nuclear power control systems, vehicles, disaster/crime-prevention equipment and the like, the failure of which may directly or indirectly cause injury, death or property loss.
- Anyone purchasing any products described or contained herein for an above-mentioned use shall:
 - ① Accept full responsibility and indemnify and defend SANYO ELECTRIC CO., LTD., its affiliates, subsidiaries and distributors and all their officers and employees, jointly and severally, against any and all claims and litigation and all damages, cost and expenses associated with such use:
 - ② Not impose any responsibility for any fault or negligence which may be cited in any such claim or litigation on SANYO ELECTRIC CO., LTD., its affiliates, subsidiaries and distributors or any of their officers and employees jointly or severally.
- Information (including circuit diagrams and circuit parameters) herein is for example only; it is not guaranteed for volume production. SANYO believes information herein is accurate and reliable, but no guarantees are made or implied regarding its use or any infringements of intellectual property rights or other rights of third parties.