

## *Advance Information* **Low Voltage 1:18 Clock Distribution Chip**

The MPC940L is a 1:18 low voltage clock distribution chip with 2.5V LVCMOS output capabilities. The device features the capability to select either a differential LVPECL or an LVTTTL/ LVCMOS compatible input. The 18 outputs are 2.5V LVCMOS compatible and feature the drive strength to drive 50Ω series or parallel terminated transmission lines. With output-to-output skews of 150ps, the MPC940L is ideal as a clock distribution chip for the most demanding of synchronous systems. The 2.5V outputs also make the device ideal for supplying clocks for a high performance Pentium II™ microprocessor based design.

- LVPECL or LVCMOS/LVTTTL Clock Input
- 2.5V LVCMOS Outputs for Pentium II Microprocessor Support
- 150ps Maximum Targeted Output-to-Output Skew
- Maximum Output Frequency of 250MHz
- 32-Lead TQFP Packaging
- Dual V<sub>CC</sub> Supply Voltage, 3.3V Core and 2.5V Output

With a low output impedance ( $\approx 30\Omega$ ), in both the HIGH and LOW logic states, the output buffers of the MPC940L are ideal for driving series terminated transmission lines. With this drive capability, the MPC940L provides enough copies of low skew clocks for most high performance synchronous systems.

The differential LVPECL inputs of the MPC940L allow the device to interface directly with a LVPECL fanout buffer like the MC100EP111 to build very wide clock fanout trees or to couple to a high frequency clock source. The LVCMOS/LVTTTL input provides a more standard interface for applications requiring only a single clock distribution chip at relatively low frequencies. In addition, the two clock sources can be used to provide for a test clock interface as well as the primary system clock. A logic HIGH on the LVCMOS\_CLK\_Sel pin will select the TTL level clock input.

The MPC940L is a dual supply device. The core V<sub>CC</sub> power pins (VCCI) require 3.3V with the output V<sub>CC</sub> pins (VCCO) requiring 2.5V. The 32-lead TQFP package was chosen to optimize performance, board space and cost of the device. The 32-lead TQFP has a 7x7mm body size with a conservative 0.8mm pin spacing.

**MPC940L**

**LOW VOLTAGE  
1:18 CLOCK  
DISTRIBUTION CHIP**



**FA SUFFIX**  
32-LEAD TQFP PACKAGE  
CASE 873A-02

Pentium II is a trademark of Intel Corporation.

This document contains information on a new product. Specifications and information herein are subject to change without notice.



**LOGIC DIAGRAM**



**Pinout: 32-Lead TQFP (Top View)**

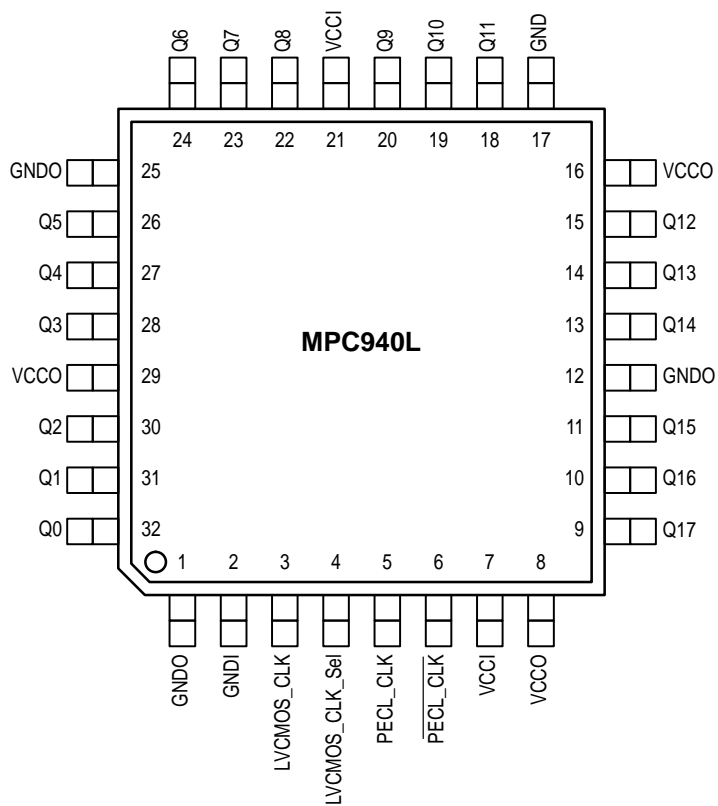

**FUNCTION TABLE**

LVC MOS_CLK_Sel	Input
0	PECL_CLK
1	LVC MOS_CLK

**POWER SUPPLY VOLTAGES**

Supply Pin	Voltage Level
VCCI	3.3V ± 5%
VCCO	2.5V ± 5%

**ABSOLUTE MAXIMUM RATINGS\***

Symbol	Parameter	Min	Max	Unit
V <sub>CC</sub>	Supply Voltage	-0.3	3.6	V
V <sub>I</sub>	Input Voltage	-0.3	V <sub>DD</sub> + 0.3	V
I <sub>IN</sub>	Input Current		±20	mA
T <sub>Stor</sub>	Storage Temperature Range	-40	125	°C

\* Absolute maximum continuous ratings are those values beyond which damage to the device may occur. Exposure to these conditions or conditions beyond those indicated may adversely affect device reliability. Functional operation under absolute-maximum-rated conditions is not implied.

**DC CHARACTERISTICS** (T<sub>A</sub> = 0° to 70°C, V<sub>CCI</sub> = 3.3V ±5%; V<sub>CCO</sub> = 2.5V ±5%)

Symbol	Characteristic	Min	Typ	Max	Unit	Condition
V <sub>IH</sub>	Input HIGH Voltage PECL_CLK Other	2.135 2.0		2.42 3.60	V	
V <sub>IL</sub>	Input LOW Voltage PECL_CLK Other	1.49		1.825 0.8	V	
V <sub>PP</sub>	Peak-to-Peak Input Voltage PECL_CLK	300		1000	mV	
V <sub>CMR</sub>	Common Mode Range PECL_CLK	V <sub>CC</sub> -1.6		V <sub>CC</sub> -0.6	V	
V <sub>OH</sub>	Output HIGH Voltage	2.5			V	I <sub>OH</sub> = -16mA, Note 1.
V <sub>OL</sub>	Output LOW Voltage			0.5	V	I <sub>OH</sub> = 16mA, Note 1.
I <sub>IN</sub>	Input Current			±100	μA	
C <sub>IN</sub>	Input Capacitance			4	pF	
C <sub>pd</sub>	Power Dissipation Capacitance		8		pF	Per Output
I <sub>CC</sub>	Maximum Quiescent Supply Current I <sub>CC</sub> L I <sub>CC</sub> H		70 140		mA	

1. The MPC940L outputs can drive series or parallel terminated 50Ω (or 50Ω to V<sub>CC</sub>/2) transmission lines on the incident edge.

**AC CHARACTERISTICS** (T<sub>A</sub> = 0° to 70°C, V<sub>CCI</sub> = 3.3V ±5%; V<sub>CCO</sub> = 2.5V ±5%)

Symbol	Characteristic	Min	Typ	Max	Unit	Condition
F <sub>max</sub>	Maximum Input Frequency		250		MHz	Note 1.
t <sub>pd</sub>	Propagation Delay PECL_CLK to Q TTL_CLK to Q		2.0 2.3		ns	Note 1.
t <sub>sk(o)</sub>	Output-to-Output Skew			150	ps	Note 1.
t <sub>sk(pr)</sub>	Part-to-Part Skew PECL_CLK to Q TTL_CLK to Q		800 800		ps	Notes 2., 3.
t <sub>pwo</sub>	Output Pulse Width	45		55	p%	Note 1., Measured at V <sub>CC</sub> /2
t <sub>r</sub> , t <sub>f</sub>	Output Rise/Fall Time	0.20		1.0	ns	0.8V to 2.0V

- Driving 50Ω transmission lines
- Part-to-part skew at a given temperature and voltage
- Final specification limits will be determined from matrix lot material. 800ps is the "best estimate" based on initial material and experience with previous products.

OUTLINE DIMENSIONS

FA SUFFIX  
TQFP PACKAGE  
CASE 873A-02  
ISSUE A

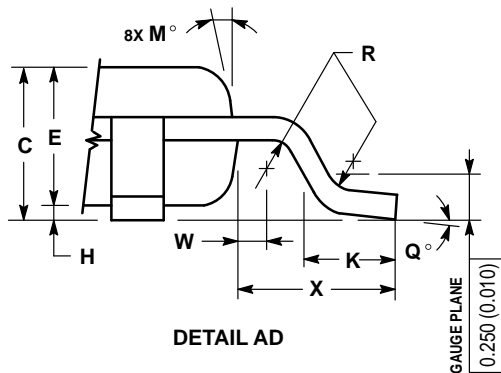
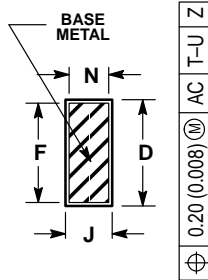
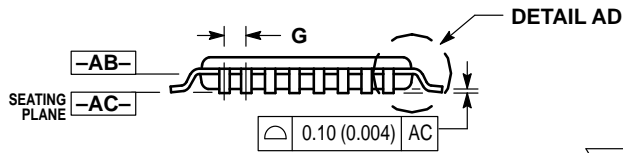
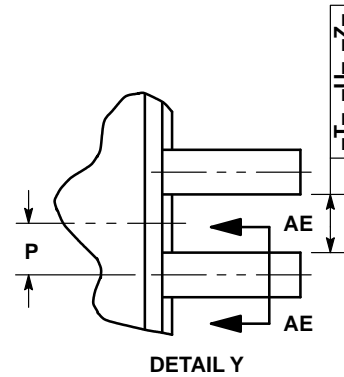
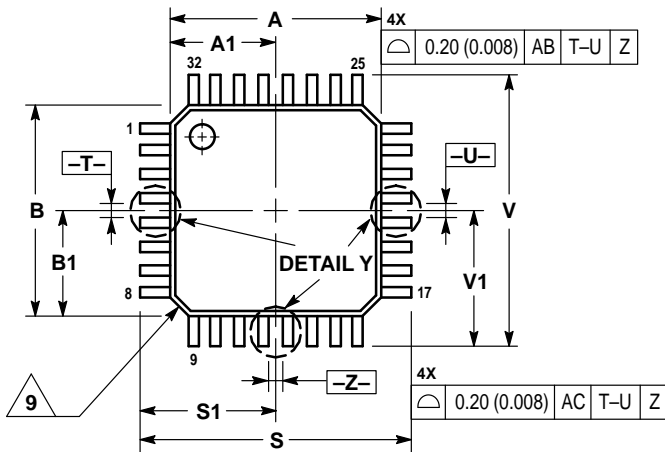

NOTES:

1. DIMENSIONING AND TOLERANCING PER ANSI Y14.5M, 1982.
2. CONTROLLING DIMENSION: MILLIMETER.
3. DATUM PLANE -AB- IS LOCATED AT BOTTOM OF LEAD AND IS COINCIDENT WITH THE LEAD WHERE THE LEAD EXITS THE PLASTIC BODY AT THE BOTTOM OF THE PARTING LINE.
4. DATUMS -T-, -U-, AND -Z- TO BE DETERMINED AT DATUM PLANE -AB-.
5. DIMENSIONS S AND V TO BE DETERMINED AT SEATING PLANE -AC-.
6. DIMENSIONS A AND B DO NOT INCLUDE MOLD PROTRUSION. ALLOWABLE PROTRUSION IS 0.250 (0.010) PER SIDE. DIMENSIONS A AND B DO INCLUDE MOLD MISMATCH AND ARE DETERMINED AT DATUM PLANE -AB-.
7. DIMENSION D DOES NOT INCLUDE DAMBAR PROTRUSION. DAMBAR PROTRUSION SHALL NOT CAUSE THE D DIMENSION TO EXCEED 0.520 (0.020).
8. MINIMUM SOLDER PLATE THICKNESS SHALL BE 0.0076 (0.0003).
9. EXACT SHAPE OF EACH CORNER MAY VARY FROM DEPICTION.

DIM	MILLIMETERS		INCHES	
	MIN	MAX	MIN	MAX
A	7.000 BSC		0.276 BSC	
A1	3.500 BSC		0.138 BSC	
B	7.000 BSC		0.276 BSC	
B1	3.500 BSC		0.138 BSC	
C	1.400	1.600	0.055	0.063
D	0.300	0.450	0.012	0.018
E	1.350	1.450	0.053	0.057
F	0.300	0.400	0.012	0.016
G	0.800 BSC		0.031 BSC	
H	0.050	0.150	0.002	0.006
J	0.090	0.200	0.004	0.008
K	0.500	0.700	0.020	0.028
M	12° REF		12° REF	
N	0.090	0.160	0.004	0.006
P	0.400 BSC		0.016 BSC	
Q	1°	5°	1°	5°
R	0.150	0.250	0.006	0.010
S	9.000 BSC		0.354 BSC	
S1	4.500 BSC		0.177 BSC	
V	9.000 BSC		0.354 BSC	
V1	4.500 BSC		0.177 BSC	
W	0.200 REF		0.008 REF	
X	1.000 REF		0.039 REF	

Motorola reserves the right to make changes without further notice to any products herein. Motorola makes no warranty, representation or guarantee regarding the suitability of its products for any particular purpose, nor does Motorola assume any liability arising out of the application or use of any product or circuit, and specifically disclaims any and all liability, including without limitation consequential or incidental damages. "Typical" parameters which may be provided in Motorola data sheets and/or specifications can and do vary in different applications and actual performance may vary over time. All operating parameters, including "Typicals" must be validated for each customer application by customer's technical experts. Motorola does not convey any license under its patent rights nor the rights of others. Motorola products are not designed, intended, or authorized for use as components in systems intended for surgical implant into the body, or other applications intended to support or sustain life, or for any other application in which the failure of the Motorola product could create a situation where personal injury or death may occur. Should Buyer purchase or use Motorola products for any such unintended or unauthorized application, Buyer shall indemnify and hold Motorola and its officers, employees, subsidiaries, affiliates, and distributors harmless against all claims, costs, damages, and expenses, and reasonable attorney fees arising out of, directly or indirectly, any claim of personal injury or death associated with such unintended or unauthorized use, even if such claim alleges that Motorola was negligent regarding the design or manufacture of the part. Motorola and  are registered trademarks of Motorola, Inc. Motorola, Inc. is an Equal Opportunity/Affirmative Action Employer.

Mfax is a trademark of Motorola, Inc.

**How to reach us:**

**USA/EUROPE/Locations Not Listed:** Motorola Literature Distribution;  
P.O. Box 5405, Denver, Colorado 80217. 303-675-2140 or 1-800-441-2447

**JAPAN:** Nippon Motorola Ltd.: SPD, Strategic Planning Office, 4-32-1,  
Nishi-Gotanda, Shinagawa-ku, Tokyo 141, Japan. 81-3-5487-8488

**Mfax™:** RMFAX0@email.sps.mot.com – TOUCHTONE 602-244-6609  
– US & Canada ONLY 1-800-774-1848

**ASIA/PACIFIC:** Motorola Semiconductors H.K. Ltd.; 8B Tai Ping Industrial Park,  
51 Ting Kok Road, Tai Po, N.T., Hong Kong. 852-26629298

**INTERNET:** <http://motorola.com/sps>

