

**Rectifier diodes
Schottky barrier**

PBYR7025WT series

FEATURES

- Low forward volt drop
- Fast switching
- Reverse surge capability
- High thermal cycling performance
- Low thermal resistance

SYMBOL

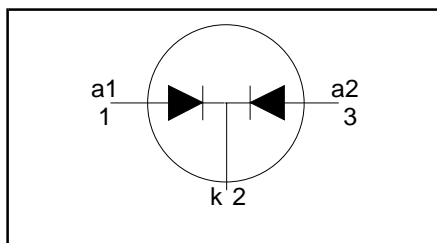

QUICK REFERENCE DATA

| |
|-----------------------------------|
| $V_R = 20\text{ V} / 25\text{ V}$ |
| $I_{O(AV)} = 70\text{ A}$ |
| $V_F \leq 0.46\text{ V}$ |

GENERAL DESCRIPTION

Dual, common cathode schottky rectifier diodes in a plastic envelope. Intended for use as output rectifiers in low voltage, high frequency switched mode power supplies.

The PBYR7025WT series is supplied in the conventional leaded SOT429 (TO247) package.

PINNING

| PIN | DESCRIPTION |
|-----|-------------|
| 1 | anode 1 (a) |
| 2 | cathode (k) |
| 3 | anode 2 (a) |
| tab | cathode |

SOT429 (TO247)

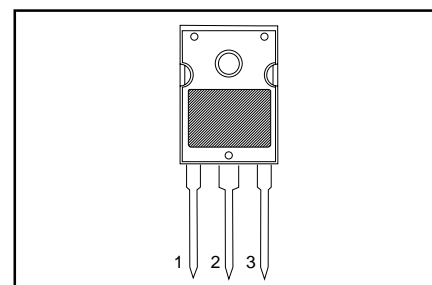

LIMITING VALUES

Limiting values in accordance with the Absolute Maximum System (IEC 134).

| SYMBOL | PARAMETER | CONDITIONS | MIN. | MAX. | | UNIT |
|-------------|---|---|------|------|-----|------|
| | | | | -20 | -25 | |
| V_{RRM} | Repetitive peak reverse voltage | $T_{mb} \leq 116\text{ °C}$ | - | 20 | 25 | V |
| V_{RWM} | Crest working reverse voltage | | - | 20 | 25 | V |
| V_R | Continuous reverse voltage | | - | 20 | 25 | V |
| $I_{O(AV)}$ | Average output current (both diodes conducting) | square wave; $\delta = 0.5$; $T_{mb} \leq 114\text{ °C}$ | - | 70 | | A |
| I_{FRM} | Repetitive peak forward current per diode | $t = 25\text{ }\mu\text{s}$; $\delta = 0.5$; $T_{mb} \leq 114\text{ °C}$ | - | 70 | | A |
| I_{FSM} | Non-repetitive peak forward current, per diode | $t = 10\text{ ms}$ $t = 8.3\text{ ms}$ sinusoidal $T_j = 125\text{ °C}$ prior to surge; with reapplied $V_{RRM(max)}$ | - | 500 | 550 | A |
| I_{RRM} | Repetitive peak reverse current per diode | $t_p = 2\text{ }\mu\text{s}$; $\delta = 0.001$ | - | 2 | | A |
| I_{RSM} | Non-repetitive peak reverse current per diode | $t_p = 100\text{ }\mu\text{s}$ | - | 2 | | A |
| T_{stg} | Storage temperature | | -65 | 150 | | °C |
| T_j | Operating junction temperature | | - | 150 | | °C |

THERMAL RESISTANCES

| SYMBOL | PARAMETER | CONDITIONS | MIN. | TYP. | MAX. | UNIT |
|----------------|--|----------------------------|------|------|------|------|
| $R_{th\ j-mb}$ | Thermal resistance junction to mounting base | per diode | - | - | 0.9 | K/W |
| $R_{th\ j-a}$ | Thermal resistance junction to ambient | both diodes in free air | - | 45 | 0.65 | K/W |
| | | | | | - | K/W |

 Rectifier diodes
 Schottky barrier

 PBYR7025WT series

ELECTRICAL CHARACTERISTICS
 $T_j = 25\text{ °C}$ unless otherwise stated

| SYMBOL | PARAMETER | CONDITIONS | MIN. | TYP. | MAX. | UNIT |
|--------|----------------------------------|--|------|------|------|------|
| V_F | Forward voltage (per diode) | $I_F = 35\text{ A}; T_j = 125\text{ °C}$ | - | 0.40 | 0.46 | V |
| | | $I_F = 70\text{ A}; T_j = 125\text{ °C}$ | - | 0.52 | 0.54 | V |
| | | $I_F = 70\text{ A}$ | - | 0.58 | 0.64 | V |
| I_R | Reverse current (per diode) | $V_R = V_{RRM}$ | - | 0.8 | 15 | mA |
| | | $V_R = V_{RRM}; T_j = 100\text{ °C}$ | - | 40 | 120 | mA |
| C_d | Junction capacitance (per diode) | $f = 1\text{ MHz}; V_R = 5\text{ V}; T_j = 25\text{ °C to } 125\text{ °C}$ | - | 2100 | - | pF |

Rectifier diodes
Schottky barrier

PBYR7025WT series

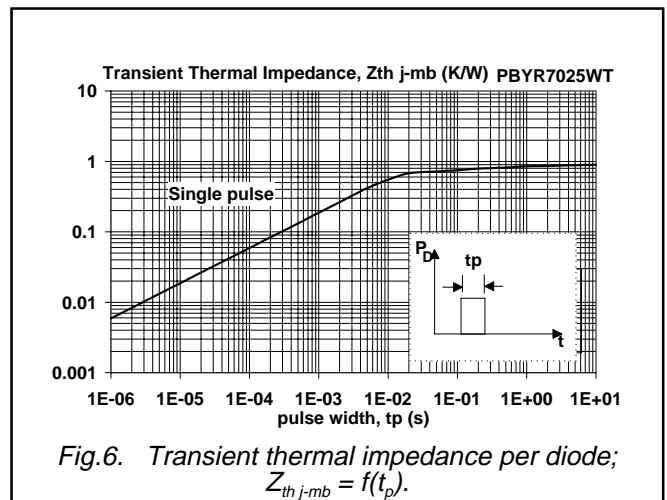
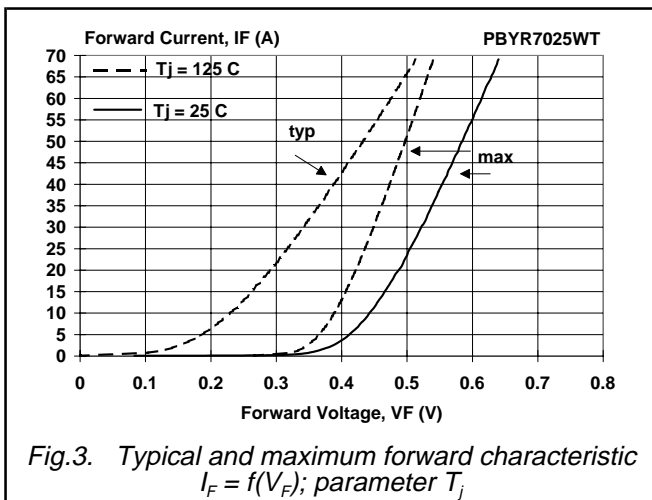
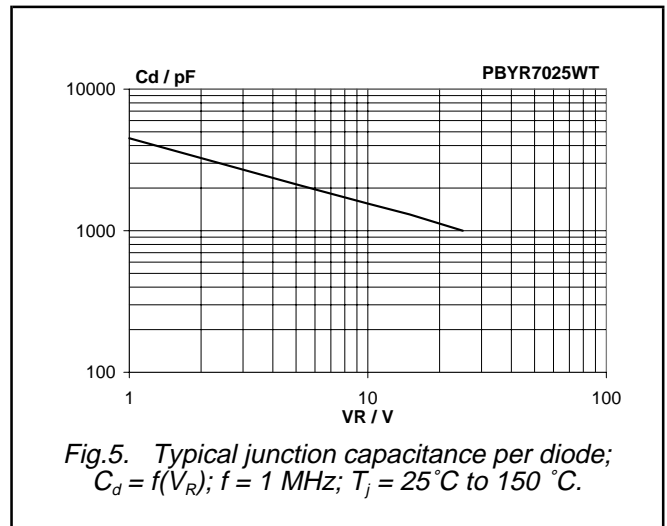
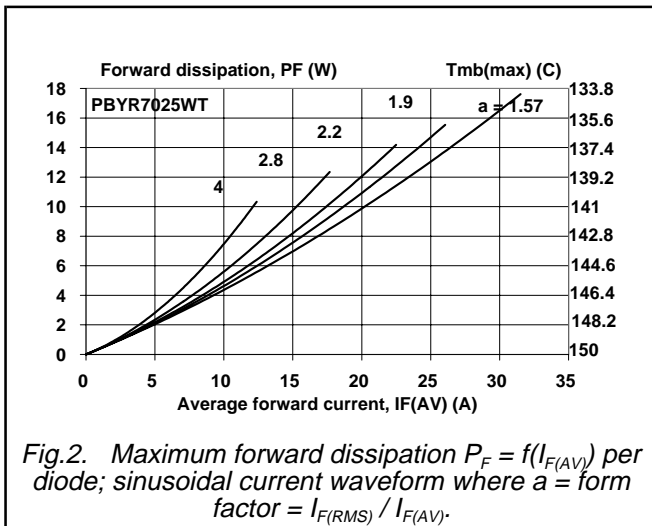
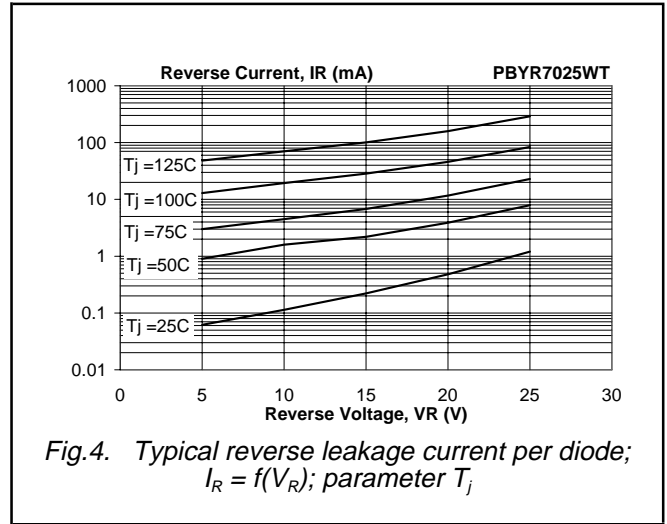
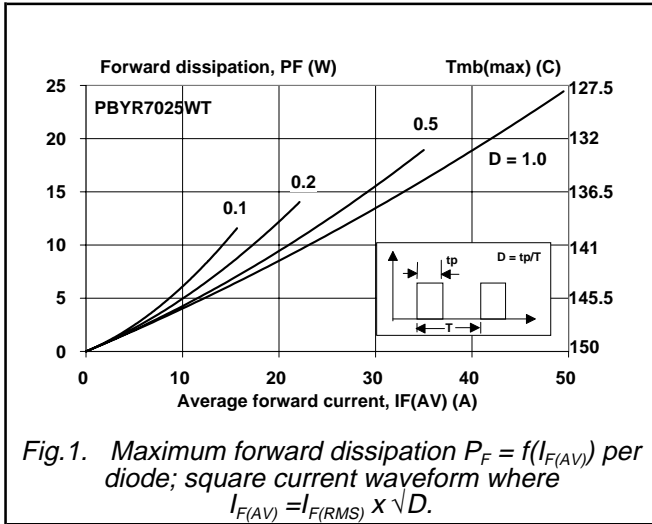

Rectifier diodes
Schottky barrier

PBYR7025WT series

MECHANICAL DATA

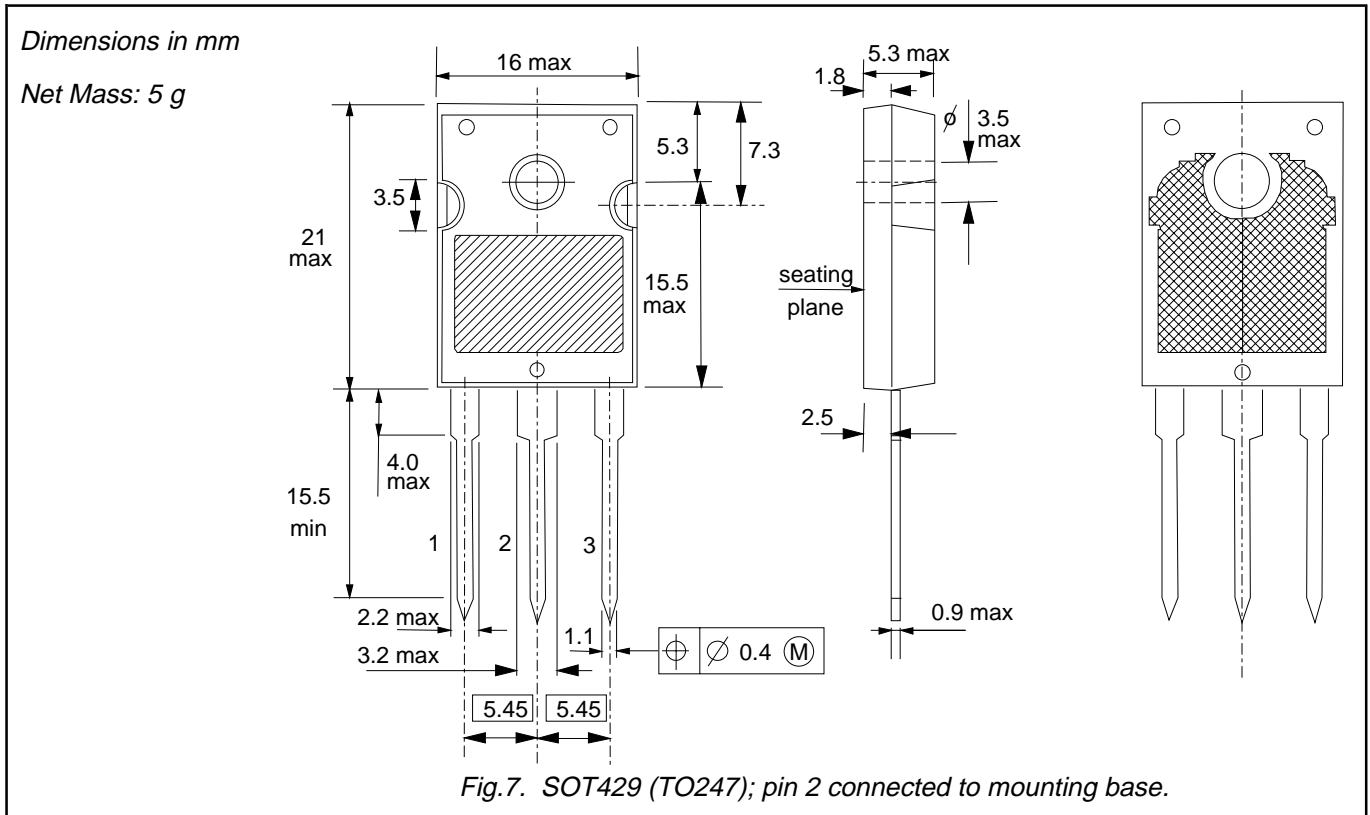

Notes

1. Refer to mounting instructions for SOT429 envelope.
2. Epoxy meets UL94 V0 at 1/8".

Rectifier diodes
Schottky barrier

PBYR7025WT series

DEFINITIONS

| | |
|--|---|
| Data sheet status | |
| Objective specification | This data sheet contains target or goal specifications for product development. |
| Preliminary specification | This data sheet contains preliminary data; supplementary data may be published later. |
| Product specification | This data sheet contains final product specifications. |
| Limiting values | |
| Limiting values are given in accordance with the Absolute Maximum Rating System (IEC 134). Stress above one or more of the limiting values may cause permanent damage to the device. These are stress ratings only and operation of the device at these or at any other conditions above those given in the Characteristics sections of this specification is not implied. Exposure to limiting values for extended periods may affect device reliability. | |
| Application information | |
| Where application information is given, it is advisory and does not form part of the specification. | |
| © Philips Electronics N.V. 1999 | |
| All rights are reserved. Reproduction in whole or in part is prohibited without the prior written consent of the copyright owner. | |
| The information presented in this document does not form part of any quotation or contract, it is believed to be accurate and reliable and may be changed without notice. No liability will be accepted by the publisher for any consequence of its use. Publication thereof does not convey nor imply any license under patent or other industrial or intellectual property rights. | |

LIFE SUPPORT APPLICATIONS

These products are not designed for use in life support appliances, devices or systems where malfunction of these products can be reasonably expected to result in personal injury. Philips customers using or selling these products for use in such applications do so at their own risk and agree to fully indemnify Philips for any damages resulting from such improper use or sale.