

EVALUATION KIT
AVAILABLE**MAXIM**

Single/Triple, Low-Glitch, 250MHz, Current-Feedback Amplifiers with High-Speed Disable

General Description

The MAX4188/MAX4189/MAX4190 are low-power, current-feedback video amplifiers featuring fast disable/enable times and low switching transients. The triple MAX4188 and the single MAX4190 are optimized for applications with closed-loop gains of +2V/V (6dB) or greater and provide a -3dB bandwidth of 200MHz and 185MHz, respectively. The triple MAX4189 is optimized for closed-loop applications with gains of +1V/V (0dB) or greater and provides a 250MHz -3dB bandwidth. These amplifiers feature 0.1dB gain flatness up to 80MHz with differential gain and phase errors of 0.03% and 0.05°. These features make the MAX4188 family ideal for video applications.

The MAX4188/MAX4189/MAX4190 operate from a +5V single supply or from $\pm 2.25V$ to $\pm 5.5V$ dual supplies. These amplifiers consume only 1.5mA per amplifier and are capable of delivering $\pm 55mA$ of output current, making them ideal for portable and battery-powered equipment.

The MAX4188/MAX4189/MAX4190 have a high-speed disable/enable mode that isolates the inputs, places the outputs in a high-impedance state, and reduces the supply current to 450 μA per amplifier. Each amplifier can be disabled independently. High off isolation, low switching transient, and fast enable/disable times (120ns/35ns) allow these amplifiers to be used in a wide range of multiplexer applications. A settling time of 22ns to 0.1%, a slew rate of up to 350V/ μs , and low distortion make these devices useful in many general-purpose, high-speed applications.

The MAX4188/MAX4189 are available in a tiny 16-pin QSOP package, and the MAX4190 is available in a space-saving 8-pin μMAX package.

Applications

High-Definition Surveillance Video
High-Speed Switching/Multiplexing
Portable/Battery-Powered Video/Multimedia Systems
High-Speed Analog-to-Digital Buffers
Medical Imaging
High-Speed Signal Processing
Professional Cameras
CCD Imaging Systems
RGB Distribution Amplifiers

Pin Configuration appears at end of data sheet.

Features

- ◆ **Low Supply Current: 1.5mA per Amplifier**
- ◆ **Fast Enable/Disable Times: 120ns/35ns**
- ◆ **Very Low Switching Transient: 45mV_{p-p}**
- ◆ **High Speed**
 - 200MHz -3dB Small-Signal Bandwidth (MAX4188, $A_{VCL} \geq +2$)**
 - 250MHz -3dB Small-Signal Bandwidth (MAX4189, $A_{VCL} \geq +1$)**
 - 185MHz -3dB Small-Signal Bandwidth (MAX4190, $A_{VCL} \geq +2$)**
- ◆ **High Slew Rate**
 - 350V/ μs (MAX4188, $A_{VCL} \geq +2$)**
 - 175V/ μs (MAX4189, $A_{VCL} \geq +1$)**
- ◆ **Excellent Video Specifications**
 - 85MHz -0.1dB Gain Flatness (MAX4190)**
 - 30MHz -0.1dB Gain Flatness (MAX4189)**
 - Differential Gain/Phase Errors 0.03%/0.05° (MAX4188)**
- ◆ **Low-Power Disable Mode**
 - Inputs Isolated, Outputs Placed in High-Z**
 - Supply Current Reduced to 450 μA per Amplifier**
- ◆ **Fast Settling Time of 22ns to 0.1%**
- ◆ **Low Distortion**
 - 70dB SFDR ($f_c = 5MHz$, $V_O = 2V_{p-p}$, MAX4188)**
- ◆ **Available in Space-Saving Packages**
 - 16-Pin QSOP (MAX4188/MAX4189)**
 - 8-Pin μMAX (MAX4190)**

Ordering Information

PART	TEMP. RANGE	PIN-PACKAGE
MAX4188ESD	-40°C to +85°C	14 SO
MAX4188EEE	-40°C to +85°C	16 QSOP

Ordering Information continued at end of data sheet.

Selector Guide

PART	OPTIMIZED FOR:	AMPLIFIERS PER PKG.	PIN-PACKAGE
MAX4188	$A_V \geq +2V/V$	3	14-pin SO, 16-pin QSOP
MAX4189	$A_V \geq +1V/V$	3	14-pin SO, 16-pin QSOP
MAX4190	$A_V \geq +2V/V$	1	8-pin $\mu MAX/SO$

MAXIM

Maxim Integrated Products 1

For free samples & the latest literature: <http://www.maxim-ic.com>, or phone 1-800-998-8800.
For small orders, phone 408-737-7600 ext. 3468.

MAX4188/MAX4189/MAX4190

Single/Triple, Low-Glitch, 250MHz, Current-Feedback Amplifiers with High-Speed Disable

ABSOLUTE MAXIMUM RATINGS

Supply Voltage (V_{CC} to V_{EE}).....	+12V	14-Pin SO (derate 8.3mW/°C above +70°C)	667mW
IN_+ , IN_- , $\overline{DISABLE}$ Voltage	($V_{EE} - 0.3V$) to ($V_{CC} + 0.3V$)	16-Pin QSOP (derate 8.3mW/°C above +70°C).....	667mW
Differential Input Voltage (IN_+ to IN_-).....	$\pm 1.5V$	Operating Temperature Range.....	-40°C to +85°C
Maximum Current into IN_+ or IN_-	$\pm 10mA$	Storage Temperature Range	-65°C to +150°C
Output Short-Circuit Current Duration.....	Continuous	Lead Temperature (soldering, 10sec)	+300°C
Continuous Power Dissipation ($T_A = +70^\circ C$)			
8-Pin SO (derate 5.88mW/°C above +70°C).....	471mW		
8-Pin μ MAX (derate 4.1mW/°C above +70°C)	330mW		

Stresses beyond those listed under "Absolute Maximum Ratings" may cause permanent damage to the device. These are stress ratings only, and functional operation of the device at these or any other conditions beyond those indicated in the operational sections of the specifications is not implied. Exposure to absolute maximum rating conditions for extended periods may affect device reliability.

DC ELECTRICAL CHARACTERISTICS—Dual Supplies

($V_{CC} = +5V$; $V_{EE} = -5V$; $IN_+ = 0$; $\overline{DISABLE} \geq 3.2V$; MAX4188: $A_V = +2V/V$, $R_F = R_G = 910\Omega$ for $R_L = 1k\Omega$ and $R_F = R_G = 560\Omega$ for $R_L = 150\Omega$; MAX4189: $A_V = +1V/V$, $R_F = 1600\Omega$ for $R_L = 1k\Omega$ and $R_F = 1100\Omega$ for $R_L = 150\Omega$; MAX4190: $A_V = +2V/V$, $R_F = R_G = 1300\Omega$ for $R_L = 1k\Omega$, $R_F = R_G = 680\Omega$ for $R_L = 150\Omega$; $T_A = T_{MIN}$ to T_{MAX} , unless otherwise noted. Typical values are specified at $T_A = +25^\circ C$.)

PARAMETER	SYMBOL	CONDITIONS	MIN	TYP	MAX	UNITS
Operating Supply Voltage		Inferred from PSRR tests	± 2.25		± 5.5	V
Input Voltage Range	V_{CM}	Guaranteed by CMRR test	± 3.1	± 3.4		V
Input Offset Voltage	V_{OS}	$V_{CM} = 0$ (Note 1)		± 1	± 6	mV
Input Offset Voltage Tempco	TC_{VOS}			± 10		$\mu V/^\circ C$
Input Offset Voltage Matching				± 1		mV
Input Bias Current (Positive Input)	I_{B+}			± 1	± 10	μA
Input Bias Current (Negative Input)	I_{B-}			± 2	± 12	μA
Input Resistance (Positive Input)	R_{IN+}	$-3.1V \leq V_{CM} \leq 3.1V$, $ V_{IN+} - V_{IN-} \leq 1V$	100	350		$k\Omega$
Input Resistance (Negative Input)	R_{IN-}			300		Ω
Input Capacitance (Positive Input)	C_{IN}			2.5		pF
Common-Mode Rejection Ratio	CMRR	$-3.1V \leq V_{CM} \leq 3.1V$	56	68		dB
Open-Loop Transresistance	T_R	$-3.1V \leq V_{OUT} \leq 3.1V$, $R_L = 1k\Omega$	1	7		$M\Omega$
		$-2.8V \leq V_{OUT} \leq 2.8V$, $R_L = 150\Omega$	0.3	2		
Output Voltage Swing	V_{SW}	$R_L = 1k\Omega$	± 3.5	± 4.0		V
		$R_L = 150\Omega$	± 3.0	± 3.3		
Output Current	I_{OUT}	$R_L = 30\Omega$	± 20	± 55		mA
Output Short-Circuit Current	I_{SC}			± 60		mA
Output Resistance	R_{OUT}			0.2		Ω
Disabled Output Leakage Current	$I_{OUT(OFF)}$	$\overline{DISABLE} \leq V_{IL}$, $V_{OUT} \leq \pm 3.5V$ (Note 2)		± 0.8	± 5	μA
Disabled Output Capacitance	$C_{OUT(OFF)}$	$\overline{DISABLE} \leq V_{IL}$, $V_{OUT} \leq \pm 3.5V$		5		pF
$\overline{DISABLE}$ Low Threshold	V_{IL}	(Note 3)			$V_{CC} - 3$	V
$\overline{DISABLE}$ High Threshold	V_{IH}	(Note 3)	$V_{CC} - 1.8$			V
$\overline{DISABLE}$ Input Current	I_{IN}	$V_{EE} \leq \overline{DISABLE} \leq V_{CC}$		0.1	2	μA
Power-Supply Rejection Ratio (V_{CC})	PSRR+	$V_{EE} = -5V$, $V_{CC} = 4.5V$ to $5.5V$	60	75		dB
Power-Supply Rejection Ratio (V_{EE})	PSRR-	$V_{CC} = 5V$, $V_{EE} = -4.5V$ to $-5.5V$	60	73		dB
Quiescent Supply Current (per Amplifier)	I_S	$R_L = open$		1.5	1.85	mA
Disabled Supply Current (per Amplifier)	$I_{S(OFF)}$	$\overline{DISABLE} \leq V_{IL}$, $R_L = open$		0.45	0.65	mA

Single/Triple, Low-Glitch, 250MHz, Current-Feedback Amplifiers with High-Speed Disable

MAX4188/MAX4189/MAX4190

DC ELECTRICAL CHARACTERISTICS—Single Supply

($V_{CC} = +5V$; $V_{EE} = 0$; $I_{IN+} = 2.5V$; $\overline{DISABLE}_- \geq 3.2V$; R_L to $V_{CC} / 2$; MAX4188: $A_V = +2V/V$, $R_F = R_G = 1.1k\Omega$ for $R_L = 1k\Omega$ and $R_F = R_G = 620\Omega$ for $R_L = 150\Omega$; MAX4189: $A_V = +1V/V$, $R_F = 1500\Omega$ for $R_L = 1k\Omega$ and $R_F = 1600\Omega$ for $R_L = 150\Omega$; MAX4190: $A_V = +2V/V$, $R_F = R_G = 1300\Omega$ for $R_L = 1k\Omega$, $R_F = R_G = 680\Omega$ for $R_L = 150\Omega$; $T_A = T_{MIN}$ to T_{MAX} , unless otherwise noted. Typical values are specified at $T_A = +25^\circ C$.)

PARAMETER	SYMBOL	CONDITIONS	MIN	TYP	MAX	UNITS
Operating Supply Voltage		Inferred from PSRR tests	4.5		5.5	V
Input Voltage Range	V_{CM}	Guaranteed by CMRR test	1.6 to 3.4	1.3 to 3.7		V
Input Offset Voltage	V_{OS}	$V_{CM} = 2.5V$ (Note 1)		± 1.5	± 6.0	mV
Input Offset Voltage Tempco	TC_{VOS}			± 10		$\mu V/^\circ C$
Input Offset Voltage Matching				± 1		mV
Input Bias Current (Positive Input)	I_{B+}			± 1	± 10	μA
Input Bias Current (Negative Input)	I_{B-}			± 2	± 12	μA
Input Resistance (Positive Input)	R_{IN+}	$1.6V \leq V_{CM} \leq 3.4V$, $ V_{IN+} - V_{IN-} \leq 1V$	100	350		$k\Omega$
Input Resistance (Negative Input)	R_{IN-}			300		Ω
Input Capacitance (Positive Input)	C_{IN}			2.5		pF
Common-Mode Rejection Ratio	CMRR	$1.5V \leq V_{CM} \leq 3.5V$	48	65		dB
Open-Loop Transresistance	T_R	$1.3V \leq V_{OUT} \leq 3.7V$, $R_L = 1k\Omega$	1.0	6.5		$M\Omega$
		$1.45V \leq V_{OUT} \leq 3.55V$, $R_L = 150\Omega$	0.2	1.0		
Output Voltage Swing	V_{SW}	$R_L = 1k\Omega$	1.2 to 3.8	0.9 to 4.1		V
		$R_L = 150\Omega$	1.4 to 3.6	1.15 to 3.85		
Output Current	I_{OUT}	$R_L = 30\Omega$	± 16	± 28		mA
Output Short-Circuit Current	I_{SC}			± 50		mA
Output Resistance	R_{OUT}			0.2		Ω
Disabled Output Leakage Current	$I_{OUT(OFF)}$	$\overline{DISABLE}_- \leq V_{IL}$, $1.2V \leq V_{OUT} \leq 3.8V$ (Note 2)		0.8	± 5	μA
Disabled Output Capacitance	$C_{OUT(OFF)}$	$\overline{DISABLE}_- \leq V_{IL}$, $1.2V \leq V_{OUT} \leq 3.8V$		5		pF
$\overline{DISABLE}_-$ Low Threshold	V_{IL}	(Note 3)			$V_{CC} - 3$	V
$\overline{DISABLE}_-$ High Threshold	V_{IH}	(Note 3)	$V_{CC} - 1.8$			V
$\overline{DISABLE}_-$ Input Current	I_{IN}	$0 \leq \overline{DISABLE}_- \leq V_{CC}$		0.1	2	μA
Power-Supply Rejection Ratio (V_{CC})	PSRR+	$V_{CC} = 4.5V$ to $5.5V$	60	75		dB
Quiescent Supply Current (per Amplifier)	I_S	$R_L = open$		1.5	1.85	mA
Disabled Supply Current (per Amplifier)	$I_{S(OFF)}$	$\overline{DISABLE}_- \leq V_{IL}$, $R_L = open$		0.45	0.65	mA

Single/Triple, Low-Glitch, 250MHz, Current-Feedback Amplifiers with High-Speed Disable

AC ELECTRICAL CHARACTERISTICS—Dual Supplies (MAX4188)

($V_{CC} = +5V$, $V_{EE} = -5V$, $V_{IN} = 0$, $\overline{DISABLE} \geq 3V$, $A_v = +2V/V$, $R_f = R_G = 910\Omega$ for $R_L = 1k\Omega$ or $R_f = R_G = 560\Omega$ for $R_L = 150\Omega$; $T_A = +25^\circ C$, unless otherwise noted.)

PARAMETER	SYMBOL	CONDITIONS		MIN	TYP	MAX	UNITS
Small-Signal -3dB Bandwidth	BW _{-3dB}	$R_L = 1k\Omega$		200			MHz
		$R_L = 150\Omega$		160			
Peaking		$R_L = 1k\Omega$		0.25			dB
		$R_L = 150\Omega$		0.1			
Bandwidth for 0.1dB Flatness	BW _{0.1dB}	$R_L = 1k\Omega$		60			MHz
		$R_L = 150\Omega$		80			
Large-Signal -3dB Bandwidth	BW _{LS}	$V_{OUT} = 2V_{p-p}$	$R_L = 1k\Omega$	100			MHz
			$R_L = 150\Omega$	100			
Slew Rate	SR	$V_{OUT} = 4V$ step, $R_L = 150\Omega$	Positive slew	350			V/ μs
			Negative slew	280			
Settling Time to 0.1%	t_s	$V_{OUT} = 4V$ step		22			ns
Rise/Fall Time		$V_{OUT} = 4V$ step	Rise time	10			ns
			Fall time	12			
Spurious-Free Dynamic Range	SFDR	$f_c = 5MHz$, $V_{OUT} = 2V_{p-p}$	$R_L = 1k\Omega$	70			dB
			$R_L = 150\Omega$	56			
Second Harmonic Distortion		$f_c = 5MHz$, $V_{OUT} = 2V_{p-p}$	$R_L = 1k\Omega$	-70			dBc
			$R_L = 150\Omega$	-66			
Third Harmonic Distortion		$f_c = 5MHz$, $V_{OUT} = 2V_{p-p}$	$R_L = 1k\Omega$	-73			dBc
			$R_L = 150\Omega$	-56			
Differential Phase Error	DP	NTSC	$R_L = 1k\Omega$	0.05			degrees
			$R_L = 150\Omega$	0.32			
Differential Gain Error	DG	NTSC	$R_L = 1k\Omega$	0.03			%
			$R_L = 150\Omega$	0.04			
Input Noise Voltage Density	e_n	$f = 10kHz$		2			nV/ \sqrt{Hz}
Input Noise Current Density	i_n	$f = 10kHz$	Positive input	4			pA/ \sqrt{Hz}
			Negative input	5			
Output Impedance	Z_{OUT}	$f = 10MHz$		4			Ω
Crosstalk		$f = 10MHz$, input referred		-55			dB
All Hostile Off Isolation		$f = 10MHz$, input referred		-65			dB
Gain Matching to 0.1dB				100			MHz
Amplifier Enable Time	t_{ON}	Delay from $\overline{DISABLE}$ to 90% of V_{OUT} , $V_{IN} = 0.5V$		120			ns
Amplifier Disable Time	t_{OFF}	Delay from $\overline{DISABLE}$ to 10% of V_{OUT} , $V_{IN} = 0.5V$		35			ns
Disable/Enable Switching Transient		Positive transient		30			mV
		Negative transient		15			

Single/Triple, Low-Glitch, 250MHz, Current-Feedback Amplifiers with High-Speed Disable

AC ELECTRICAL CHARACTERISTICS—Dual Supplies (MAX4189)

($V_{CC} = +5V$, $V_{EE} = -5V$, $V_{IN} = 0$, $\overline{DISABLE} \geq 3V$, $A_V = +1V/V$, $R_F = 1600\Omega$ for $R_L = 1k\Omega$ and $R_F = 1100\Omega$ for $R_L = 150\Omega$; $T_A = +25^\circ C$, unless otherwise noted.)

PARAMETER	SYMBOL	CONDITIONS		MIN	TYP	MAX	UNITS
Small-Signal -3dB Bandwidth	BW-3dB	$R_L = 1k\Omega$		250			MHz
		$R_L = 150\Omega$		210			
Peaking		$R_L = 1k\Omega$		1.4			dB
		$R_L = 150\Omega$		0.15			
Bandwidth for 0.1dB Flatness	BW _{0.1dB}	$R_L = 1k\Omega$		7			MHz
		$R_L = 150\Omega$		30			
Large-Signal -3dB Bandwidth	BW _{LS}	$V_{OUT} = 2V_{p-p}$	$R_L = 1k\Omega$	60			MHz
			$R_L = 150\Omega$	55			
Slew Rate	SR	$V_{OUT} = 4V$ step, $R_L = 150\Omega$	Positive slew	175			V/ μs
			Negative slew	150			
Settling Time to 0.1%	t_s	$V_{OUT} = 4V$ step		28			ns
Rise/Fall Time		$V_{OUT} = 4V$ step	Rise time	20			ns
			Fall time	22			
Spurious-Free Dynamic Range	SFDR	$f_c = 5MHz$, $V_{OUT} = 2V_{p-p}$	$R_L = 1k\Omega$	65			dB
			$R_L = 150\Omega$	51			
Second Harmonic Distortion		$f_c = 5MHz$, $V_{OUT} = 2V_{p-p}$	$R_L = 1k\Omega$	-65			dBc
			$R_L = 150\Omega$	-63			
Third Harmonic Distortion		$f_c = 5MHz$, $V_{OUT} = 2V_{p-p}$	$R_L = 1k\Omega$	-70			dBc
			$R_L = 150\Omega$	-51			
Differential Phase Error	DP	NTSC	$R_L = 1k\Omega$	0.02			degrees
			$R_L = 150\Omega$	0.66			
Differential Gain Error	DG	NTSC	$R_L = 1k\Omega$	0.07			%
			$R_L = 150\Omega$	0.18			
Input Noise Voltage Density	e_n	$f = 10kHz$		2			nV/ \sqrt{Hz}
Input Noise Current Density	i_n	$f = 10kHz$	Positive input	4			pA/ \sqrt{Hz}
			Negative input	5			
Output Impedance	Z_{OUT}	$f = 10MHz$		4			Ω
Crosstalk		$f = 10MHz$, input referred		-57			dB
All Hostile Off Isolation		$f = 10MHz$, input referred		-55			dB
Gain Matching to 0.1dB				24			MHz
Amplifier Enable Time	t_{ON}	Delay from $\overline{DISABLE}$ to 90% of V_{OUT} , $V_{IN} = 0.5V$		120			ns
Amplifier Disable Time	t_{OFF}	Delay from $\overline{DISABLE}$ to 10% of V_{OUT} , $V_{IN} = 0.5V$		40			ns
Disable/Enable Switching Transient		Positive transient		70			mV
		Negative transient		110			

MAX4188/MAX4189/MAX4190

Single/Triple, Low-Glitch, 250MHz, Current-Feedback Amplifiers with High-Speed Disable

MAX4188/MAX4189/MAX4190

AC & DYNAMIC PERFORMANCE—Dual Supplies (MAX4190)

($V_{CC} = +5V$, $V_{EE} = -5V$, $V_{IN} = 0$, $A_V = +2V/V$; $R_F = R_G = 1300\Omega$ for $R_L = 1k\Omega$ and $R_F = R_G = 680\Omega$ for $R_L = 150\Omega$, $T_A = +25^\circ C$, unless otherwise noted.)

PARAMETER	SYMBOL	CONDITIONS		MIN	TYP	MAX	UNITS	
Small-Signal -3dB Bandwidth	BW _{SS}	R _L = 1k Ω				185	MHz	
		R _L = 150 Ω				150		
Peaking		R _L = 1k Ω				0.1	dB	
		R _L = 150 Ω				0.1		
Bandwidth for 0.1dB Flatness	BW _{LS}	R _L = 1k Ω				85	MHz	
		R _L = 150k Ω				75		
Large-Signal -3dB Bandwidth	BW _{LS}	V _O = 2Vp-p	R _L = 1k Ω			95	MHz	
			R _L = 150 Ω			95		
Slew Rate	SR	V _O = 4V step, R _L = 150 Ω	Positive slew				340	V/ μ s
			Negative slew				270	
Settling Time to 0.1%	t _S	V _O = 2V step				22	ns	
Rise/Fall Time	t _R	V _O = 4V step, R _L = 150 Ω	Rise time				10	ns
	t _F		Fall time				12	
Spurious-Free Dynamic Range		f _C = 5MHz, V _O = 2Vp-p	R _L = 1k Ω				61	dB
			R _L = 150 Ω				55	
Second Harmonic Distortion		f _C = 5MHz, V _O = 2Vp-p	R _L = 1k Ω				-65	dBc
			R _L = 150 Ω				-55	
Third Harmonic Distortion		f _C = 5MHz, V _O = 2Vp-p	R _L = 1k Ω				-73	dBc
			R _L = 150 Ω				-61	
Differential Gain Error	DG	NTSC	R _L = 1k Ω				0.03	degrees
			R _L = 150 Ω				0.07	
Differential Phase Error	DP	NTSC	R _L = 1k Ω				0.06	degrees
			R _L = 150 Ω				0.45	
Input Noise Current Density		f = 10kHz	Positive input				4	pA/ \sqrt{Hz}
			Negative input				5	
Input Noise Voltage Density	e _n	f = 10kHz				2	nV/ \sqrt{Hz}	
Output Impedance	Z _{OUT}	f = 10MHz				4	Ω	
All Hostile Off Isolation		f = 10MHz, input referred				-60	dB	
Turn-On Time from $\overline{DISABLE}$	t _{ON}					120	ns	
Turn-Off Time from $\overline{DISABLE}$	t _{OFF}					35	ns	
Disable/Enable Switching Transient	BW _{LS}	Positive transient				30	mV	
		Negative transient				15		

Single/Triple, Low-Glitch, 250MHz, Current-Feedback Amplifiers with High-Speed Disable

AC ELECTRICAL CHARACTERISTICS—Single Supply (MAX4188)

($V_{CC} = +5V$, $V_{EE} = 0$, $V_{IN} = 2.5V$, $\overline{DISABLE} \geq 3V$, R_L to $V_{CC} / 2$, $A_v = +2V/V$, $R_F = R_G = 1.1k\Omega$ for $R_L = 1k\Omega$ to $V_{CC} / 2$ and $R_F = R_G = 620\Omega$ for $R_L = 150\Omega$; $T_A = +25^\circ C$, unless otherwise noted.)

PARAMETER	SYMBOL	CONDITIONS		MIN	TYP	MAX	UNITS
Small-Signal -3dB Bandwidth	BW _{-3dB}	R _L = 1k Ω		185			MHz
		R _L = 150 Ω		145			
Peaking		R _L = 1k Ω		0.1			dB
		R _L = 150 Ω		0.1			
Bandwidth for 0.1dB Flatness	BW _{0.1dB}	R _L = 1k Ω		110			MHz
		R _L = 150 Ω		65			
Large-Signal -3dB Bandwidth	BW _{LS}	V _{OUT} = 2Vp-p	R _L = 1k Ω	80			MHz
			R _L = 150 Ω	80			
Slew Rate	SR	V _{OUT} = 2V step, R _L = 150 Ω	Positive slew	300			V/ μ s
			Negative slew	230			V/ μ s
Settling Time to 0.1%	t _s	V _{OUT} = 2V step		20			ns
Rise/Fall Time		V _{OUT} = 2V step	Rise time	8			ns
			Fall time	9			
Spurious-Free Dynamic Range	SFDR	f _C = 5MHz, V _{OUT} = 2Vp-p	R _L = 1k Ω	66			dB
			R _L = 150 Ω	56			
Second Harmonic Distortion		f _C = 5MHz, V _{OUT} = 2Vp-p	R _L = 1k Ω	-76			dBc
			R _L = 150 Ω	-59			
Third Harmonic Distortion		f _C = 5MHz, V _{OUT} = 2Vp-p	R _L = 1k Ω	-66			dBc
			R _L = 150 Ω	-56			
Differential Phase Error	DP	NTSC	R _L = 1k Ω	0.06			degrees
			R _L = 150 Ω	0.34			
Differential Gain Error	DG	NTSC	R _L = 1k Ω	0.02			%
			R _L = 150 Ω	0.05			
Input Noise Voltage Density	e _n	f = 10kHz		2			nV/ \sqrt{Hz}
Input Noise Current Density	i _n	f = 10kHz	Positive input	4			pA/ \sqrt{Hz}
			Negative input	5			
Output Impedance	Z _{OUT}	f = 10MHz		4			Ω
Crosstalk		f = 10MHz, input referred		-55			dB
All Hostile Off Isolation		f = 10MHz, input referred		-65			dB
Gain Matching to 0.1dB				40			MHz
Amplifier Enable Time	t _{ON}	Delay from $\overline{DISABLE}$ to 90% of V _{OUT} , V _{IN} = 3V		120			ns
Amplifier Disable Time	t _{OFF}	Delay from $\overline{DISABLE}$ to 10% of V _{OUT} , V _{IN} = 3V		35			ns
Disable/Enable Switching Transient		Positive transient		30			mV
		Negative transient		15			

MAX4188/MAX4189/MAX4190

Single/Triple, Low-Glitch, 250MHz, Current-Feedback Amplifiers with High-Speed Disable

AC ELECTRICAL CHARACTERISTICS—Single Supply (MAX4189)

($V_{CC} = +5V$, $V_{EE} = 0$, $V_{IN} = 2.5V$, $\overline{DISABLE} \geq 3V$, R_L to $V_{CC} / 2$, $A_V = +1V/V$, $R_F = 1500\Omega$ for $R_L = 1k\Omega$ and $R_F = 1600\Omega$ for $R_L = 150\Omega$; $T_A = +25^\circ C$, unless otherwise noted.)

PARAMETER	SYMBOL	CONDITIONS		MIN	TYP	MAX	UNITS
Small-Signal -3dB Bandwidth	BW _{-3dB}	$R_L = 1k\Omega$		230			MHz
		$R_L = 150\Omega$		190			
Peaking		$R_L = 1k\Omega$		1.4			dB
		$R_L = 150\Omega$		0.15			
Bandwidth for 0.1dB Flatness	BW _{0.1dB}	$R_L = 1k\Omega$		7			MHz
		$R_L = 150\Omega$		40			
Large-Signal -3dB Bandwidth	BW _{LS}	$V_{OUT} = 2V_{p-p}$	$R_L = 1k\Omega$	50			MHz
			$R_L = 150\Omega$	45			
Slew Rate	SR	$V_{OUT} = 2V$ step, $R_L = 150\Omega$	Positive slew	160			V/ μs
			Negative slew	135			
Settling Time to 0.1%	t_s	$V_{OUT} = 2V$ step		25			ns
Rise/Fall Time		$V_{OUT} = 2V$ step	Rise time	12			ns
			Fall time	15			
Spurious-Free Dynamic Range	SFDR	$f_C = 5MHz$, $V_{OUT} = 2V_{p-p}$	$R_L = 1k\Omega$	57			dB
			$R_L = 150\Omega$	47			
Second Harmonic Distortion		$f_C = 5MHz$, $V_{OUT} = 2V_{p-p}$	$R_L = 1k\Omega$	-58			dBc
			$R_L = 150\Omega$	-54			
Third Harmonic Distortion		$f_C = 5MHz$, $V_{OUT} = 2V_{p-p}$	$R_L = 1k\Omega$	-57			dBc
			$R_L = 150\Omega$	-47			
Differential Phase Error	DP	NTSC	$R_L = 1k\Omega$	0.04			degrees
			$R_L = 150\Omega$	0.66			
Differential Gain Error	DG	NTSC	$R_L = 1k\Omega$	0.06			%
			$R_L = 150\Omega$	0.17			
Input Noise Voltage Density	e_n	$f = 10kHz$		2			nV/\sqrt{Hz}
Input Noise Current Density	i_n	$f = 10kHz$	Positive input	4			pA/\sqrt{Hz}
			Negative input	5			
Output Impedance	Z_{OUT}	$f = 10MHz$		4			Ω
Crosstalk		$f = 10MHz$, input referred		-57			dB
All Hostile Off Isolation		$f = 10MHz$, input referred		-55			dB
Gain Matching to 0.1dB				25			MHz
Amplifier Enable Time	t_{ON}	Delay from $\overline{DISABLE}$ to 90% of V_{OUT} , $V_{IN} = 3V$		120			ns
Amplifier Disable Time	t_{OFF}	Delay from $\overline{DISABLE}$ to 10% of V_{OUT} , $V_{IN} = 3V$		40			ns
Disable/Enable Switching Transient		Positive transient		70			mV
		Negative transient		110			

Note 1: Input Offset Voltage does not include the effect of I_{BIAS} flowing through R_F/R_G .

Note 2: Does not include current through external feedback network.

Note 3: Over operating supply-voltage range.

Single/Triple, Low-Glitch, 250MHz, Current-Feedback Amplifiers with High-Speed Disable

MAX4188/MAX4189/MAX4190

AC & DYNAMIC PERFORMANCE—Single Supply (MAX4190)

($V_{CC} = +5V$, $V_{EE} = 0$, $V_{IN} = 0$, $A_v = +2V/V$; $R_F = R_G = 1500\Omega$ for $R_L = 1k\Omega$ and $R_F = R_G = 750\Omega$ for $R_L = 150\Omega$, $T_A = +25^\circ C$, unless otherwise noted)

PARAMETER	SYMBOL	CONDITIONS		MIN	TYP	MAX	UNITS
Small-Signal -3dB Bandwidth	BW-3dB	$R_L = 1k\Omega$		165			MHz
		$R_L = 150\Omega$		135			
Peaking		$R_L = 1k\Omega$		0.1			dB
		$R_L = 150\Omega$		0.1			
Bandwidth for 0.1dB Flatness	BW _{0.1dB}	$R_L = 1k\Omega$		70			MHz
		$R_L = 150\Omega$		65			
Large-Signal -3dB Bandwidth	BW _{LS}	$V_O = 2V_{p-p}$	$R_L = 1k\Omega$	75		MHz	
			$R_L = 150\Omega$	75			
Slew Rate	SR	$V_O = 2V$ step, $R_L = 150\Omega$	Positive slew	290		V/ μs	
			Negative slew	220			
Settling Time to 0.1%	t_s	$V_O = 2V$ step		20		ns	
Rise/Fall Time	t_R t_F	$V_O = 2V$ step, $R_L = 150\Omega$	Rise time	8		ns	
			Fall time	9			
Spurious-Free Dynamic Range		$f_C = 5MHz$, $V_O = 2V_{p-p}$	$R_L = 1k\Omega$	59		dB	
			$R_L = 150\Omega$	55			
Second Harmonic Distortion		$f_C = 5MHz$, $V_O = 2V_{p-p}$	$R_L = 1k\Omega$	-59		dBc	
			$R_L = 150\Omega$	-55			
Third Harmonic Distortion		$f_C = 5MHz$, $V_O = 2V_{p-p}$	$R_L = 1k\Omega$	-68		dBc	
			$R_L = 150\Omega$	-60			
Differential Gain Error	DG	NTSC	$R_L = 1k\Omega$	0.02		%	
			$R_L = 150\Omega$	0.08			
Differential Phase Error	DP	NTSC	$R_L = 1k\Omega$	0.07		degrees	
			$R_L = 150\Omega$	0.43			
Input Noise Voltage Density		$f = 10kHz$		2		nV/ \sqrt{Hz}	
Input Noise Current Density	i_n	$f = 10kHz$	Positive input	4		pA/ \sqrt{Hz}	
			Negative input	5			
Output Impedance	Z_{OUT}	$f = 10MHz$		4		Ω	
All Hostile Off Isolation		$f = 10MHz$, input referred, $R_L = 150\Omega$		-60		dB	
Turn-On Time from $\overline{DISABLE}$	t_{ON}			120		ns	
Turn-Off Time from $\overline{DISABLE}$	t_{OFF}			35		ns	
Disable/Enable Switching Transient	BW _{LS}	Positive transient		30		mV	
		Negative transient		15			

Single/Triple, Low-Glitch, 250MHz, Current-Feedback Amplifiers with High-Speed Disable

Typical Operating Characteristics

($V_{CC} = +5V$, $V_{EE} = -5V$, $T_A = +25^{\circ}C$, unless otherwise noted.)

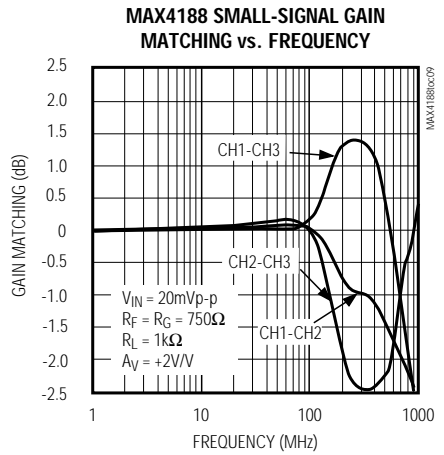
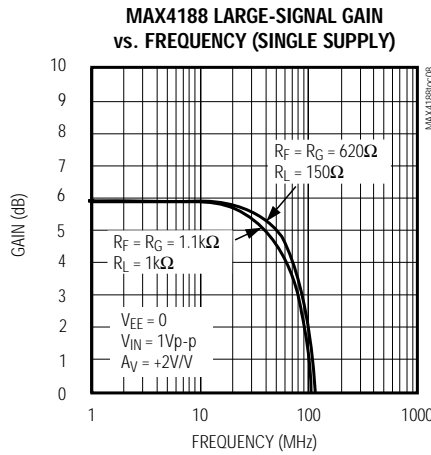
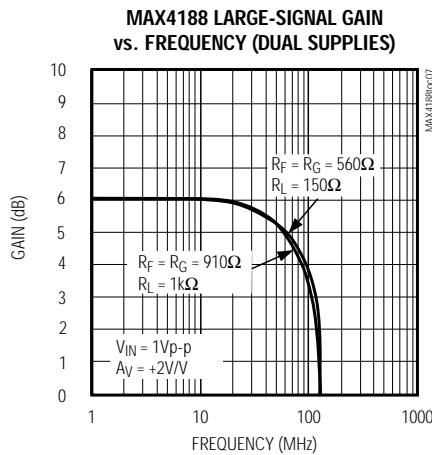
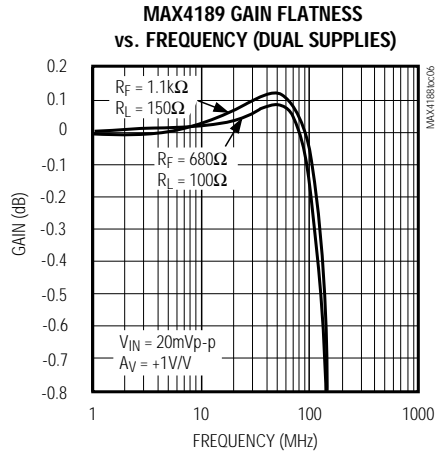
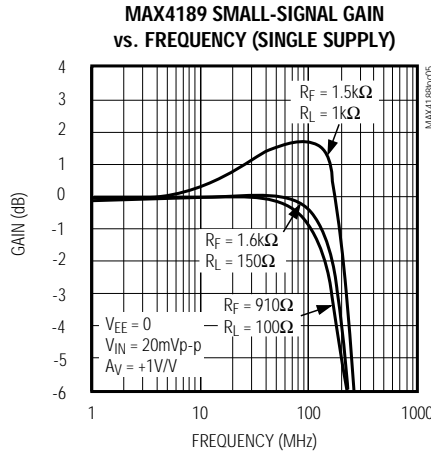
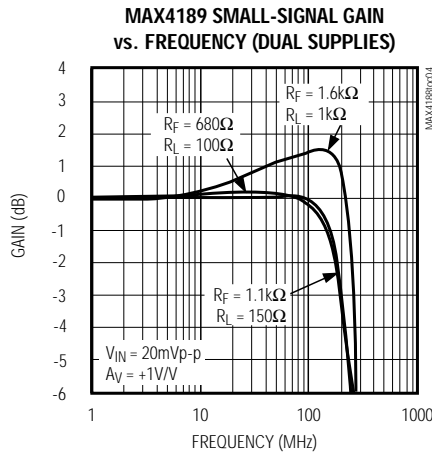
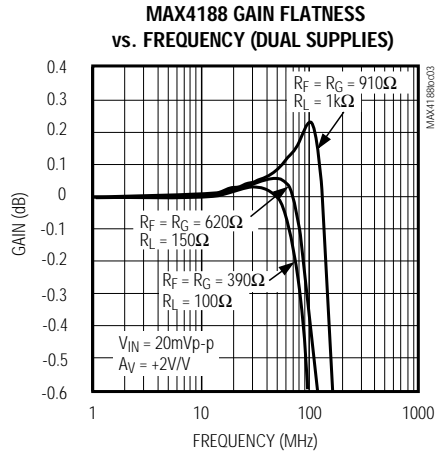
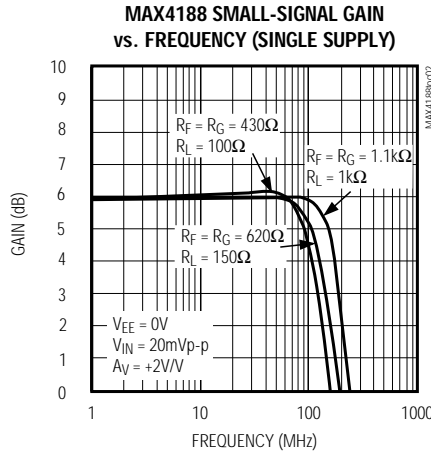
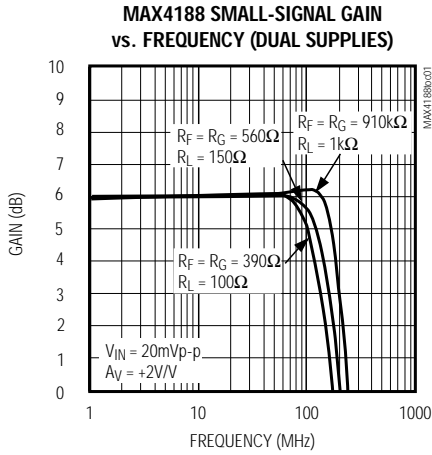

Single/Triple, Low-Glitch, 250MHz, Current-Feedback Amplifiers with High-Speed Disable

Typical Operating Characteristics (continued)

($V_{CC} = +5V$, $V_{EE} = -5V$, $T_A = +25^\circ C$, unless otherwise noted.)

MAX4188/MAX4189/MAX4190

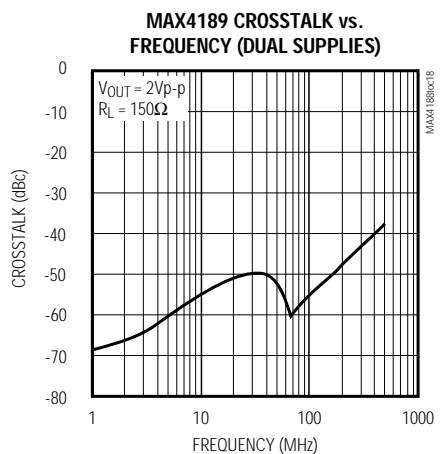
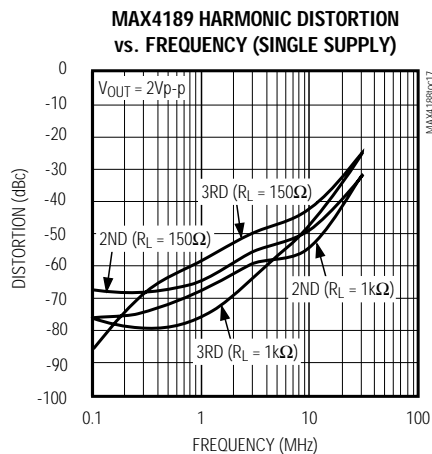
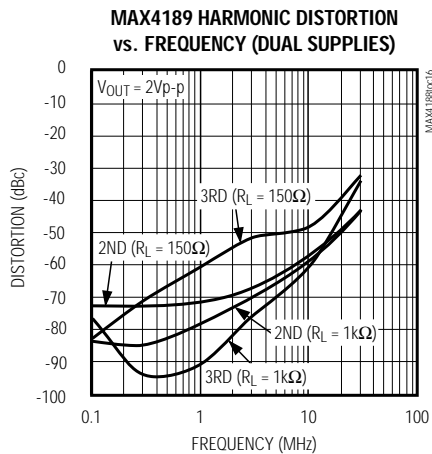
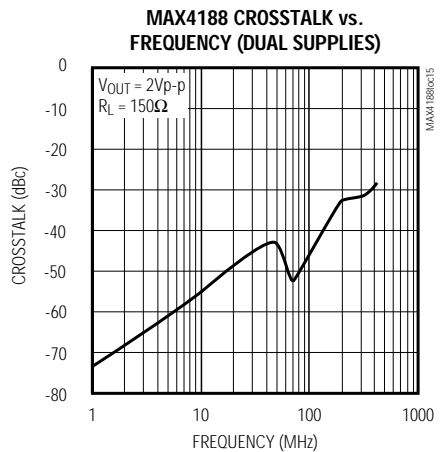
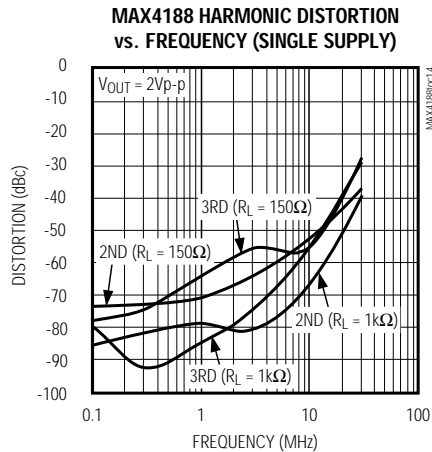
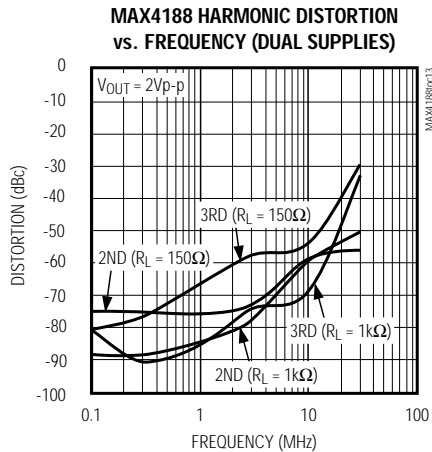
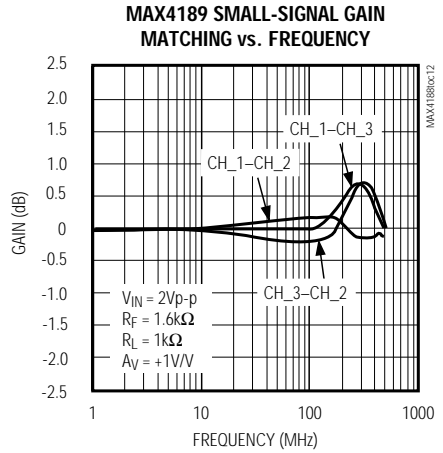
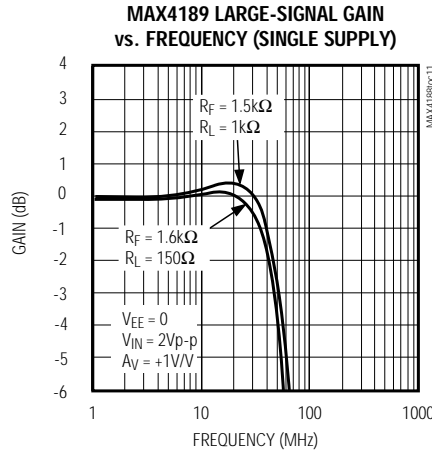
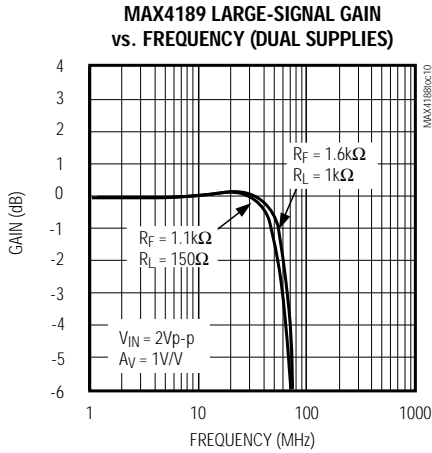

Single/Triple, Low-Glitch, 250MHz, Current-Feedback Amplifiers with High-Speed Disable

Typical Operating Characteristics (continued)

($V_{CC} = +5V$, $V_{EE} = -5V$, $T_A = +25^\circ C$, unless otherwise noted.)

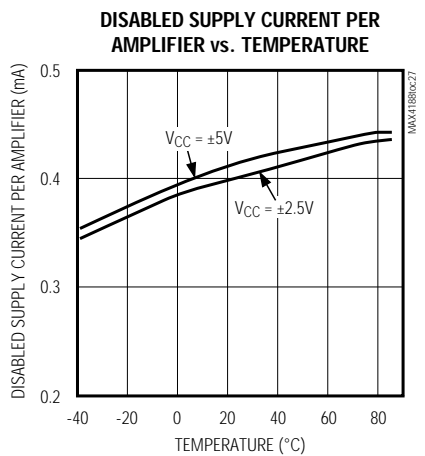
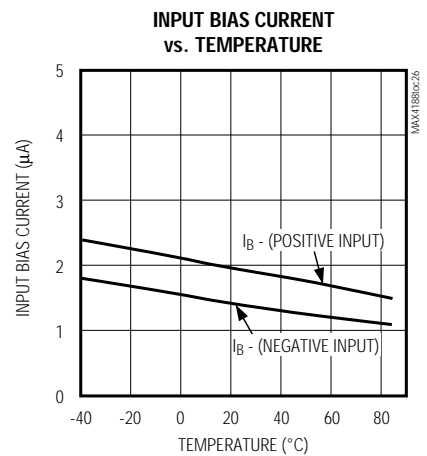
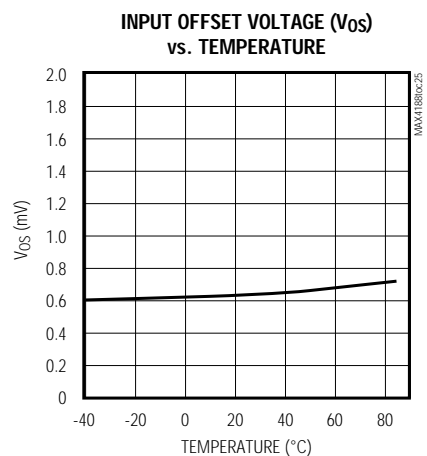
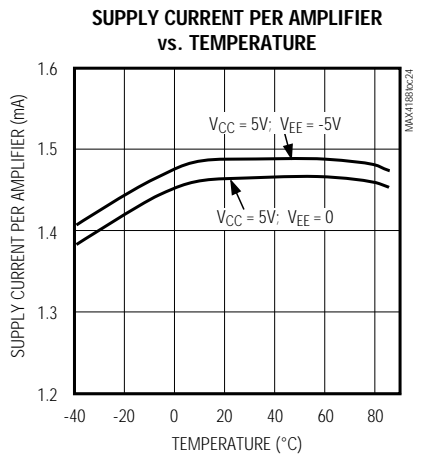
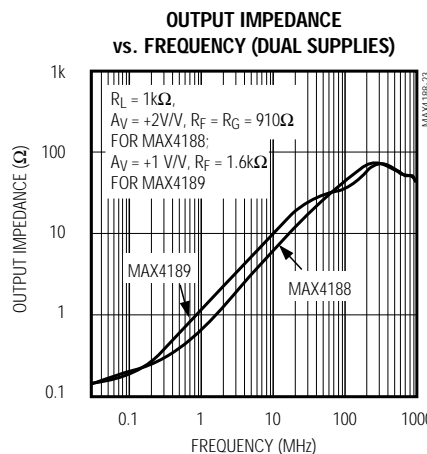
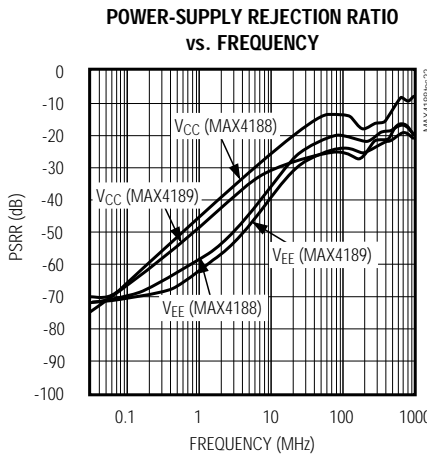
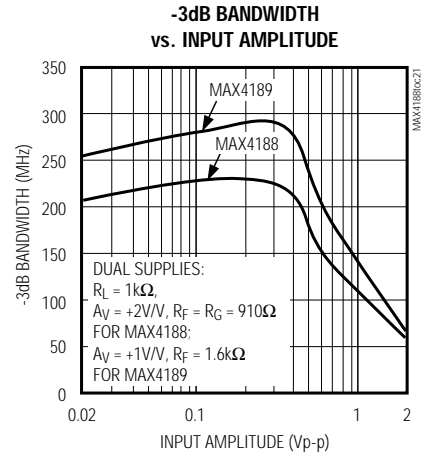
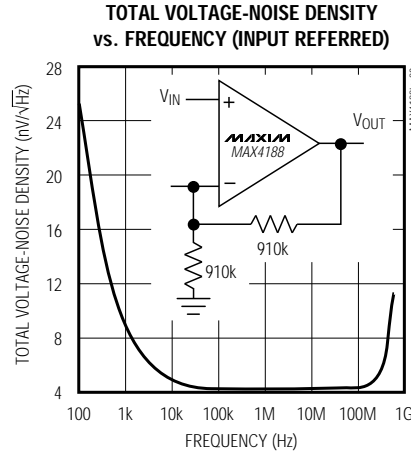
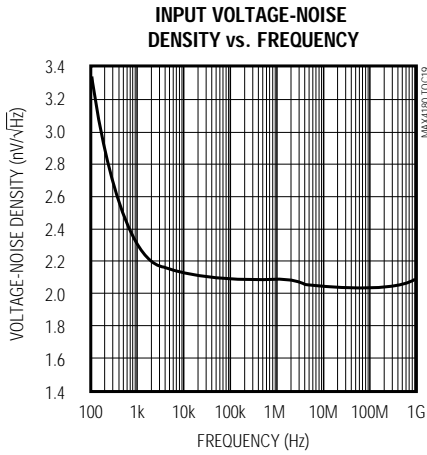

Single/Triple, Low-Glitch, 250MHz, Current-Feedback Amplifiers with High-Speed Disable

Typical Operating Characteristics (continued)

($V_{CC} = +5V$, $V_{EE} = -5V$, $T_A = +25^\circ C$, unless otherwise noted.)

MAX4188/MAX4189/MAX4190

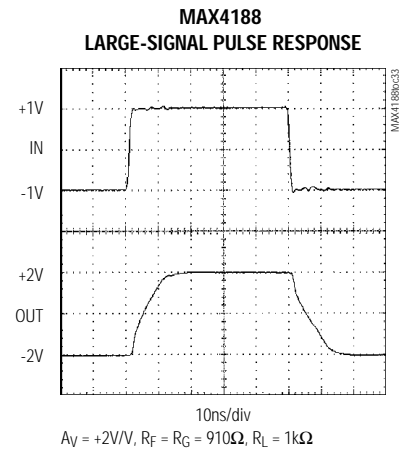
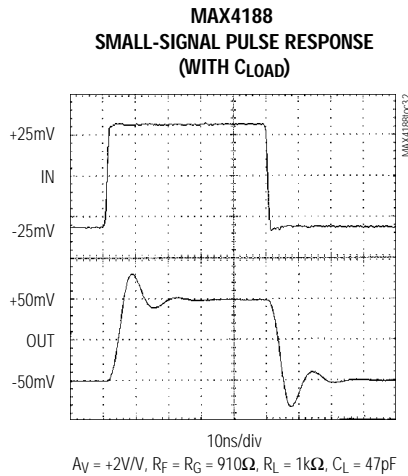
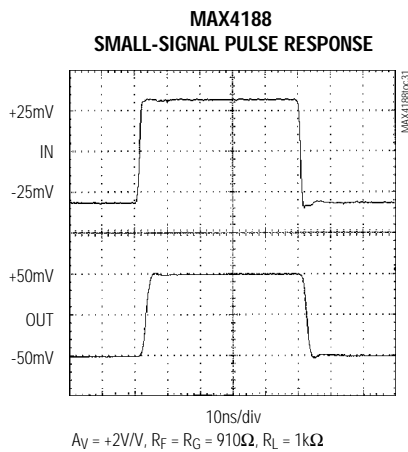
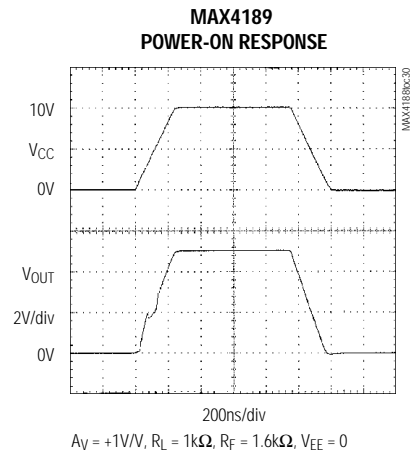
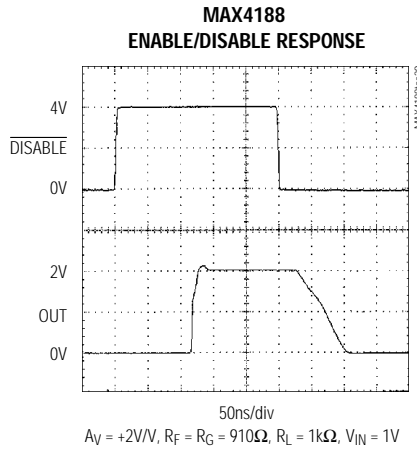
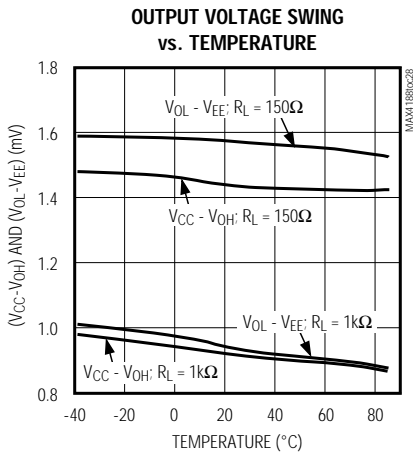

Single/Triple, Low-Glitch, 250MHz, Current-Feedback Amplifiers with High-Speed Disable

Typical Operating Characteristics (continued)

($V_{CC} = +5V$, $V_{EE} = -5V$, $T_A = +25^\circ C$, unless otherwise noted.)

MAX4189
SMALL-SIGNAL PULSE RESPONSE

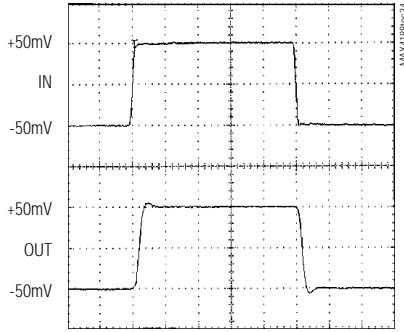

10ns/div
 $A_V = +1V/V$, $R_F = 1.1k\Omega$, $R_L = 150\Omega$

MAX4189
SMALL-SIGNAL PULSE RESPONSE
(WITH C_{LOAD})

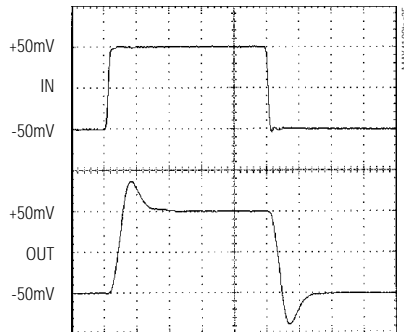

10ns/div
 $A_V = +1V/V$, $R_F = 1.6k\Omega$, $R_L = 1k\Omega$, $C_L = 47pF$

MAX4189
LARGE-SIGNAL PULSE RESPONSE

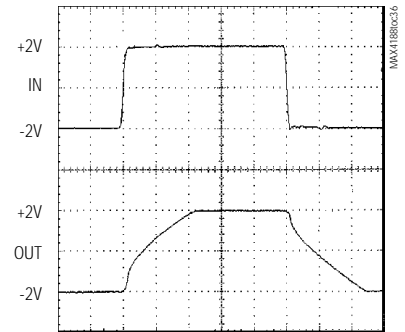

10ns/div
 $A_V = +1V/V$, $R_F = 1.1k\Omega$, $R_L = 150\Omega$

MAX4188
SWITCHING TRANSIENT

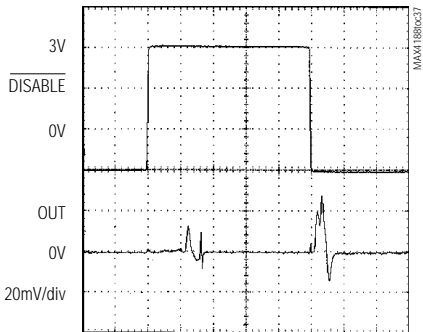

100ns/div
 $A_V = +2V/V$, $R_F = 910\Omega$, $R_L = 1k\Omega$, $V_{IN} = 0$

MAX4189
SWITCHING TRANSIENT

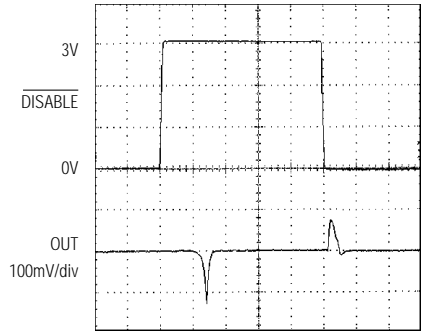

100ns/div
 $A_V = +1V/V$, $R_F = 1.6k\Omega$, $R_L = 1k\Omega$, $V_{IN} = 0$

OFF-CHANNEL FEEDTHROUGH
vs. FREQUENCY (DUAL SUPPLIES)

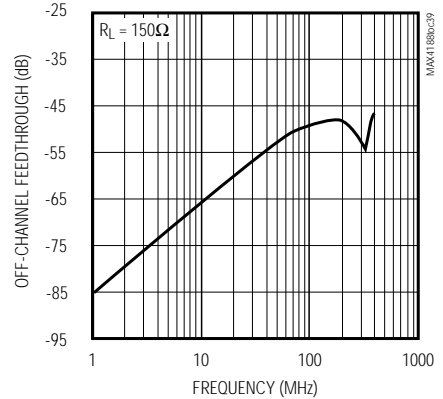

Single/Triple, Low-Glitch, 250MHz, Current-Feedback Amplifiers with High-Speed Disable

Pin Descriptions

MAX4188/MAX4189/MAX4190

PIN			NAME	FUNCTION
MAX4188/MAX4189		MAX4190		
SO	QSOP	SO/ μ MAX		
1	1	—	$\overline{\text{DISABLE1}}$	Disable Control Input for Amplifier 1. Amplifier 1 is enabled when $\overline{\text{DISABLE1}} \geq (V_{CC} - 2V)$ and disabled when $\overline{\text{DISABLE1}} \leq (V_{CC} - 3V)$.
2	2	—	$\overline{\text{DISABLE2}}$	Disable Control Input for Amplifier 2. Amplifier 2 is enabled when $\overline{\text{DISABLE2}} \geq (V_{CC} - 2V)$ and disabled when $\overline{\text{DISABLE2}} \leq (V_{CC} - 3V)$.
3	3	—	$\overline{\text{DISABLE3}}$	Disable Control Input for Amplifier 3. Amplifier 3 is enabled when $\overline{\text{DISABLE3}} \geq (V_{CC} - 2V)$ and disabled when $\overline{\text{DISABLE3}} \leq (V_{CC} - 3V)$.
4	4	7	V _{CC}	Positive Power Supply. Connect V _{CC} to +5V.
5	5	—	IN1+	Amplifier 1 Noninverting Input
6	6	—	IN1-	Amplifier 1 Inverting Input
7	7	—	OUT1	Amplifier 1 Output
—	8, 9	1, 5	N.C.	No Connect. Not internally connected.
8	10	—	OUT3	Amplifier 3 Output
9	11	—	IN3-	Amplifier 3 Inverting Input
10	12	—	IN3+	Amplifier 3 Noninverting Input
11	13	4	V _{EE}	Negative Power Supply. Connect V _{EE} to -5V or to ground for single-supply operation.
12	14	—	IN2+	Amplifier 2 Noninverting Input
13	15	—	IN2-	Amplifier 2 Inverting Input
14	16	—	OUT2	Amplifier 2 Output
—	—	2	IN-	Amplifier Inverting Input
—	—	3	IN+	Amplifier Noninverting Input
—	—	6	OUT	Amplifier Output
—	—	8	$\overline{\text{DISABLE}}$	Disable Control Input. Amplifier is enabled when $\overline{\text{DISABLE}} \geq (V_{CC} - 2V)$ and disabled when $\overline{\text{DISABLE}} \leq (V_{CC} - 3V)$.

Detailed Description

The MAX4188/MAX4189/MAX4190 are very low-power, current-feedback amplifiers featuring bandwidths up to 250MHz, 0.1dB gain flatness to 80MHz, and low differential gain (0.03%) and phase (0.05°) errors. These amplifiers achieve very high bandwidth-to-power ratios while maintaining low distortion, wide signal swing, and excellent load-driving capabilities. They are optimized for $\pm 5V$ supplies but are also fully specified for single +5V operation. Consuming only 1.5mA per amplifier, these devices have $\pm 55mA$ output current drive capability and achieve low distortion even while driving 150 Ω loads.

Wide bandwidth, low power, low differential phase/gain error, and excellent gain flatness make the MAX4188 family ideal for use in portable video equipment such as video cameras, video switchers, and other battery-powered equipment. Their two-stage design provides higher gain and lower distortion than conventional single-stage, current-feedback amplifiers. This feature, combined with a fast settling time, makes these devices suitable for buffering high-speed analog-to-digital converters.

The MAX4188/MAX4189/MAX4190 have a high-speed, low-power disable mode that is activated by driving the amplifiers' $\overline{\text{DISABLE}}$ input low. In the disable mode, the

Single/Triple, Low-Glitch, 250MHz, Current-Feedback Amplifiers with High-Speed Disable

amplifiers achieve very high isolation from input to output (65dB at 10MHz), and the outputs are placed into a high-impedance state. These amplifiers achieve low switching-transient glitches (<45mVp-p) when switching between enable and disable modes. Fast enable/disable times (120ns/35ns), along with high off-isolation and low switching transients, allow these devices to be used as high-performance, high-speed multiplexers. This is achieved by connecting the outputs of multiple amplifiers together and controlling the $\overline{\text{DISABLE}}$ inputs to enable one amplifier and disable all others. The disabled amplifiers present a very light load (1 μA leakage current and 3.5pF capacitance) to the active amplifier's output. The feedback network impedance of all the disabled amplifiers must still be considered when calculating the total load on the active amplifier output. Figure 1 shows an application circuit using the MAX4188 as a 3:1 video multiplexer.

The $\overline{\text{DISABLE}}$ logic threshold is typically $V_{CC} - 2.5\text{V}$, independent of V_{EE} . For a single +5V supply or dual $\pm 5\text{V}$ supplies, the disable inputs are CMOS-logic compatible. The amplifiers default to the enabled mode if the $\overline{\text{DISABLE}}$ pin is left unconnected. If the $\overline{\text{DISABLE}}$ pin is left floating, take proper care to ensure that no high-frequency signals are coupled to this pin, as this may cause false triggering.

Applications Information

Theory of Operation

The MAX4188/MAX4189/MAX4190 are current-feedback amplifiers, and their open-loop transfer function is expressed as a transimpedance, $\Delta V_{OUT}/\Delta I_{IN}$, or T_Z . The frequency behavior of the open-loop transimpedance is similar to the open-loop gain of a voltage-mode feedback amplifier. That is, it has a large DC value and decreases at approximately 6dB per octave.

Analyzing the follower with gain, as shown in Figure 2, yields the following transfer function:

$$V_{OUT} / V_{IN} = G \times [(T_Z(s) / T_Z(s) + G \times (R_{IN} + R_F)]$$

where $G = A_{VCL} = 1 + (R_F / R_G)$, and $R_{IN} = 1/g_m \cong 300\Omega$.

At low gains, $G \times R_{IN} < R_F$. Therefore, the closed-loop bandwidth is essentially independent of closed-loop gain. Similarly $T_Z > R_F$ at low frequencies, so that:

$$\frac{V_{OUT}}{V_{IN}} = G = 1 + (R_F / R_G)$$

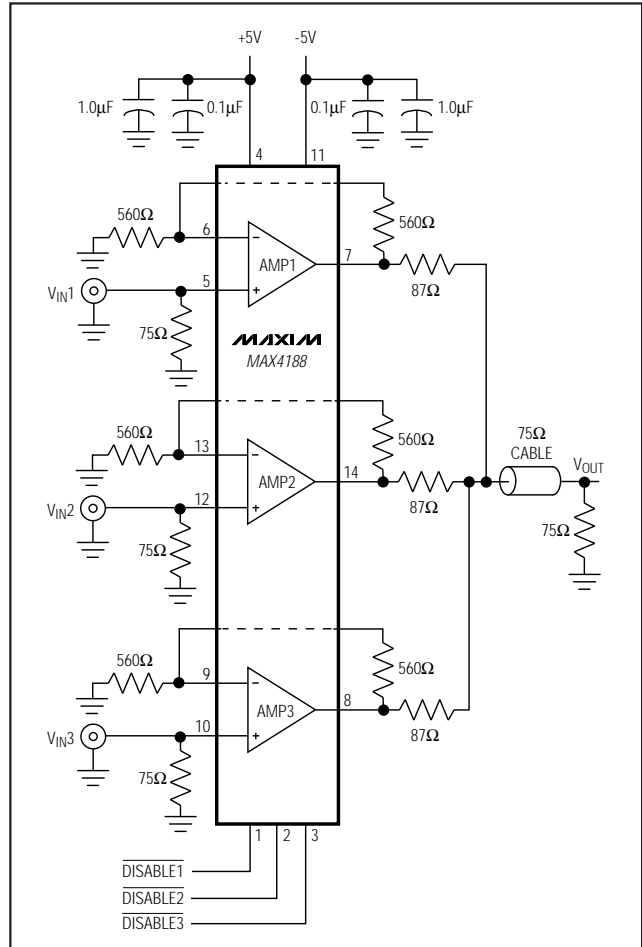

Figure 1. High-Speed 3:1 Video Multiplexer

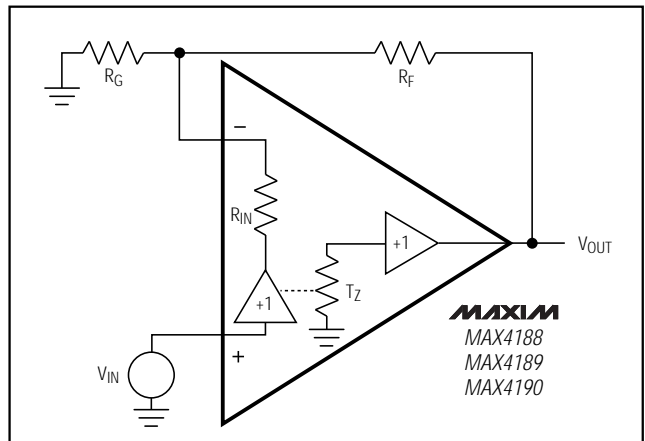

Figure 2. Current-Feedback Amplifier

Single/Triple, Low-Glitch, 250MHz, Current-Feedback Amplifiers with High-Speed Disable

MAX4188/MAX4189/MAX4190

Layout and Power-Supply Bypassing

As with all wideband amplifiers, a carefully laid out printed circuit board and adequate power-supply bypassing are essential to realizing the optimum AC performance of MAX4188/MAX4189/MAX4190. The PC board should have at least two layers. Signal and power should be on one layer. A large low-impedance ground plane, as free of voids as possible, should be the other layer. With multilayer boards, locate the ground plane on a layer that incorporates no signal or power traces.

Do not use wire-wrap boards or breadboards and sockets. Wire-wrap boards are too inductive. Breadboards and sockets are too capacitive. Surface-mount components have lower parasitic inductance and capacitance, and are therefore preferable to through-hole components. Keep lines as short as possible to minimize parasitic inductance, and avoid 90° turns. Round all corners. Terminate all unused amplifier inputs to ground with a 100Ω or 150Ω resistor.

The MAX4188/MAX4189/MAX4190 achieve a high degree of off-isolation (65dB at 10MHz) and low crosstalk (-55dB at 10MHz). The input and output signal traces must be kept from overlapping to achieve high off-isolation. Coupling between the signal traces of different channels will degrade crosstalk. The signal traces of each channel should be kept from overlapping with the signal traces of the other channels.

Adequate bypass capacitance at each supply is very important to optimize the high-frequency performance of these amplifiers. Inadequate bypassing will also degrade crosstalk rejection, especially with heavier loads. Use a 1μF capacitor in parallel with a 0.01μF to 0.1μF capacitor between each supply pin and ground to achieve optimum performance. The bypass capacitors should be located as close to the device as possible. A 10μF low-ESR tantalum capacitor may be required to produce the best settling time and lowest distortion when large transient currents must be delivered to a load.

Choosing Feedback and Gain Resistors

The optimum value of the external-feedback (R_F) and gain-setting (R_G) resistors used with the MAX4188/MAX4189/MAX4190 depends on the closed-loop gain and the application circuit's load. Table 1 lists the optimum resistor values for some specific gain configurations. One-percent resistor values are preferred to maintain consistency over a wide range of production lots. Figures 3a and 3b show the standard inverting and noninverting configurations. Note that the noninverting circuit gain (Figure 3b) is 1 plus the magnitude of the inverting closed-loop gain. Otherwise, the two circuits are identical.

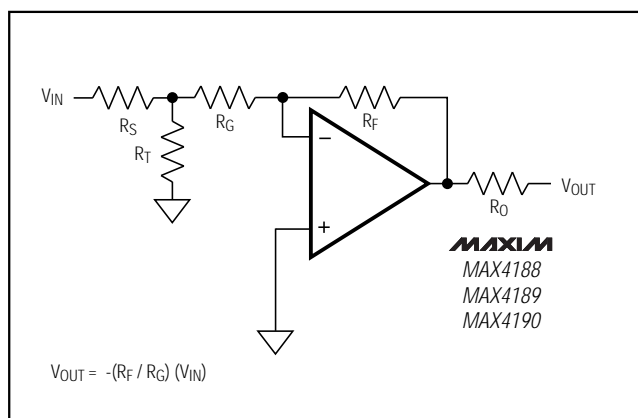

Figure 3a. Inverting Gain Configuration

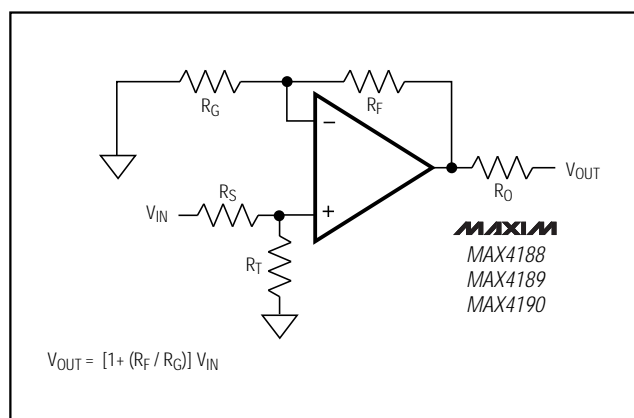

Figure 3b. Noninverting Gain Configuration

Single/Triple, Low-Glitch, 250MHz, Current-Feedback Amplifiers with High-Speed Disable

Table 1a. MAX4188 Recommended Component Values

COMPONENT/ BW	DUAL SUPPLIES					SINGLE SUPPLY				
	Av = +2V/V			Av = +5 (V/V)	Av = +10 (V/V)	Av = +2V/V			Av = +5 V/V	Av = +10 V/V
	R _L = 1kΩ	R _L = 150Ω	R _L = 100Ω	R _L = 1kΩ	R _L = 1kΩ	R _L = 1kΩ	R _L = 150Ω	R _L = 100Ω	R _L = 1kΩ	R _L = 1kΩ
R _F (Ω)	910	560	390	470	470	1.1k	620	430	470	470
R _G (Ω)	910	560	390	120	51	1.1k	620	430	120	51
-3dB BW (MHz)	200	160	145	70	30	185	145	130	70	30

Table 1b. MAX4189 Recommended Component Values

COMPONENT/ BW	DUAL SUPPLIES			SINGLE SUPPLY		
	Av = +1V/V			Av = +1V/V		
	R _L = 1kΩ	R _L = 150Ω	R _L = 100Ω	R _L = 1kΩ	R _L = 150Ω	R _L = 100Ω
R _G (Ω)	1.6k	1.1k	680	1.5k	1.6k	910
-3dB BW (MHz)	250	210	185	230	190	165

Table 1c. MAX4190 Recommended Component Values

COMPONENT/ BW	DUAL SUPPLIES					SINGLE SUPPLY				
	Av = +2V/V			Av = +5 (V/V)	Av = +10 (V/V)	Av = +1V/V			Av = +5 V/V	Av = +10 V/V
	R _L = 1kΩ	R _L = 150Ω	R _L = 100Ω	R _L = 1kΩ	R _L = 1kΩ	R _L = 1kΩ	R _L = 150Ω	R _L = 100Ω	R _L = 1kΩ	R _L = 1kΩ
R _F (Ω)	1.3k	680	510	470	470	1.5k	750	510	470	470
R _G (Ω)	1.3k	680	510	120	51	1.5k	750	510	120	51
-3dB BW (MHz)	185	180	135	70	30	165	135	125	70	30

DC and Noise Errors

Several major error sources must be considered in any op amp. These apply equally to the MAX4188/MAX4189/MAX4190. Offset-error terms are given by the equation below. Voltage and current-noise errors are root-square summed and are therefore computed separately. In Figure 4, the total output offset voltage is determined by the following factors:

- The input offset voltage (V_{OS}) times the closed-loop gain (1 = R_F / R_G).
- The positive input bias current (I_{B+}) times the source resistor (R_S) (usually 50Ω or 75Ω), plus the negative input bias current (I_{B-}) times the parallel combination of R_G and R_F. In current-feedback amplifiers, the input bias currents at the IN+ and IN- terminals do not track each other and may have opposite polarity, so there is no benefit to matching the resistance at both inputs.

The equation for the total DC error at the output is:

$$V_{OUT} = \left[(I_{B+})R_S + (I_{B-})(R_F \parallel R_G) + V_{OS} \right] \left(1 + \frac{R_F}{R_G} \right)$$

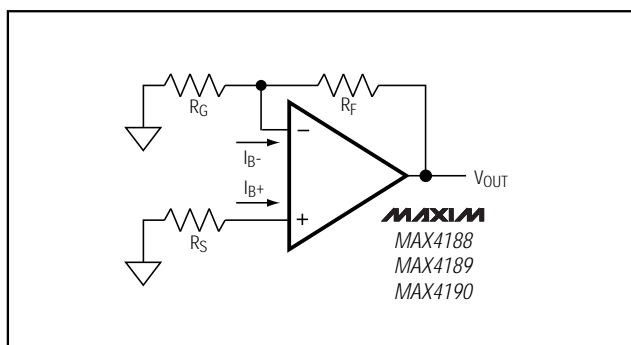

Figure 4. Output Offset Voltage

Single/Triple, Low-Glitch, 250MHz, Current-Feedback Amplifiers with High-Speed Disable

MAX4188/MAX4189/MAX4190

The total output-referred noise voltage is:

$$e_{n(OUT)} = \left(1 + \frac{R_F}{R_G}\right) \times \sqrt{\left[(i_{n+})R_S\right]^2 + \left[(i_{n-})R_F \parallel R_G\right]^2 + (e_n)^2}$$

The MAX4188/MAX4189/MAX4190 have a very low, 2nV/√Hz noise voltage. The current noise at the positive input (i_{n+}) is 4pA/√Hz, and the current noise at the inverting input is 5pA/√Hz.

An example of the DC error calculations, using the MAX4188 typical data and typical operating circuit where $R_F = R_G = 560k\Omega$ ($R_F \parallel R_G = 280\Omega$), and $R_S = 37.5\Omega$, gives the following:

$$V_{OUT} = \left[\frac{(1 \times 10^{-6}) \times 37.5 + (2 \times 10^{-6}) \times 280}{1 + 1.5 \times 10^{-3}} \right] \times (1+1)$$

$V_{OUT} = 4.1mV$

Calculating the total output noise in a similar manner yields:

$$e_{n(OUT)} = (1+1) \sqrt{\left(4 \times 10^{-12} \times 37.5\right)^2 + \left(5 \times 10^{-12} \times 280\right)^2 + \left(2 \times 10^{-9}\right)^2}$$

$e_{n(OUT)} = 4.8nV/\sqrt{Hz}$

With a 200MHz system bandwidth, this calculates to 68μVRMS (approximately 408μVp-p, choosing the six-sigma value).

Video Line Driver

The MAX4188/MAX4189/MAX4190 are well suited to drive coaxial transmission lines when the cable is terminated at both ends (Figure 5). Cable frequency response can cause variations in the signal's flatness. See Table 1 for optimum R_F and R_G values.

Driving Capacitive Loads

The MAX4188/MAX4189/MAX4190 are optimized for AC performance. Reactive loads decrease phase margin and may produce excessive ringing and oscillation. Unlike most high-speed amplifiers, the MAX4188/MAX4189/MAX4190 are tolerant of capacitive loads up to 50pF. Capacitive loads greater than 50pF may cause ringing and oscillation. Figure 6a shows a circuit that eliminates this problem. Placing the small (usually 15Ω to 33Ω) isolation resistor, R_S , before the reactive load prevents ringing and oscillation. At higher capacitive loads, the interaction of the load capacitance and isolation resistor controls AC performance. Figures 6b and 6c show the MAX4188 and MAX4189 frequency response with a 100pF capacitive load. Note that in each case, gain peaking is substantially reduced when the 20Ω resistor is used to isolate the capacitive load from the amplifier output.

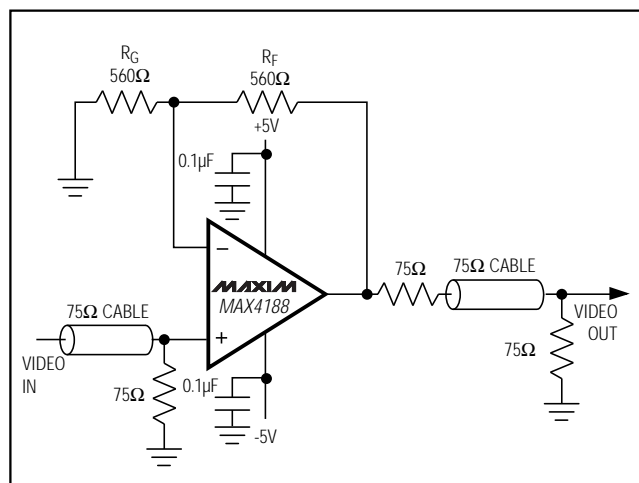

Figure 5. Video Line Driver Application

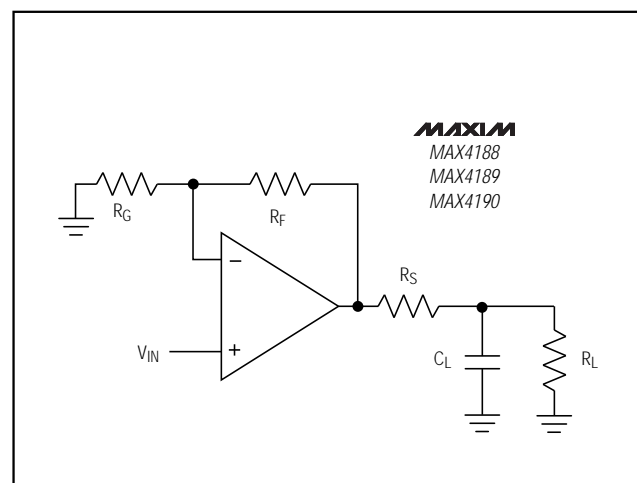

Figure 6a. Using an Isolation Resistor (R_S) for High Capacitive Loads

Single/Triple, Low-Glitch, 250MHz, Current-Feedback Amplifiers with High-Speed Disable

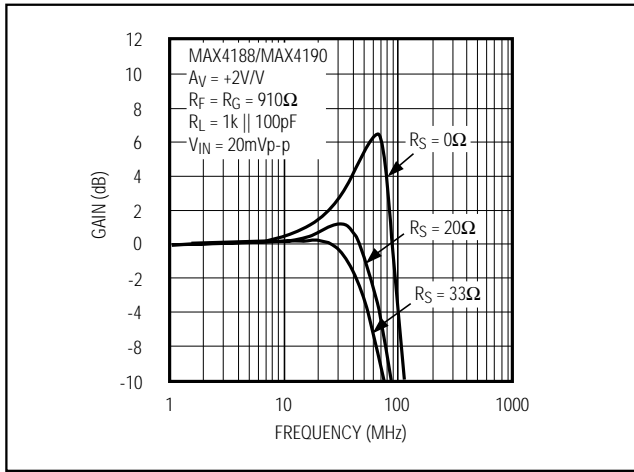

Figure 6b. Normalized Frequency Response with 100pF Capacitive Load

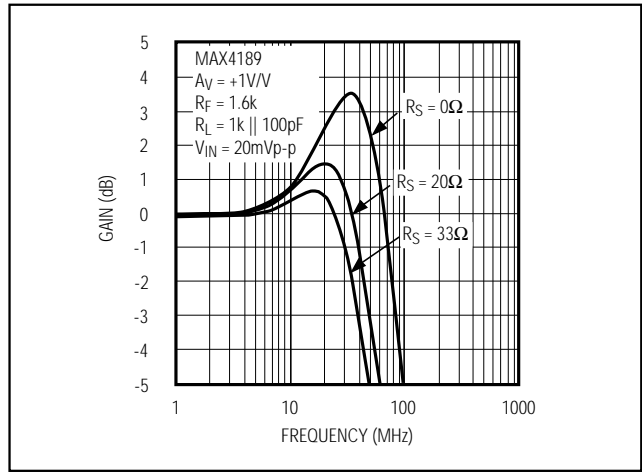

Figure 6c. Normalized Frequency Response with 100pF Capacitive Load

Chip Information

MAX4188/4189
 TRANSISTOR COUNT: 336
 MAX4190
 TRANSISTOR COUNT: 112
 SUBSTRATE CONNECTED TO V_{EE}

Ordering Information (continued)

PART	TEMP. RANGE	PIN-PACKAGE
MAX4189 ESD	-40°C to +85°C	14 SO
MAX4189EEE	-40°C to +85°C	16 QSOP
MAX4190 ESD	-40°C to +85°C	8 SO
MAX4190EEE	-40°C to +85°C	8 μMAX

Pin Configurations

