

PNP Silicon AF Transistor

BCP 69

- For general AF application
- High collector current
- High current gain
- Low collector-emitter saturation voltage
- Complementary type: BCP 68 (NPN)

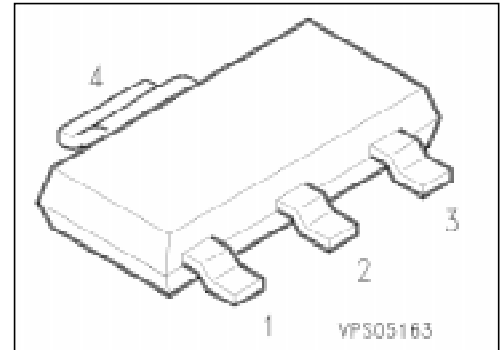

| Type | Marking | Ordering Code (tape and reel) | Pin Configuration | | | | Package ¹⁾ |
|-----------|-----------|----------------------------------|-------------------|---|---|---|-----------------------|
| | | | 1 | 2 | 3 | 4 | |
| BCP 69 | BCP 69 | Q62702-C2130 | B | C | E | C | SOT-223 |
| BCP 69-10 | BCP 69-10 | Q62702-C2131 | | | | | |
| BCP 69-16 | BCP 69-16 | Q62702-C2132 | | | | | |
| BCP 69-25 | BCP 69-25 | Q62702-C2133 | | | | | |

Maximum Ratings

| Parameter | Symbol | Values | Unit |
|---|------------------------|----------------|------|
| Collector-emitter voltage | V_{CE0} | 20 | V |
| | V_{CES} | 25 | |
| | Collector-base voltage | V_{CB0} | |
| Emitter-base voltage | V_{EB0} | 5 | |
| Collector current | I_C | 1 | A |
| Peak collector current | I_{CM} | 2 | |
| Base current | I_B | 100 | mA |
| Peak base current | I_{BM} | 200 | |
| Total power dissipation, $T_s = 124\text{ °C}^2)$ | P_{tot} | 1.5 | W |
| Junction temperature | T_j | 150 | °C |
| Storage temperature range | T_{stg} | - 65 ... + 150 | |

Thermal Resistance

| | | | |
|----------------------------------|-------------|------|-----|
| Junction - ambient ²⁾ | $R_{th JA}$ | ≤ 72 | K/W |
| Junction - soldering point | $R_{th JS}$ | ≤ 17 | |

¹⁾ For detailed information see chapter Package Outlines.

²⁾ Package mounted on epoxy pcb 40 mm × 40 mm × 1.5 mm/6 cm² Cu.

Electrical Characteristics

at $T_A = 25\text{ }^\circ\text{C}$, unless otherwise specified.

| Parameter | Symbol | Values | | | Unit |
|-----------|--------|--------|------|------|------|
| | | min. | typ. | max. | |

DC characteristics

| | | | | | |
|---|---------------|------------------------------------|----------------------------------|------------------------------------|---------------------|
| Collector-emitter breakdown voltage $I_C = 30\text{ mA}, I_B = 0$ | $V_{(BR)CE0}$ | 20 | – | – | V |
| Collector-emitter breakdown voltage $I_C = 10\text{ }\mu\text{A}, V_{BE} = 0$ | $V_{(BR)CES}$ | 25 | – | – | |
| Collector-base breakdown voltage $I_C = 10\text{ }\mu\text{A}, I_B = 0$ | $V_{(BR)CB0}$ | 25 | – | – | |
| Emitter-base breakdown voltage $I_E = 10\text{ }\mu\text{A}, I_B = 0$ | $V_{(BR)EB0}$ | 5 | – | – | |
| Collector-base cutoff current $V_{CB} = 25\text{ V}$ $V_{CB} = 25\text{ V}, T_A = 150\text{ }^\circ\text{C}$ | I_{CB0} | – – | – – | 100 100 | nA μA |
| Emitter-base cutoff current $V_{EB} = 5\text{ V}, I_C = 0$ | I_{EB0} | – | – | 100 | nA |
| DC current gain ¹⁾ $I_C = 5\text{ mA}, V_{CE} = 10\text{ V}$ $I_C = 500\text{ mA}, V_{CE} = 1\text{ V}$ $I_C = 1\text{ A}, V_{CE} = 1\text{ V}$ | h_{FE} | 50 85 85 100 160 60 | – – 100 160 250 – | – 375 160 250 375 – | – |
| Collector-emitter saturation voltage ¹⁾ $I_C = 1\text{ A}, I_B = 100\text{ mA}$ | V_{CEsat} | – | – | 0.5 | V |
| Base-emitter voltage ¹⁾ $I_C = 5\text{ mA}, V_{CE} = 10\text{ V}$ $I_C = 1\text{ A}, V_{CE} = 1\text{ V}$ | V_{BE} | – – | 0.6 – | – 1 | |

AC characteristics

| | | | | | |
|--|-------|---|-----|---|-----|
| Transition frequency $I_C = 100\text{ mA}, V_{CE} = 5\text{ V}, f = 100\text{ MHz}$ | f_T | – | 100 | – | MHz |
|--|-------|---|-----|---|-----|

¹⁾ Pulse test conditions: $t \leq 300\text{ }\mu\text{s}, D = 2\text{ }%$.

Total power dissipation $P_{tot} = f(T_A^*; T_S)$

* Package mounted on epoxy

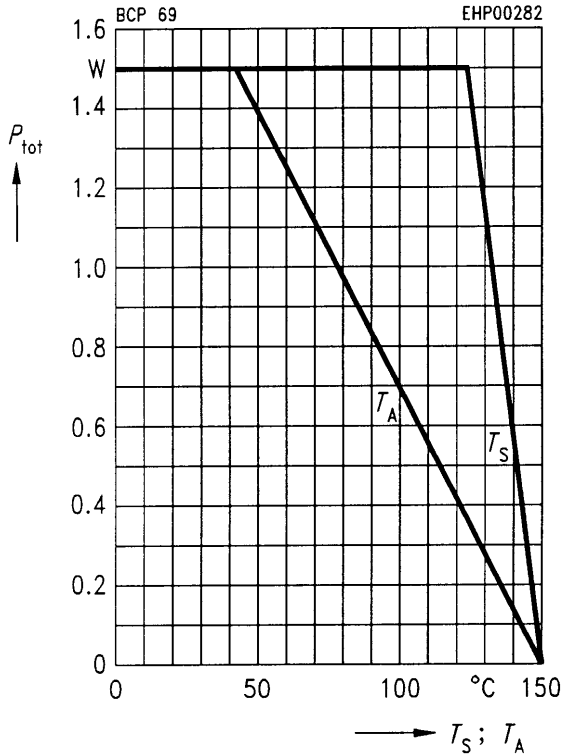

Transition frequency $f_T = f(I_C)$

$V_{CE} = 5 V, f = 100 \text{ MHz}$

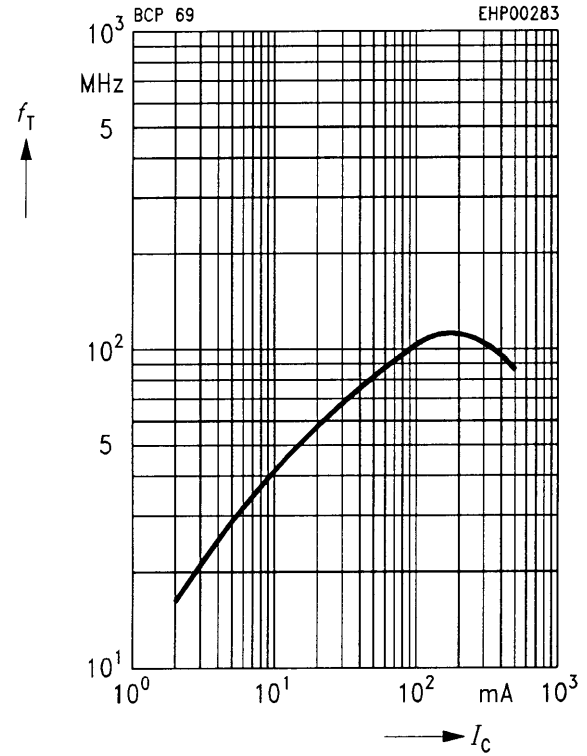

Collector cutoff current $I_{CB0} = f(T_A)$

$V_{CB} = 25 V$

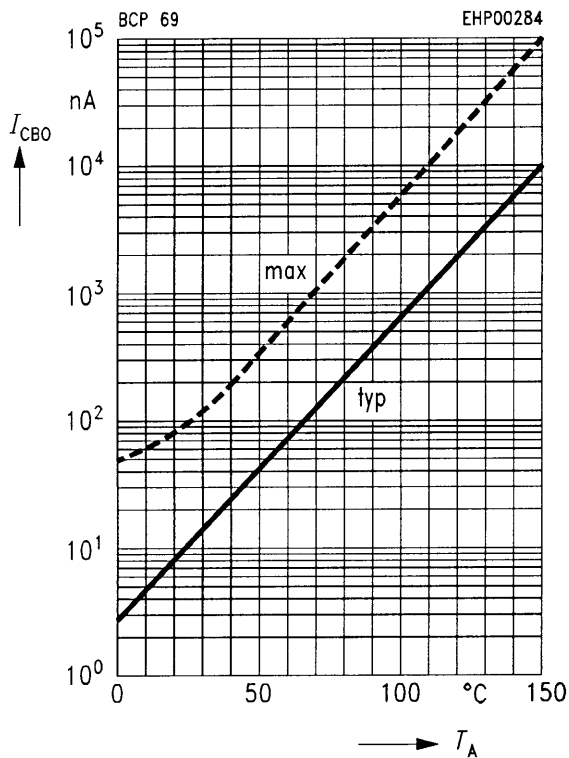

DC current gain $h_{FE} = f(I_C)$

$V_{CB} = 1 V$

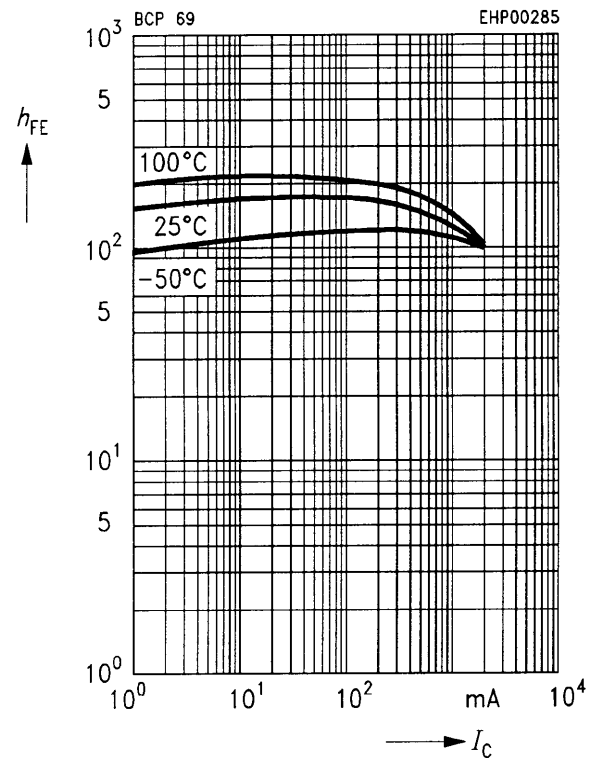

Collector-emitter saturation voltage

$I_C = f(V_{CEsat})$

$h_{FE} = 10$

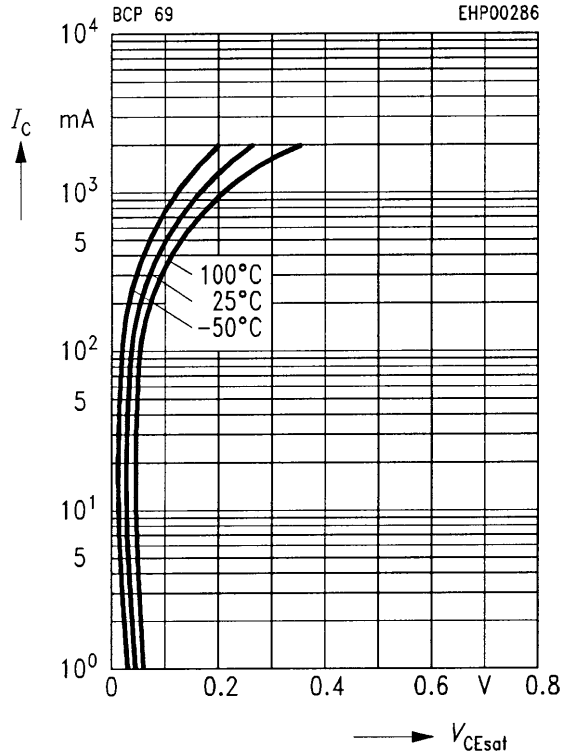

Base-emitter saturation voltage

$I_C = f(V_{BEsat})$

$h_{FE} = 10$

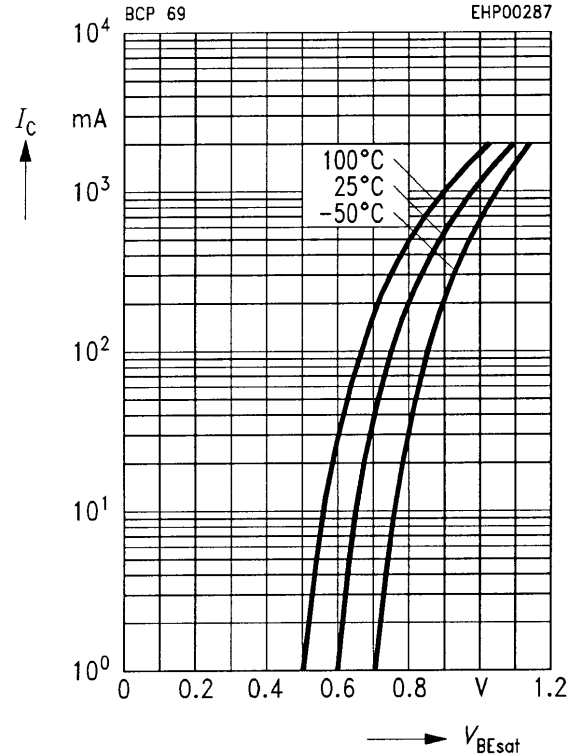

Permissible pulse load $P_{tot max}/P_{tot DC} = f(t_p)$

