

Power unit ICs for pagers

BH6113FV / BH6114FV

The BH6113FV and BH6114FV are power unit ICs with a driver for VFM switching regulator controllers and vibrators, LEDs, and speakers, and a built-in battery ejection sensor. The BH6114FV is a BH6113FV with a modified DC / DC converter output voltage ($V_{OUT} = 2.7V$).

● Applications

Pagers

● Features

- 1) Internal VFM-type CMOS switching regulator and drivers for four channels.
- 2) Equipped with a battery ejection sensor

● Absolute maximum ratings ($T_a = 25^\circ\text{C}$)

Parameter	Symbol	Limits	Unit
Power supply voltage	+B	-0.3~+6.0	V
Driver output applied voltage	V_{Max}	-0.3~+7.0	V
Power dissipation	P_d	350*	mW
Maximum driver output current (1)	I_{OM1}	350	mA
Maximum driver output current (2)	I_{OM2}	250	mA
Maximum driver output current (3)	I_{OM3}	150	mA
Maximum driver output current (4)	I_{OM4}	10	mA
Operating temperature	T_{opr}	-15~+60	$^\circ\text{C}$
Storage temperature	T_{stg}	-55~+125	$^\circ\text{C}$

* Reduced by 3.5 mW for each increase in T_a of 1°C over 25°C .

● Recommended operating conditions

Parameter	Symbol	Limits	Unit
Power supply voltage	+B	0.9~1.7	V
Driver unit operation frequency	f_{drv}	DC~100*	kHz

* The driver operation frequency does not include the motor unit.

● Block diagram

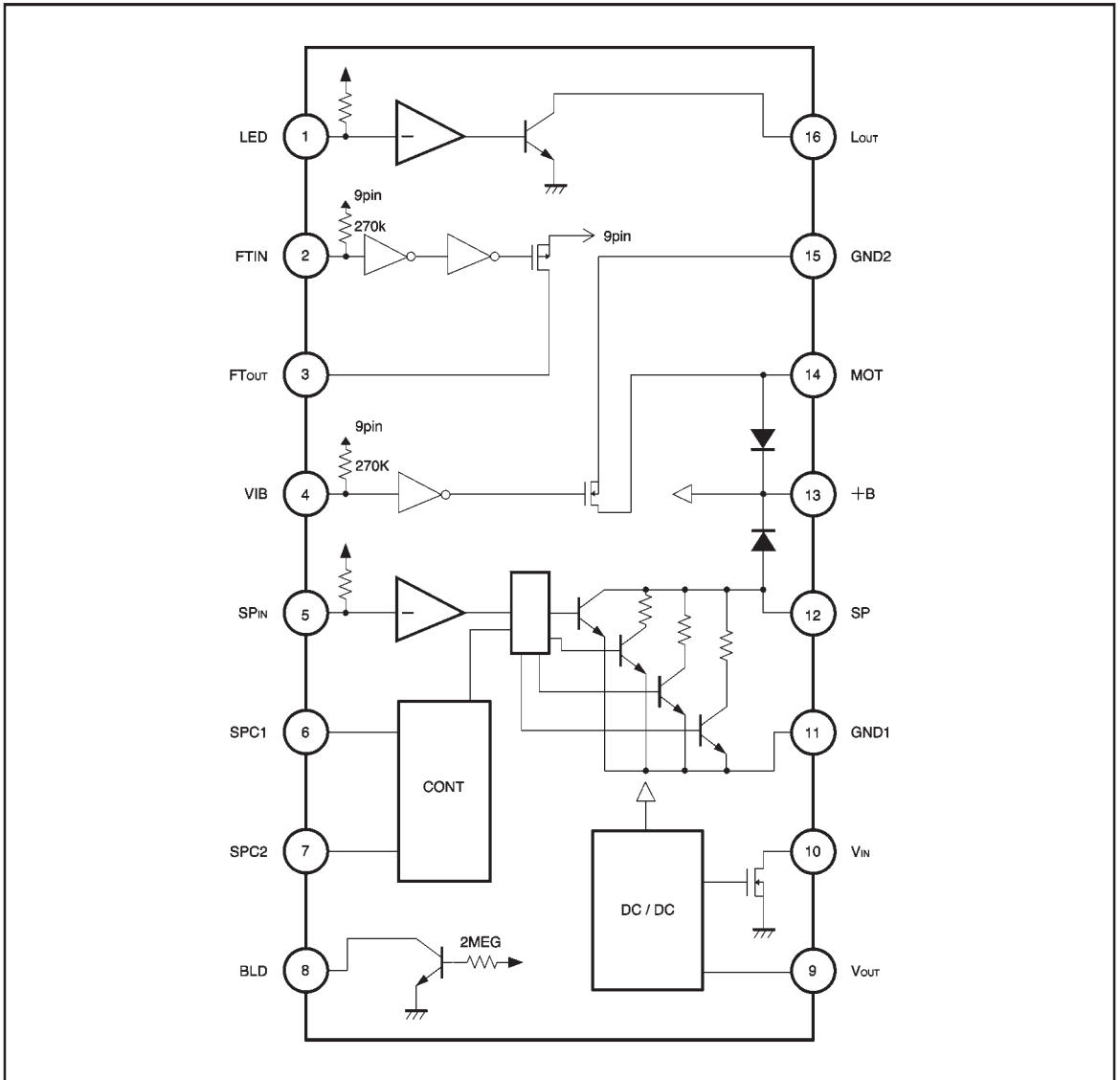

● Pin descriptions

Pin No.	Pin name	I / O	Pin voltage	Internal equivalent circuit	Function
11	GND 1	I	GND	—————	Grounding pin
15	GND 2	I			
13	+B	I	+B	—————	Battery pin
1	LED	I	+B (OPEN)		Driver input pin Low: act High(OPEN): Output HIGH-Z
5	SPIN	I			
2	FTIN	I	—————		Driver input pin Low: act High (OPEN): Output HIGH-Z Driver output pin (internal diode for surge absorption)
3	FTOUT	O	—————		
4	VIB	I	—————		Driver input pin Low: act High (OPEN): Output HIGH-Z
6	SPC 1	I	—————		Volume control pin 1 Volume control pin 2 Low: act OPEN: undefined High: Output HIGH-Z
7	SPC 2	I			

Pin No.	Pin name	I / O	Pin voltage	Internal equivalent circuit	Function
8	BLD	O	—		Battery ejection voltage detection pin *1 (When battery is removed: HIGH) Current consumption 1.5 V system: 0.45 μ A
9	V _{OUT}	O	3V		DC / DC converter output pin
10	V _{IN}	I	—		DC / DC converter switching pin (internal rectifier diode)
12	SP	O	—		Driver output pin
14	MOT	O	—		Driver output pin
16	Lout	O	—		Driver output pin

*1 Operation theory for battery ejection circuit

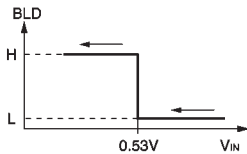

●Electrical characteristics (unless otherwise noted, Ta = 25°C, + B = 1.5V)

Parameter	Symbol	Min.	Typ.	Max.	Unit	Conditions	Measurement Circuit	
〈Overall circuit〉								
Current dissipation	I _{IN}	—	11	20	μA	With no load on DC / DC converter and all drives off, BLDOUT=OPEN	Fig.1	
〈DC-DC converter unit〉								
Output voltage	BH6113FV	V _{OUT}	2.90	3.00	3.10	V	I _{OUT} =4.0mA	Fig.1
	BH6114FV		2.63	2.70	2.77	V	I _{OUT} =4.0mA	Fig.1
Output voltage temperature change ratio	ΔV _{OUT}	—	-0.2	—	mV/°C	Ta=-20~+65°C	Fig.1	
Operation initiation power supply voltage	V _{ST}	—	0.80	0.90	V	R _{OUT} =680Ω, V _{CC} ; 0V→1.7V	Fig.1	
Operation sustain power supply voltage	V _{hid}	—	0.70	0.80	V	R _{OUT} =680Ω, V _{CC} ; 1.7V→0V	Fig.1	
Input voltage supply stability	ΔV _{O1}	—	10	100	mV	I _{OUT} =4.0mA, V _{CC} ; 0.9~1.7V	Fig.1	
Load regulation	ΔV _{O2}	—	5	100	mV	I _{OUT} =2.0~4.0mA	Fig.1	
Oscillation duty ratio	Df _{Max.}	—	85	—	%	At maximum oscillation frequency	Fig.1	
Maximum oscillation frequency	f _{osc}	—	100	140	kHz	—	Fig.1	
Efficiency 1 (light load)	η ₁	70	75	—	%	I _{OUT} =100μA	Fig.1	
Efficiency 2 (medium load)	η ₂	70	80	—	%	I _{OUT} =1mA	Fig.1	
Efficiency 3 (heavy load)	η ₃	70	80	—	%	I _{OUT} =4mA	Fig.1	
〈Battery ejection circuit unit〉								
BLD detection voltage	V _{BLD}	0.48	0.53	0.58	V	+B value at BLDOUT=1.35V, R _{BLD} =3MΩ	Fig.1	
Output high level voltage	VOH	2.7	3.0	—	V	R _{BLD} =3MΩ	Fig.1	
Output low level voltage	VOL	—	0.1	0.4	V	R _{BLD} =3MΩ	Fig.1	
〈Vibrator control unit〉								
Maximum output drive system	I _{OM1}	300	—	—	mA	V _{sat} ≤0.5V	Fig.1	
Drive output voltage	V _{sat1}	—	0.18	0.36	V	I _{OUT} =180mA	Fig.1	
Leakage current when off	I _{L1}	—	0.0	5.0	μA	V _{OUT} =5V	Fig.1	
〈Speaker control unit〉								
Line current when off	I _{o2}	4.5	8.0	15.5	mA	For loud volume	Fig.1	
Maximum drive current / loud volume	I _{OM2}	200	—	—	mA	V _{sat} ≤0.5V	Fig.1	
Drive output voltage / loud volume	V _{sat2A}	—	0.10	0.20	V	I _{OUT} =100mA (Z=1Ω)	Fig.1	
Drive output voltage / ordinary volume	V _{sat2B}	0.12	0.22	0.32	V	I _{OUT} =10mA (Z=22Ω)	Fig.1	
Drive output voltage / medium volume	V _{sat2C}	0.10	0.19	0.30	V	I _{OUT} =5mA (Z=38Ω)	Fig.1	
Drive output voltage / low volume	V _{sat2D}	0.03	0.11	0.23	V	I _{OUT} =1mA (Z=110Ω)	Fig.1	
Leakage current when off	I _{L2}	—	0.0	5.0	μA	V _{OUT} =5V	Fig.1	
Input threshold level	V _{Th2}	+B -0.85V	—	—	V	—	Fig.1	
Input current	I _{IN2}	11	23	35	μA	V _{IN} =+B-0.85V	Fig.1	

©Not designed for radiation resistance.

Parameter	Symbol	Min.	Typ.	Max.	Unit	Conditions	Measurement Circuit
〈LED control unit〉							
Circuit current when on	$I_{\alpha 3}$	2.5	4.5	8.0	mA	—	Fig.1
Maximum output drive current	I_{om3}	100	—	—	mA	$V_{sat} \leq 0.5V$	Fig.1
Drive output voltage	V_{sat3}	—	0.1	0.2	V	$I_{out} = 40mA$	Fig.1
Leakage current when off	I_{L3}	—	0.0	5.0	μA	$V_{OUT} = 5V$	Fig.1
Input threshold level	V_{TH3}	$\frac{+B}{-0.85V}$	—	—	V	—	Fig.1
Input current	I_{in3}	11	23	35	μA	$V_{IN} = \frac{+B}{-0.85V}$	Fig.1
〈Photocoupler drive unit〉							
Maximum output drive current	I_{om4}	5	—	—	mA	$V_{sat} \leq 0.5V$	Fig.1
Drive output voltage	V_{sat4}	—	0.1	0.2	V	$I_{out} = 3mA$	Fig.1
Leakage current when off	I_{L4}	—	0.0	5.0	μA	$V_{OUT} = 5V$	Fig.1
Pull-up resistance 4	R_{in4}	190	270	350	k Ω	—	Fig.1

©Not designed for radiation resistance.

Speaker unit logic table

Pin	Volume			
	High	Medium (high)	Medium (low)	Low
SPC1	LOW	HIGH	LOW	HIGH
SPC2	LOW	LOW	HIGH	HIGH

● Measurement circuits

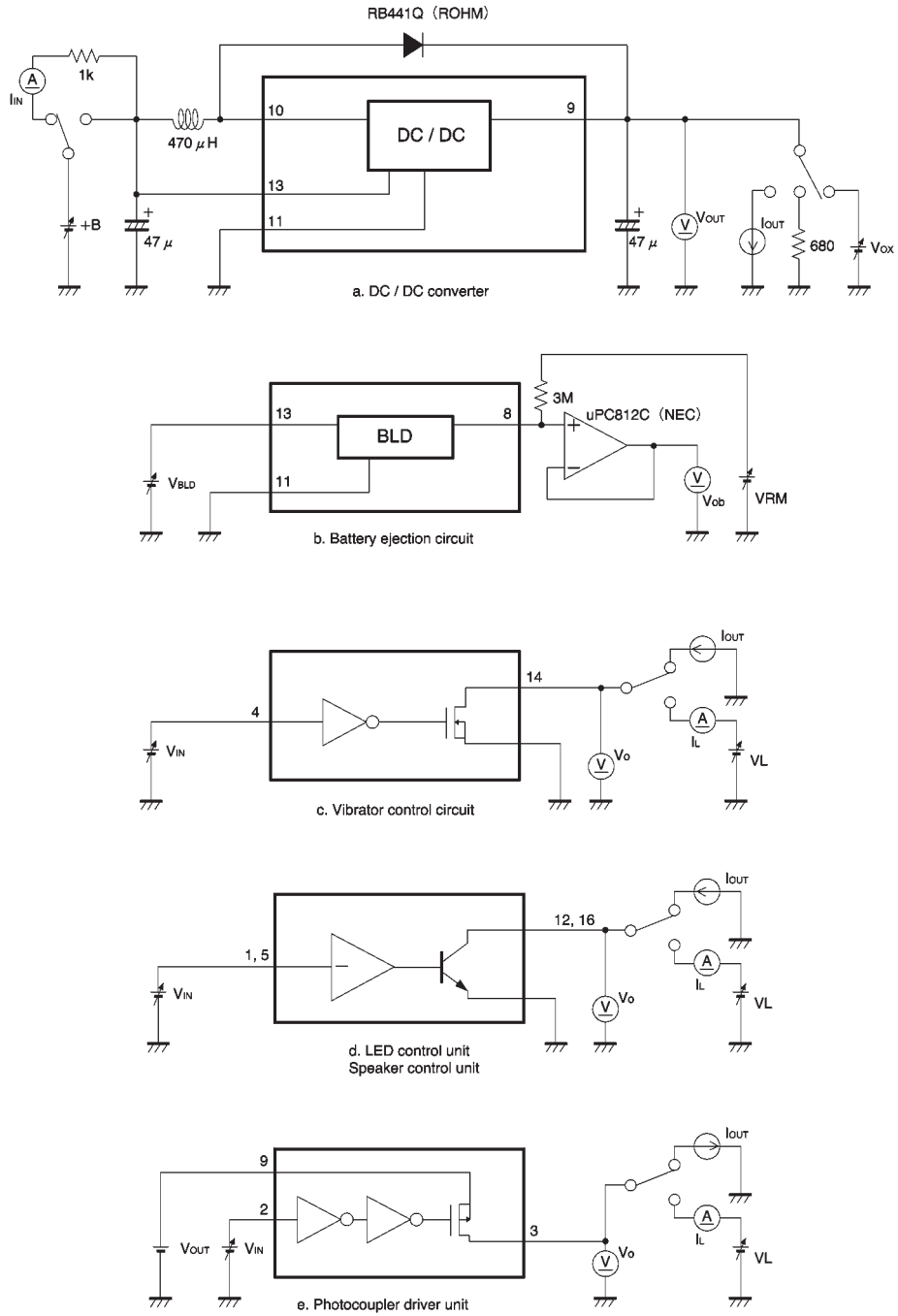

Fig.1

●Electrical characteristic curves

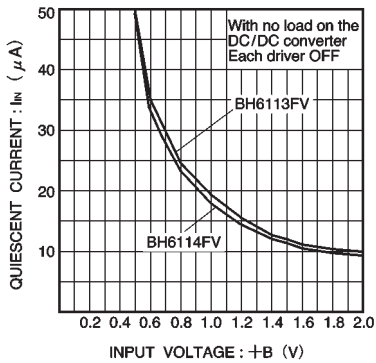

Fig.3 Quiescent current (at no load) vs. input voltage

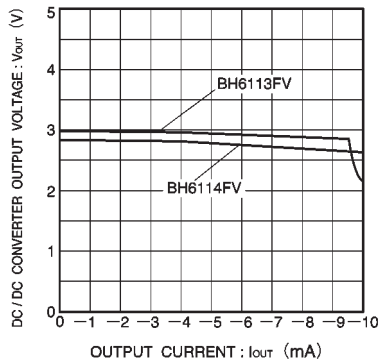

Fig.4 DC / DC converter unit: load regulation

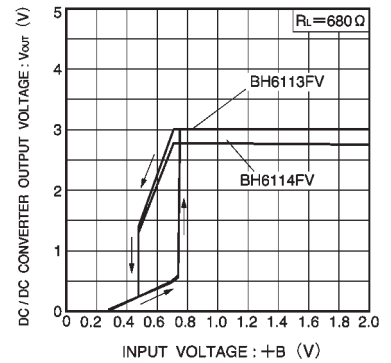

Fig.5 DC / DC converter unit: line regulation

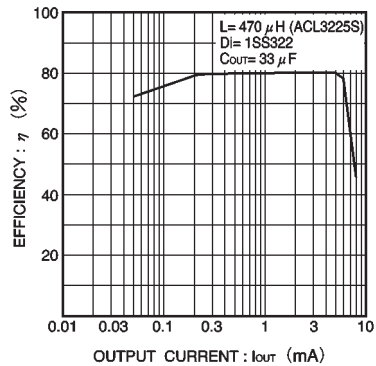

Fig.6 DC / DC converter unit efficiency vs. load current

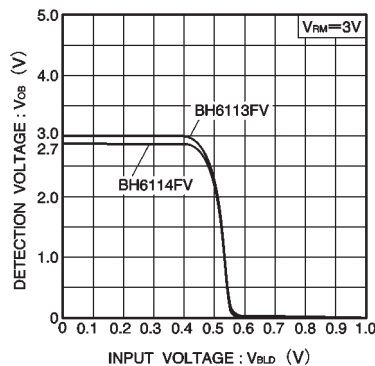

Fig.7 BLD detection voltage

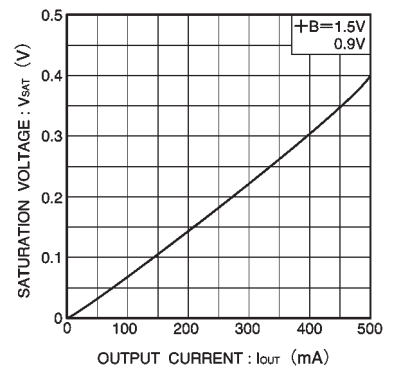

Fig.8 Vibrator control unit: saturation voltage vs. output current

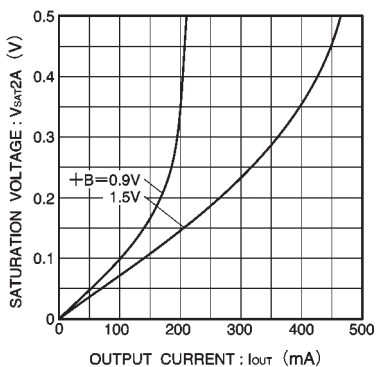

Fig.9 Speaker control unit (loud volume) : saturation voltage vs. output current

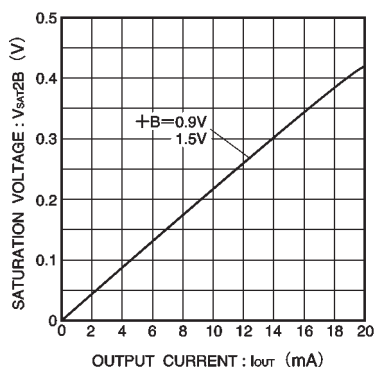

Fig.10 Speaker control unit (normal volume) : saturation voltage vs. output current

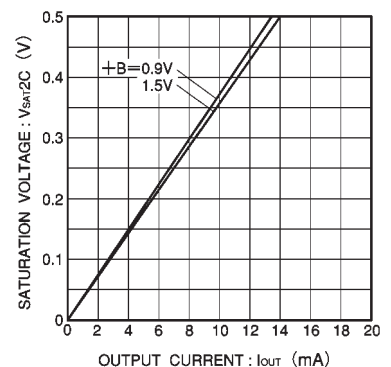

Fig.11 Speaker control unit (medium volume) : saturation voltage vs. output current

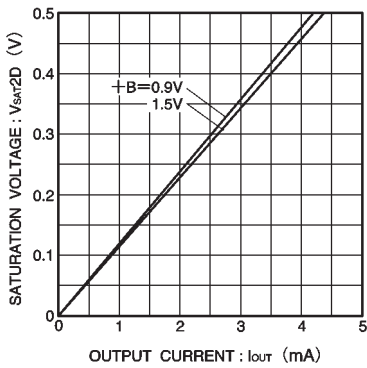

Fig.12 Speaker control unit (low volume)
: saturation voltage vs. output current

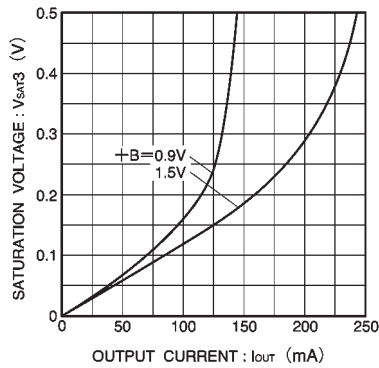

Fig.13 LED control unit: saturation
voltage vs.output current

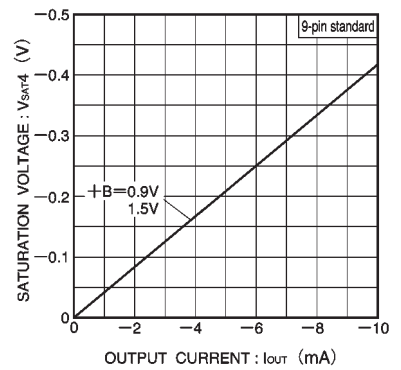

Fig.14 Photocoupler driver control unit
: saturation voltage vs. output current

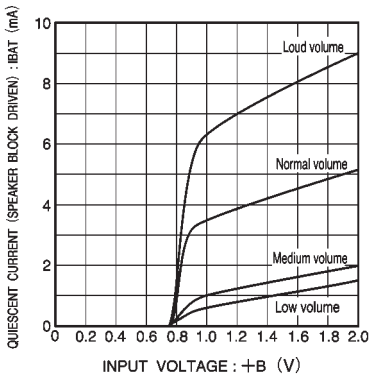

Fig.15 Speaker control unit: quiescent current
(when on) vs.input voltage

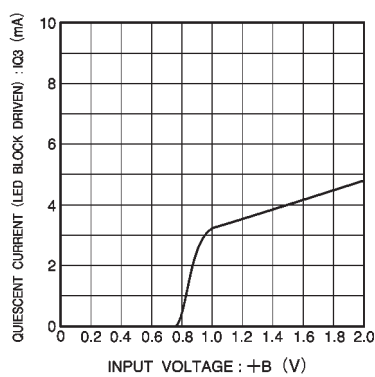

Fig.16 LED control unit: quiescent current
(when on) vs. input voltage

● External dimensions (Units: mm)

