

Features

- High speed switching
- VCEO(sus)=400V
- Suitable for Switching Regulator and Motor Control

Ordering Information

Type NO.	Marking	Package Code
STD13005F	STD13005	TO-220F

Outline Dimensions

unit : mm

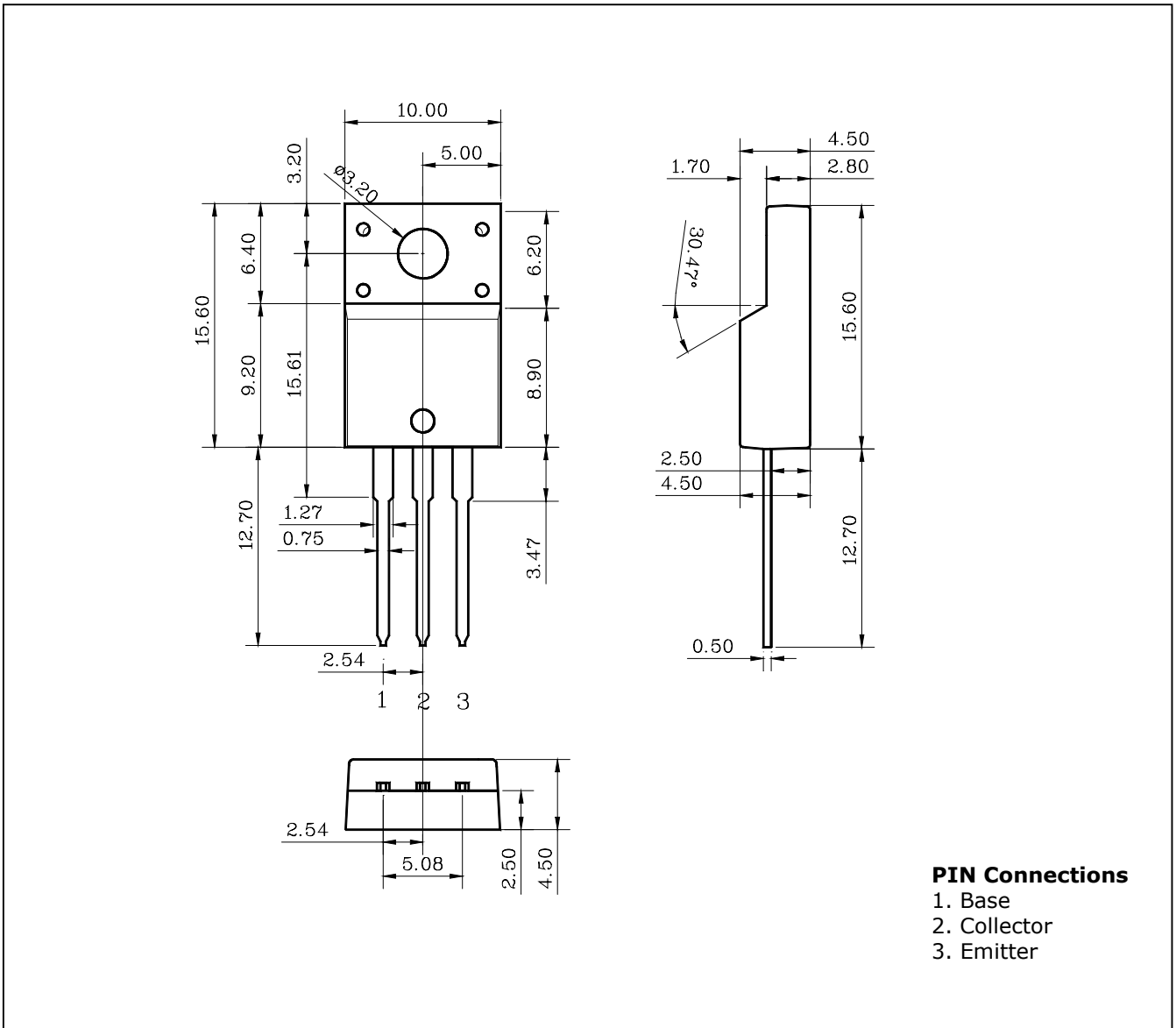

Absolute maximum ratings

(Tc=25°C)

Characteristic	Symbol	Ratings	Unit
Collector-Base voltage	V _{CBO}	700	V
Collector-Emitter voltage	V _{CEO}	400	V
Emitter-base voltage	V _{EBO}	9	V
Collector current (DC)	I _C	4	A
Collector current (Pulse)	I _{CM}	8	A
Base current (DC)	I _B	2	A
Base current (Pulse)	I _{BM}	4	A
Total Power dissipation (Tc=25°C)	P _D	30	W
Junction temperature	T _j	150	°C
Storage temperature	T _{stg}	-55~150	°C

Electrical Characteristics

(Tc=25°C)

Characteristic	Symbol	Test Condition	Min.	Typ.	Max.	Unit
Collector-Emitter sustaining voltage	V _{CE(sus)}	I _C =10mA, I _B =0	400	-	-	V
Collector cut-off current	I _{CEV}	V _{CEV} =Rated Value V _{BE(off)} =1.5V	-	-	1	mA
Emitter cut-off current	I _{EBO}	V _{EB} =9V, I _C =0	-	-	1	mA
DC Current gain	h _{FE} *	I _C =1A, V _{CE} =5V	10	-	60	
		I _C =2A, V _{CE} =5V	8	-	40	
Collector-Emitter saturation voltage	V _{CE(sat)} *	I _C =1A, I _B =0.2A	-	-	0.5	V
		I _C =2A, I _B =0.5A	-	-	0.6	
		I _C =4A, I _B =1A	-	-	1	
Base-Emitter saturation voltage	V _{BE(sat)} *	I _C =1A, I _B =0.2A	-	-	1.2	V
		I _C =2A, I _B =0.5A	-	-	1.6	
Transition frequency	f _T	V _{CB} =10V, I _C =0.5A, f=1MHz	4	-	-	MHz
Output capacitance	C _{ob}	V _{CB} =10V, I _E =0, f=0.1MHz	-	65	-	pF
Turn on Time	t _{ON}	V _{CC} =125V, I _C =2A, R _L =62.5Ω I _{B1} =-I _{B2} =0.4A	-	-	0.8	μs
Storage Time	t _{STG}		-	-	4	
Fall Time	t _F		-	-	0.9	

* Pulse test: PW ≤ 300 μs, Duty cycle ≤ 2% Pulse

Electrical Characteristic Curves

Fig. 1 $P_D - T_C$

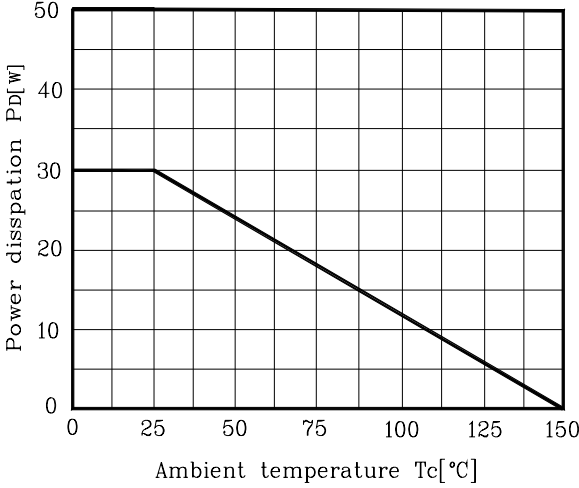

Fig. 2 $V_{BE(sat)}, V_{CE(sat)} - I_C$

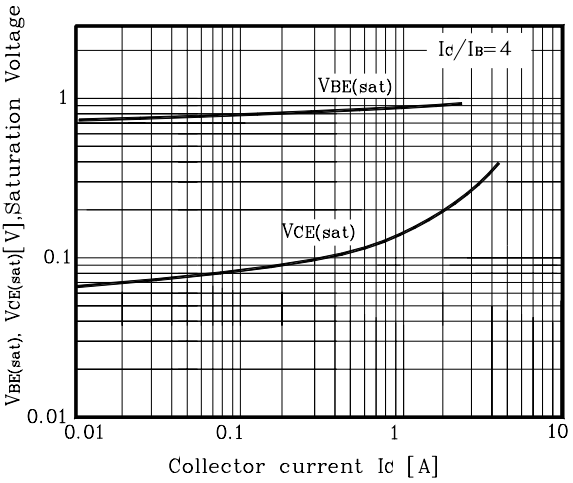

Fig. 3 $h_{FE} - I_C$

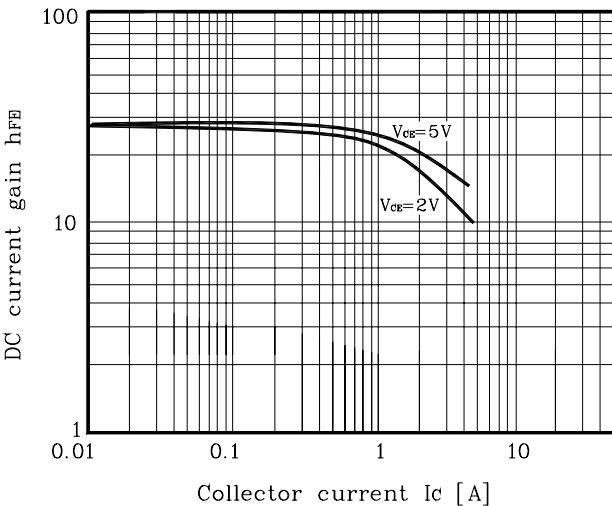

Fig. 4 Turn off time

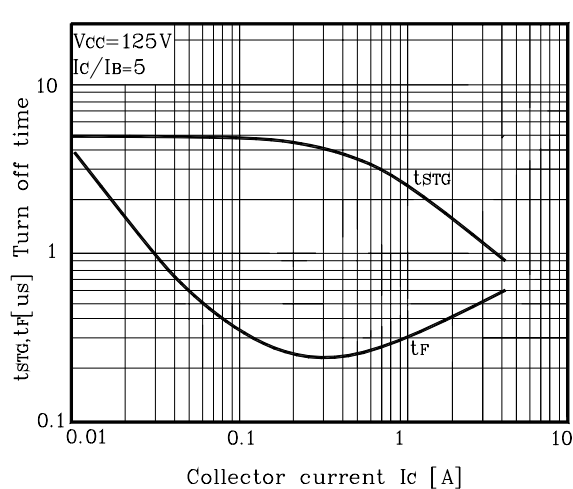

Fig. 5 Turn on time

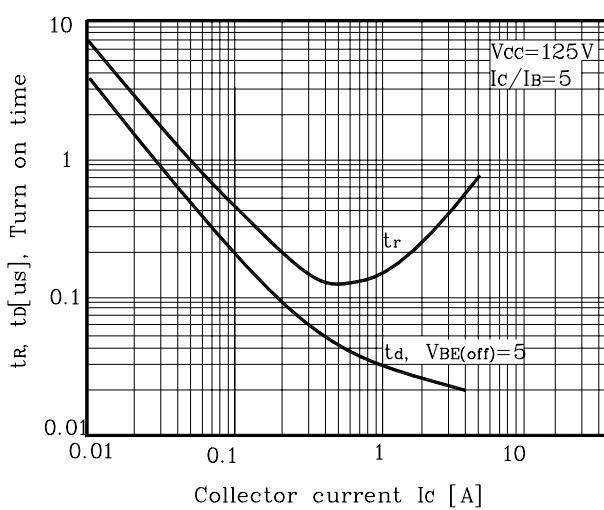

Fig. 6 Capacitance

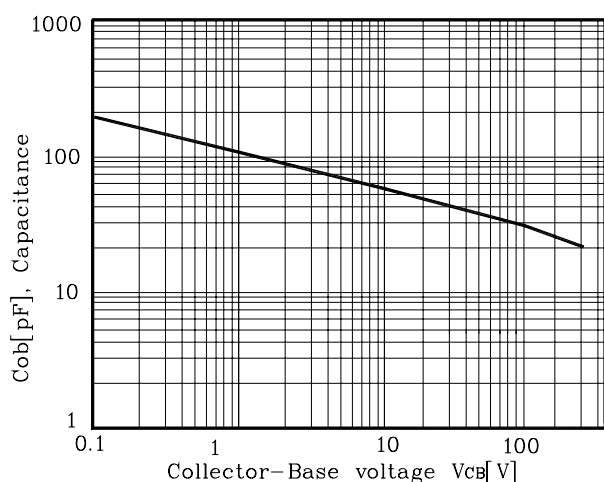

Fig. 7 Safe Operating Area

