

74ALVCH2245

Low Voltage Bidirectional Transceiver with Bushold and 26Ω Series Resistors in B Outputs

General Description

The ALVCH2245 contains eight non-inverting bidirectional buffers with 3-STATE outputs and is intended for bus oriented applications. The T/R input determines the direction of data flow. The OE input disables both the A and B Ports by placing them in a high impedance state. The ALVCH2245 data inputs include active bushold circuitry, eliminating the need for external pull-up resistors to hold unused or floating data inputs at a valid logic level.

The 74ALVCH2245 is designed for low voltage (1.65V to 3.6V) V_{CC} applications. The ALVCH2245 is also designed with 26Ω series resistance in the B Port outputs. This design reduces line noise in applications such as memory address drivers, clock drivers, and bus transceivers transmitters.

The 74ALVCH2245 is fabricated with an advanced CMOS technology to achieve high-speed operation while maintaining low CMOS power dissipation.

Features

- 1.65V to 3.6V V_{CC} supply operation
- 3.6V tolerant control inputs
- Bushold on data inputs eliminates the need for external pull-up/pull-down resistors
- 26Ω series resistors in B Port outputs
- t_{PD} (A to B)
 - 4.9 ns max for 3.0V to 3.6V V_{CC}
 - 6.1 ns max for 2.3V to 2.7V V_{CC}
 - 9.8 ns max for 1.65V to 1.95V V_{CC}
- Uses patented Quiet Series™ noise/EMI reduction circuitry
- Latchup conforms to JEDEC JED78
- ESD performance:
 - Human body model > 2000V
 - Machine model > 200V

Ordering Code:

Order Number	Package Number	Package Description
74ALVCH2245WM	M20B	20-Lead Small Outline Integrated Circuit (SOIC), JEDEC MS-013, 0.300" Wide
74ALVCH2245MTC	MTC20	20-Lead Thin Shrink Small Outline Package (TSSOP), JEDEC MO-153, 4.4mm Wide

Devices also available in Tape and Reel. Specify by appending the suffix letter "X" to the ordering code.

Logic Symbol

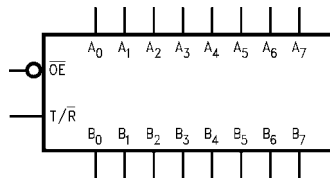

Connection Diagram

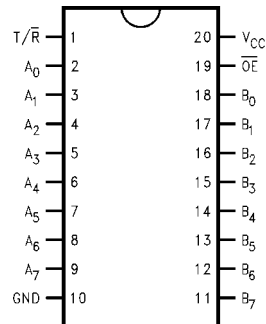

Quiet Series™ is a trademark of Fairchild Semiconductor Corporation.

Pin Descriptions

Pin Names	Description
\overline{OE}	Output Enable Input (Active LOW)
T/\overline{R}	Transmit/Receive Input
A_0-A_7	Side A Bushold Inputs or 3-STATE Outputs
B_0-B_7	Side B Bushold Inputs or 3-STATE Outputs

Truth Table

Inputs		Outputs
\overline{OE}	T/\overline{R}	
L	L	Bus B_0-B_7 Data to Bus A_0-A_7
L	H	Bus A_0-A_7 Data to Bus B_0-B_7
H	X	HIGH Z State on A_0-A_7, B_0-B_7

H = HIGH Voltage Level
 L = LOW Voltage Level
 X = Immaterial
 Z = High Impedance

Logic Diagram

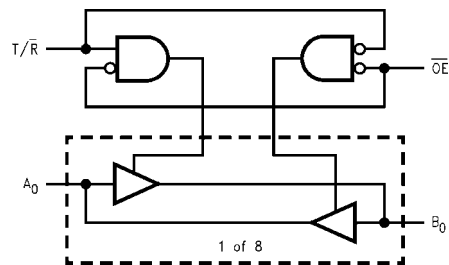

Absolute Maximum Ratings(Note 1)

Supply Voltage (V_{CC})	-0.5V to +4.6V
DC Input Voltage (V_I)	-0.5V to 4.6V
Output Voltage (V_O) (Note 2)	-0.5V to $V_{CC} + 0.5V$
DC Input Diode Current (I_{IK})	
$V_I < 0V$	-50 mA
DC Output Diode Current (I_{OK})	
$V_O < 0V$	-50 mA
DC Output Source/Sink Current (I_{OH}/I_{OL})	± 50 mA
DC V_{CC} or GND Current per Supply Pin (I_{CC} or GND)	± 100 mA
Storage Temperature Range (T_{STG})	-65°C to +150°C

Recommended Operating Conditions (Note 3)

Power Supply	
Operating	1.65V to 3.6V
Input Voltage	0V to V_{CC}
Output Voltage (V_O)	0V to V_{CC}
Free Air Operating Temperature (T_A)	-40°C to +85°C
Minimum Input Edge Rate ($\Delta t/\Delta V$)	
$V_{IN} = 0.8V$ to 2.0V, $V_{CC} = 3.0V$	10 ns/V

Note 1: The Absolute Maximum Ratings are those values beyond which the safety of the device cannot be guaranteed. The device should not be operated at these limits. The parametric values defined in the Electrical Characteristics tables are not guaranteed at the Absolute Maximum Ratings. The "Recommended Operating Conditions" table will define the conditions for actual device operation.

Note 2: I_O Absolute Maximum Rating must be observed.

Note 3: Floating or unused control inputs must be held HIGH or LOW.

DC Electrical Characteristics

Symbol	Parameter	Conditions	V_{CC} (V)	Min	Max	Units
V_{IH}	HIGH Level Input Voltage		1.65 - 1.95 2.3 - 2.7 2.7 - 3.6	$0.65 \times V_{CC}$ 1.7 2.0		V
V_{IL}	LOW Level Input Voltage		1.65 - 1.95 2.3 - 2.7 2.7 - 3.6		$0.35 \times V_{CC}$ 0.7 0.8	V
V_{OH}	HIGH Level Output Voltage A Outputs	$I_{OH} = -100 \mu A$	1.65 - 3.6	$V_{CC} - 0.2$		V
		$I_{OH} = -4$ mA	1.65	1.2		
		$I_{OH} = -6$ mA	2.3	2.0		
		$I_{OH} = -12$ mA	2.3	1.7		
			2.7	2.2		
			3.0	2.4		
	HIGH Level Output Voltage B Outputs	$I_{OH} = -100 \mu A$	1.65 - 3.6	$V_{CC} - 0.2$		
		$I_{OH} = -2$ mA	1.65	1.2		
		$I_{OH} = -4$ mA	2.3	1.9		
		$I_{OH} = -6$ mA	2.3	1.7		
		3.0	2.4			
		$I_{OH} = -8$ mA	2.7	2		
V_{OL}	LOW Level Output Voltage A Outputs	$I_{OL} = 100 \mu A$	1.65 - 3.6		0.2	V
		$I_{OL} = 4$ mA	1.65		0.45	
		$I_{OL} = 6$ mA	2.3		0.4	
		$I_{OL} = 12$ mA	2.3		0.7	
		2.7		0.4		
	$I_{OL} = 24$ mA	3.0		0.55		
	LOW Level Output Voltage B Outputs	$I_{OL} = 100 \mu A$	1.65 - 3.6		0.2	
		$I_{OL} = 2$ mA	1.65		0.45	
		$I_{OL} = 4$ mA	2.3		0.4	
		$I_{OL} = 6$ mA	2.3		0.55	
		3.0		0.55		
		$I_{OL} = 8$ mA	2.7		0.6	
$I_{OL} = 12$ mA		3.0		0.8		
I_I	Input Leakage Current	$0 \leq V_I \leq 3.6V$	1.65 - 3.6		± 5.0	μA

DC Electrical Characteristics (Continued)										
Symbol	Parameter	Conditions	V _{CC} (V)	Min	Max	Units				
I _{I(HOLD)}	Bushold Input Maximum Drive Hold Current	V _{IN} = 0.58V	1.65	25		μA				
		V _{IN} = 1.07V	1.65	-25						
		V _{IN} = 0.7V	2.3	45						
		V _{IN} = 1.7V	2.3	-45						
		V _{IN} = 0.8V V _{IN} = 2.0V 0 < V _O ≤ 3.6V	3.0 3.0 3.6	75 -75	±500					
I _{OZ}	3-STATE Output Leakage	0 ≤ V _O ≤ 3.6V, V _I = V _{IH} or V _{IL}	1.65 - 3.6		±10	μA				
I _{CC}	Quiescent Supply Current	V _I = V _{CC} or GND, I _O = 0	3.6		40	μA				
ΔI _{CC}	Increase in I _{CC} per Input	V _{IH} = V _{CC} - 0.6V	2.7 - 3.6		750	μA				
AC Electrical Characteristics										
Symbol	Parameter	T _A = -40°C to +85°C, R _L = 500Ω								Units
		C _L = 50 pF				C _L = 30 pF				
		V _{CC} = 3.3V ± 0.3V		V _{CC} = 2.7V		V _{CC} = 2.5 ± 0.2V		V _{CC} = 1.8V ± 0.15V		
		Min	Max	Min	Max	Min	Max	Min	Max	
t _{PHL} , t _{PLH}	Propagation Delay A to B	1.1	4.9	1.3	6.1	0.8	5.6	1.5	9.8	ns
	Propagation Delay B to A	1.1	4.0	1.3	4.7	0.8	4.2	1.5	8.4	
t _{PZL} , t _{PZH}	Output Enable Time A to B	1.1	5.5	1.3	7.1	0.8	6.6	1.5	9.8	ns
	Output Enable Time B to A	1.1	5.0	1.3	6.1	0.8	5.6	1.5	9.8	
t _{PLZ} , t _{PHZ}	Output Disable Time A to B	1.1	4.7	1.3	5.2	0.8	4.7	1.5	8.5	ns
	Output Disable Time B to A	1.1	4.1	1.3	4.5	0.8	4.0	1.5	7.2	
Capacitance										
Symbol	Parameter	Conditions	T _A = +25°C		Units					
			V _{CC}	Typical						
C _{IN}	Input Capacitance	V _I = 0V or V _{CC}	3.3	6	pF					
C _{IO}	Input, Output Capacitance	V _O = 0V or V _{CC}	3.3	7	pF					
C _{PD}	Power Dissipation Capacitance	Outputs Enabled	f = 10 MHz, C _L = 50 pF		pF					
			3.3	20						
			2.5	20						

AC Loading and Waveforms

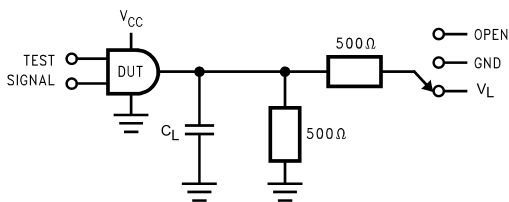

TABLE 1. Values for Figure 1

TEST	SWITCH
t_{PLH}, t_{PHL}	Open
t_{PZL}, t_{PLZ}	V_L
t_{PZH}, t_{PHZ}	GND

FIGURE 1. AC Test Circuit

TABLE 2. Variable Matrix
(Input Characteristics: $f = 1\text{MHz}$; $t_r = t_f = 2\text{ns}$; $Z_O = 50\Omega$)

Symbol	V_{CC}			
	$3.3\text{V} \pm 0.3\text{V}$	2.7V	$2.5 \pm 0.2\text{V}$	$1.8\text{V} \pm 0.15\text{V}$
V_{mi}	1.5V	1.5V	$V_{CC}/2$	$V_{CC}/2$
V_{mo}	1.5V	1.5V	$V_{CC}/2$	$V_{CC}/2$
V_X	$V_{OL} + 0.3\text{V}$	$V_{OL} + 0.3\text{V}$	$V_{OL} + 0.15\text{V}$	$V_{OL} + 0.15\text{V}$
V_Y	$V_{OH} - 0.3\text{V}$	$V_{OH} - 0.3\text{V}$	$V_{OH} - 0.15\text{V}$	$V_{OH} - 0.15\text{V}$
V_L	6V	6V	$V_{CC} * 2$	$V_{CC} * 2$

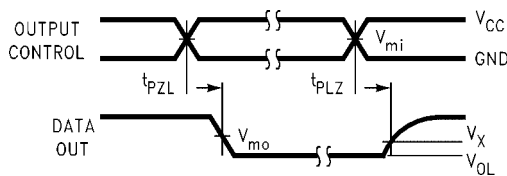

FIGURE 2. Waveform for Inverting and Non-inverting Functions

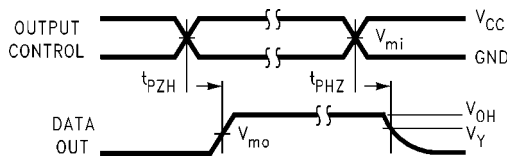

FIGURE 3. 3-STATE Output High Enable and Disable Times for Low Voltage Logic

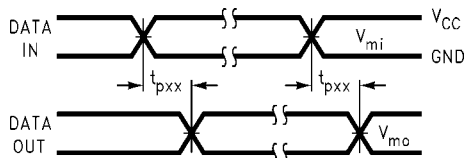
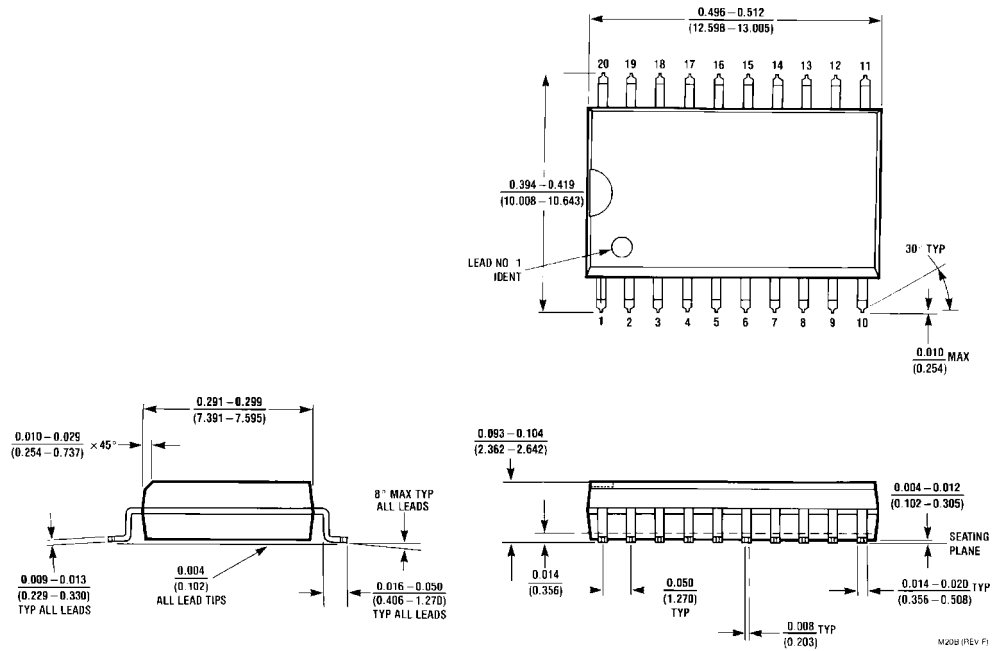

FIGURE 4. 3-STATE Output Low Enable and Disable Times for Low Voltage Logic

Physical Dimensions inches (millimeters) unless otherwise noted



**20-Lead Small Outline Integrated Circuit (SOIC), JEDEC MS-013, 0.300" Wide
Package Number M20B**

