

The RF Line UHF Silicon FET Power Amplifier

Designed specifically for the European Digital Extended Group Special Mobile (GSM) Base Station applications in the 925–960 MHz frequency range. MHW916 operates from a 26 Volt supply and requires 15.5 dBm of RF input power.

- Specified 26 Volt Characteristics
 - RF Input Power: 15.5 dBm Max
 - RF Output Power: 16 Watts at 1.0 dB Compression Point
 - Minimum Gain: 26.5 dB
 - Harmonics: –35 dBc Max at 2Fo
- 50 Ω Input/Output System
- Meet GSM Linearity Specification for Base Station up to 12.5 Watts

MHW916

**16 WATT
925–960 MHz
RF POWER
AMPLIFIER**

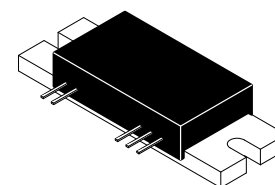

CASE 301AB–02, STYLE 1

MAXIMUM RATINGS

Parameter	Symbol	Value	Unit
DC Supply Voltage	V_S	28	Vdc
DC Bias Voltage	V_B	16	Vdc
RF Input Power	P_{in}	19	dBm
RF Output Power	P_{out}	25	W
Operating Case Temperature Range	T_C	– 5.0 to +85	$^{\circ}C$
Storage Temperature Range	T_{stg}	– 30 to +100	$^{\circ}C$
Standby Current (Pin Removed, $I_{stdby} = I_{S1} + I_{S2}$)	I_{stdby}	400	mA

ELECTRICAL CHARACTERISTICS ($T_C = 25^{\circ}C$, $V_{S1} = V_{S2} = 26$ Vdc, $V_{bias} = 15$ Vdc, 50 ohm system)

Characteristic	Symbol	Min	Typ	Max	Unit
Frequency Range	BW	925	—	960	MHz
Quiescent Current ($P_{in} = 0$ mW)	$I_{dq1} + I_{dq2}$	—	400	—	mA
Power Gain ($P_{out} = 16$ W) (1)	G_p	26.5	30	32.5	dB
Output Power at 1.0 dB Compression	P_{1dB}	16	—	—	W
Efficiency (1.0 dB Compression Power)	η_1	37	44	—	%
Efficiency ($P_{out} = 16$ W) (1)	η_2	33	39	—	%
Input VSWR ($P_{out} = 16$ W) (1)	$VSWR_{in}$	—	—	2:1	—
Harmonic 2 f_o ($P_{out} = 16$ W) (1)	H_2	—	–40	–35	dBc
Harmonic 3 f_o ($P_{out} = 16$ W) (1)	H_3	—	–60	–45	dBc
Ripple ($P_{out} = 16$ W) (1)	R_p	—	1.0	—	dB
Load Mismatch Stress ($P_{out} = 16$ W) Load VSWR = 5:1, All Phase Angles	Ψ	No Degradation in Output Power			
Stability ($P_{out} = 10$ mW to 16 W) Load VSWR = 3:1, All Phase Angles (Except Harmonics)	—	All Spurious Outputs More Than 60 dB Below Desired Signal			
Stability ($P_{out} = -5.0$ dBm to 42 dBm, $f = 925$ to 960 MHz) Load VSWR = 2:1, All Phase Angles	—	All Spurious Outputs Lower Than –46 dBm or –85 dBc (Whichever the Higher)			

(1) Adjust P_{in} for Specified P_{out} .

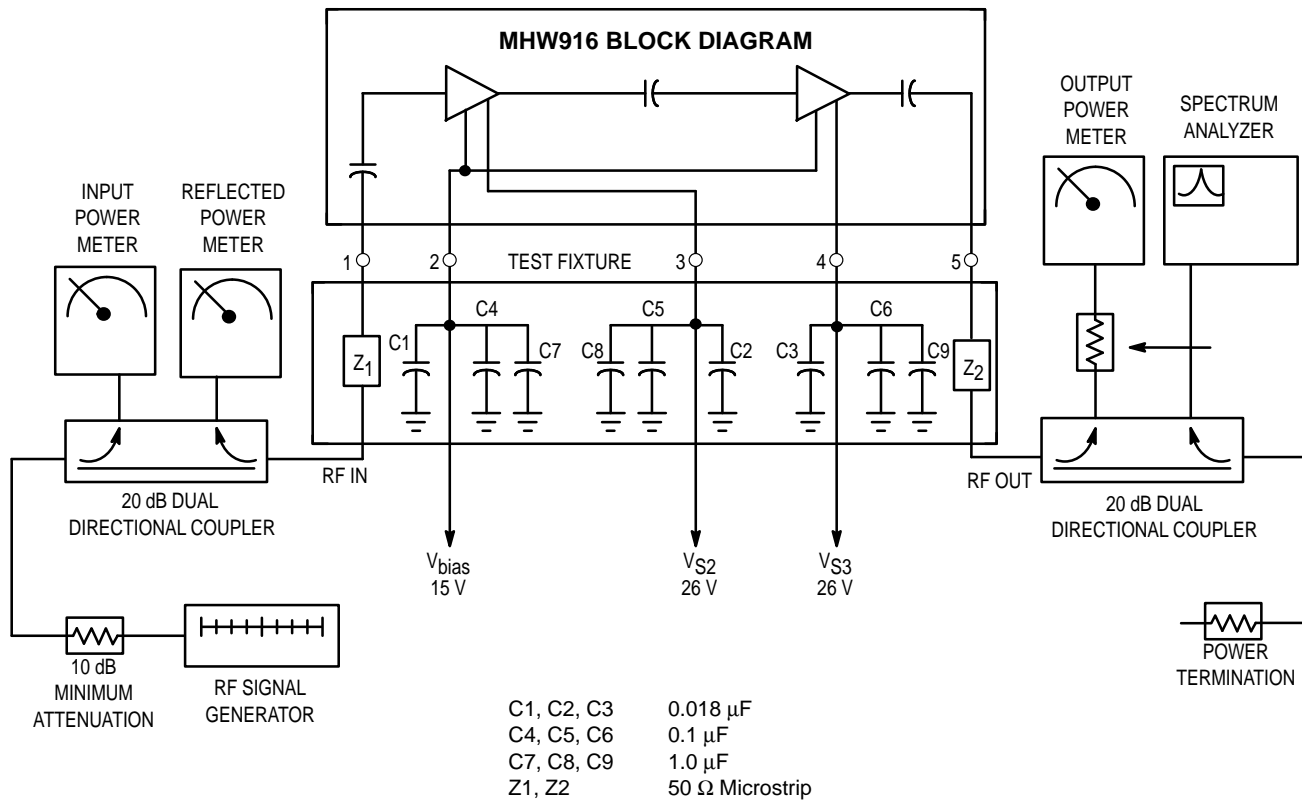

Figure 1. MHW916 Test Circuit Diagram

TYPICAL CHARACTERISTICS

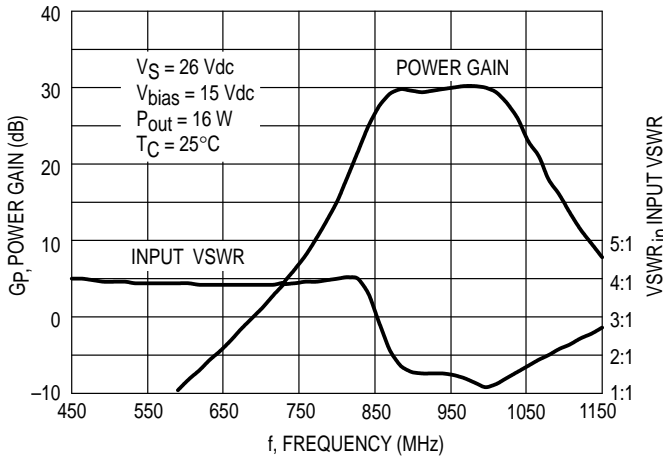

Figure 2. Power Gain and Input VSWR versus Frequency

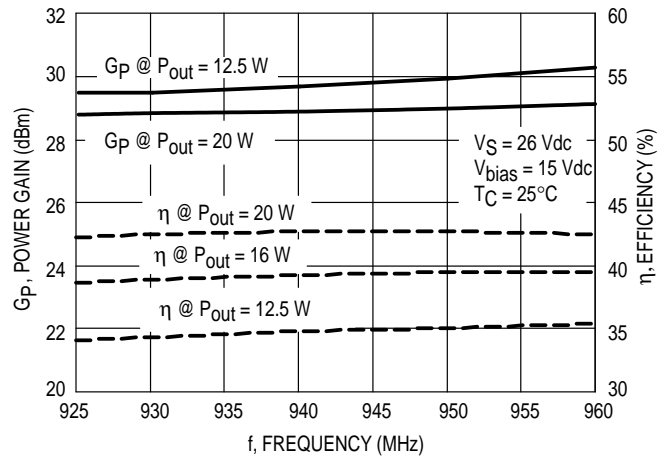

Figure 3. Power Gain and Efficiency versus Frequency

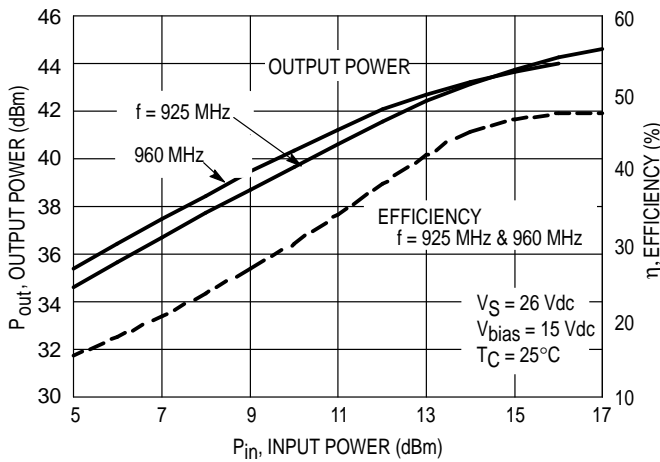

Figure 4. Output Power and Efficiency versus Input Power

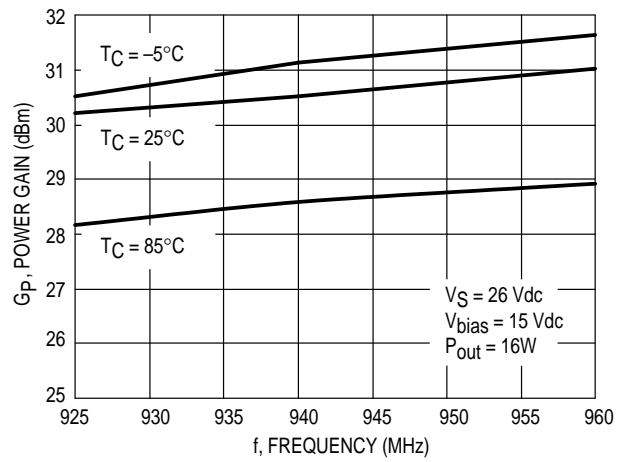

Figure 5. Power Gain versus Frequency

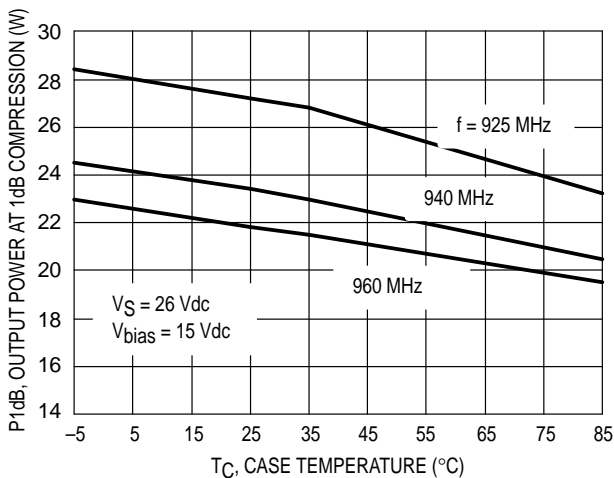

Figure 6. Output Power at 1 dB Compression versus Temperature

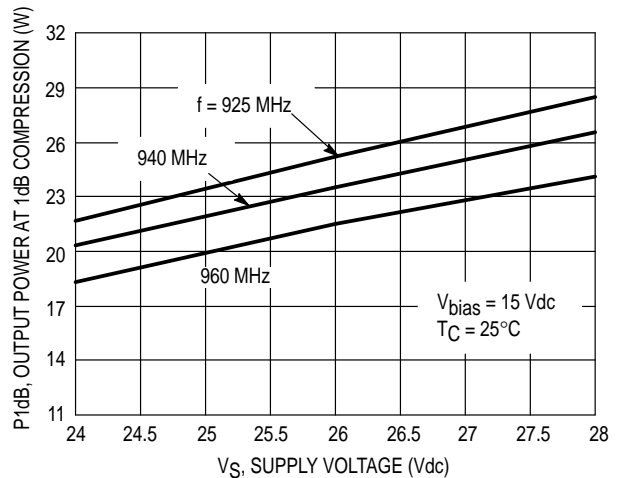
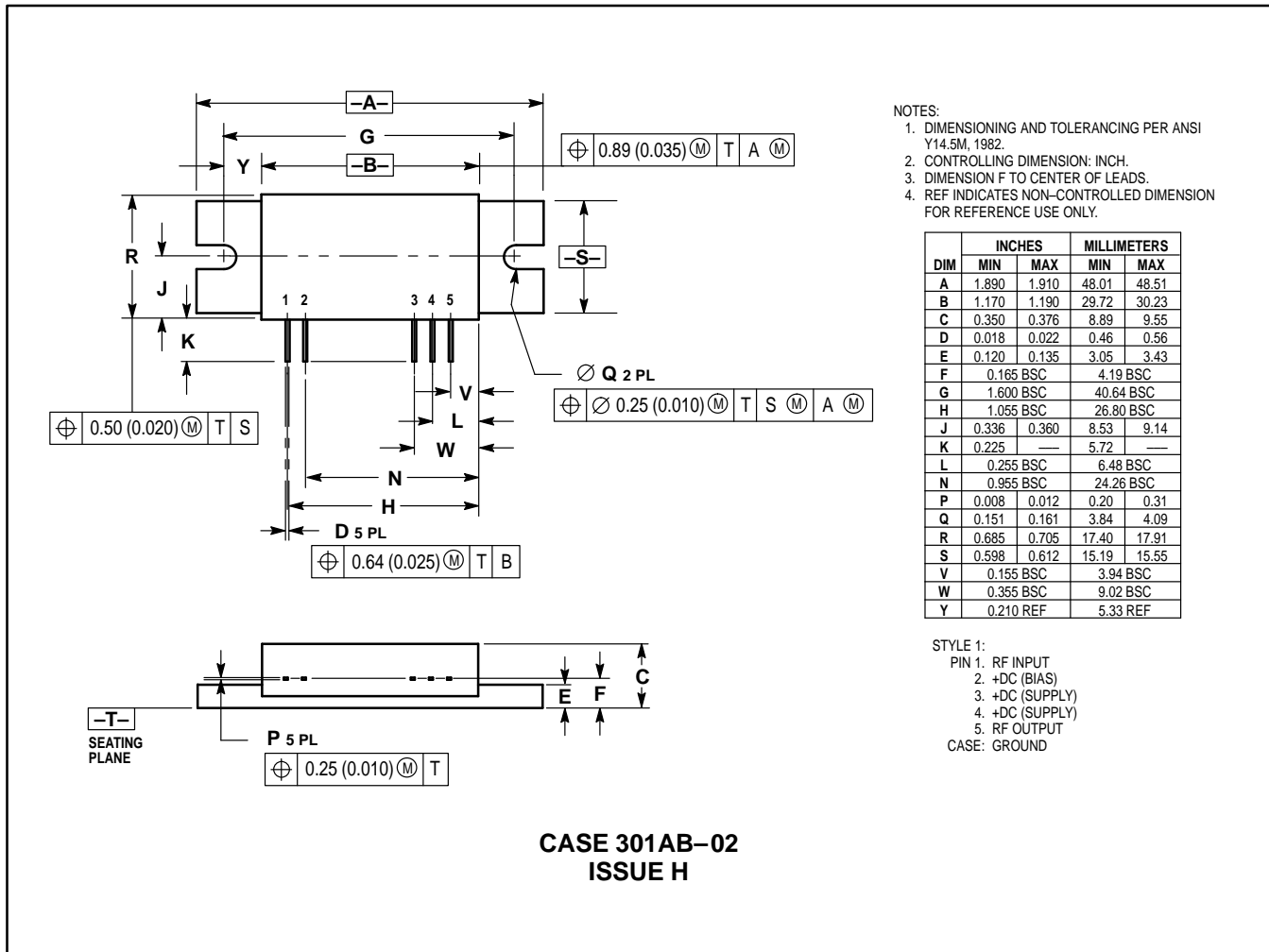

Figure 7. Output Power at 1dB Compression versus Supply Voltage

PACKAGE DIMENSIONS



Motorola reserves the right to make changes without further notice to any products herein. Motorola makes no warranty, representation or guarantee regarding the suitability of its products for any particular purpose, nor does Motorola assume any liability arising out of the application or use of any product or circuit, and specifically disclaims any and all liability, including without limitation consequential or incidental damages. "Typical" parameters which may be provided in Motorola data sheets and/or specifications can and do vary in different applications and actual performance may vary over time. All operating parameters, including "Typicals" must be validated for each customer application by customer's technical experts. Motorola does not convey any license under its patent rights nor the rights of others. Motorola products are not designed, intended, or authorized for use as components in systems intended for surgical implant into the body, or other applications intended to support or sustain life, or for any other application in which the failure of the Motorola product could create a situation where personal injury or death may occur. Should Buyer purchase or use Motorola products for any such unintended or unauthorized application, Buyer shall indemnify and hold Motorola and its officers, employees, subsidiaries, affiliates, and distributors harmless against all claims, costs, damages, and expenses, and reasonable attorney fees arising out of, directly or indirectly, any claim of personal injury or death associated with such unintended or unauthorized use, even if such claim alleges that Motorola was negligent regarding the design or manufacture of the part. Motorola and are registered trademarks of Motorola, Inc. Motorola, Inc. is an Equal Opportunity/Affirmative Action Employer.

Mfax is a trademark of Motorola, Inc.

How to reach us:

USA/EUROPE/Locations Not Listed: Motorola Literature Distribution;
 P.O. Box 5405, Denver, Colorado 80217. 1-303-675-2140 or 1-800-441-2447

JAPAN: Nippon Motorola Ltd.: SPD, Strategic Planning Office, 141,
 4-32-1 Nishi-Gotanda, Shagawa-ku, Tokyo, Japan. 03-5487-8488

Customer Focus Center: 1-800-521-6274

Mfax™: RMFAX0@email.sps.mot.com – TOUCHTONE 1-602-244-6609
 Motorola Fax Back System – US & Canada ONLY 1-800-774-1848
 – http://sps.motorola.com/mfax/

ASIA/PACIFIC: Motorola Semiconductors H.K. Ltd.; 8B Tai Ping Industrial Park,
 51 Ting Kok Road, Tai Po, N.T., Hong Kong. 852-26629298

HOME PAGE: http://motorola.com/sps/

