



75Ω/100Ω/120Ω Switchable Termination Networks

General Description

The MAX3406/MAX3407/MAX3408 are general-purpose line-terminating networks designed to change the termination value of a line, depending on the state of a digital control line, allowing the connection to a coaxial cable or a twisted pair wire. These devices are switchable between 75Ω, 100Ω, and 120Ω. The MAX3406 can switch from 75Ω to 100Ω, the MAX3407 can switch from 75Ω to 120Ω, and the MAX3408 can switch from 100Ω to 120Ω termination. Termination resistance values are guaranteed to ±2.5% through -40°C to +85°C and for signal levels of ±3.6V.

The MAX3406/MAX3407/MAX3408 consume only 50μA supply current and are fully specified for operation from a +4.5V to +5.5V power supply. These devices are available in a tiny 5-pin SOT23 package. All specifications are guaranteed over the extended temperature range of -40°C to +85°C.

Applications

Telecom E1/T1/J1 Coax/Twisted Pair Termination
Data Routers
Telecom Racks
Video Security
Industrial Networks
Ethernet Networks

Pin Configuration

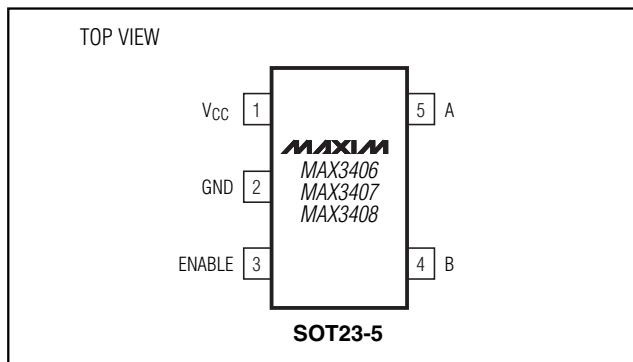

Features

- ◆ Available in 5-Pin SOT Package
- ◆ ±2.5% Resistance Accuracy Over Extended Temperature Range
- ◆ -3.6V to +3.6V Input Voltage Range
- ◆ 50μA Supply Current (max)
- ◆ Bipolar Input Range Off a Single Supply
- ◆ Switchable Termination
 - 75Ω or 100Ω (MAX3406)
 - 75Ω or 120Ω (MAX3407)
 - 100Ω or 120Ω (MAX3408)

Ordering Information

PART	TEMP. RANGE	PIN-PACKAGE	TOP MARK
MAX3406EUK	-40°C to +85°C	5 SOT23-5	ADSV
MAX3407EUK	-40°C to +85°C	5 SOT23-5	ADSW
MAX3408EUK	-40°C to +85°C	5 SOT23-5	ADSX

Selector Guide

PART	TERMINATION	
	ENABLE = 1	ENABLE = 0
MAX3406EUK	75Ω	100Ω
MAX3407EUK	75Ω	120Ω
MAX3408EUK	100Ω	120Ω

MAX3406/MAX3407/MAX3408

75Ω/100Ω/120Ω Switchable Termination Networks

ABSOLUTE MAXIMUM RATINGS

(All voltages referenced to GND unless otherwise noted.)

V _{CC}	-0.3V to +6V	Operating Temperature Range	-40°C to +85°C
ENABLE	-0.3V to (V _{CC} + 0.3V)	Maximum Junction Temperature	+150°C
A, B (applied individually)	-4V to +4V	Storage Temperature Range	-65°C to +150°C
Differential Voltage Across A-B	-4V to +4V	Lead Temperature (soldering, 10s)	+300°C
Continuous Power Dissipation (T _A = +70°C)			
5-Pin SOT23 (derate 7.1mW/°C above +70°C).....	571mW		

Stresses beyond those listed under "Absolute Maximum Ratings" may cause permanent damage to the device. These are stress ratings only, and functional operation of the device at these or any other conditions beyond those indicated in the operational sections of the specifications is not implied. Exposure to absolute maximum rating conditions for extended periods may affect device reliability.

ELECTRICAL CHARACTERISTICS

(V_{CC} = +4.5V to +5.5V, T_A = T_{MIN} to T_{MAX}, unless otherwise noted. Typical values are at V_{CC} = +5V, T_A = +25°C.) (Note 1)

PARAMETER	SYMBOL	CONDITIONS	MIN	TYP	MAX	UNITS		
DC CHARACTERISTICS								
Supply Range	V _{CC}		4.5		5.5	V		
Supply Current	I _{CC}	V _{CC} = +5.5V, ENABLE = 0 or V _{CC}		30	50	μA		
TERMINATOR NETWORK								
On-Resistance	R _{ON}	-3.6V < V _{AB} < +3.6V, ENABLE = 0	MAX3406	97.5	100	102.5	Ω	
			MAX3407/ MAX3408	117	120	123		
		-3.6V < V _{AB} < +3.6V, ENABLE = 0, frequency up to 36MHz	MAX3406		100			
			MAX3407/ MAX3408		120			
		-3.6V < V _{AB} < +3.6V, ENABLE = 1	MAX3406/ MAX3407	73.1	75	76.9		
			MAX3408	97.5	100	102.5		
-3.6V < V _{AB} < +3.6V, ENABLE = 1, frequency up to 36MHz	MAX3406/ MAX3407		75					
	MAX3408		100					
Turn-On Time	t _{ON}			50		μs		
Turn-Off Time	t _{OFF}			50		μs		
Input Low Voltage	V _{IL}				0.8	V		
Input High Voltage	V _{IH}		2.0			V		
Input Current	I _{IL} , I _{IH}	ENABLE = 0 or V _{CC}	-1		1	μA		
Input Hysteresis	V _{HYST}			200		mV		

Note 1: All parameters tested at +25°C. Limits through temperature are guaranteed by design.

75Ω/100Ω/120Ω Switchable Termination Networks

Typical Operating Characteristics

($V_{CC} = +5V$, $T_A = +25^\circ C$, unless otherwise noted.)

MAX3406/MAX3407/MAX3408

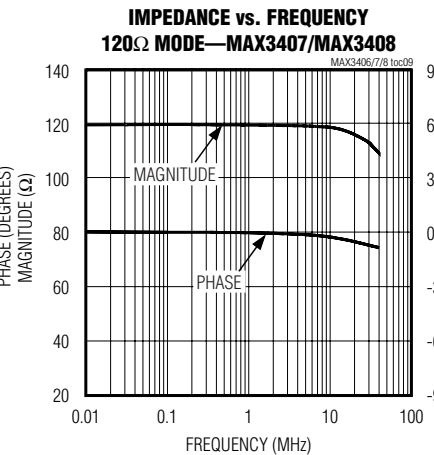
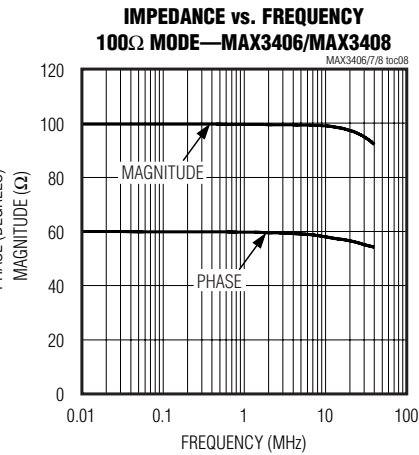
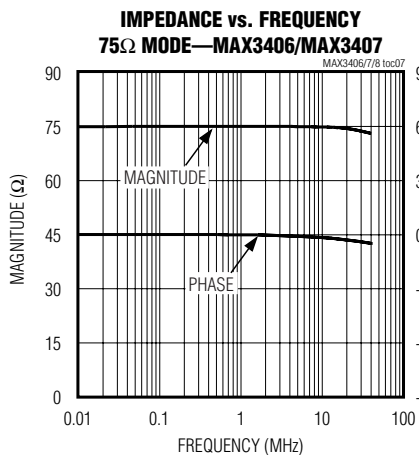
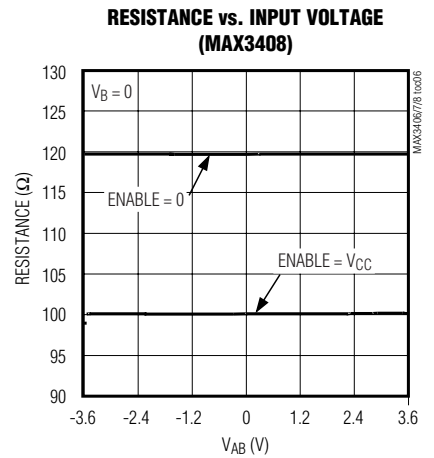
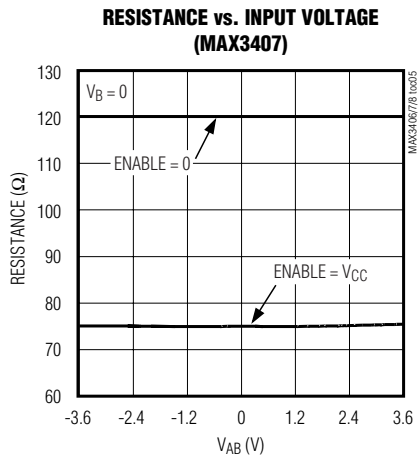
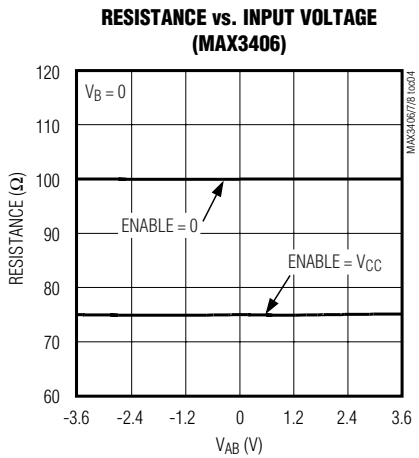
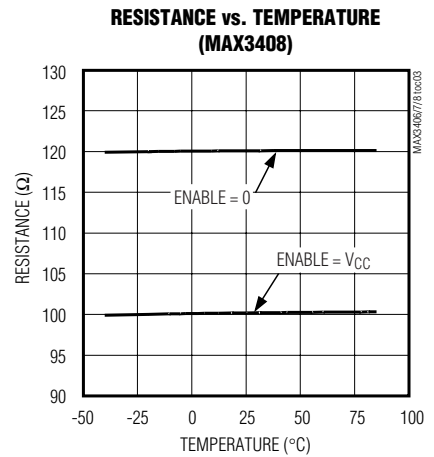
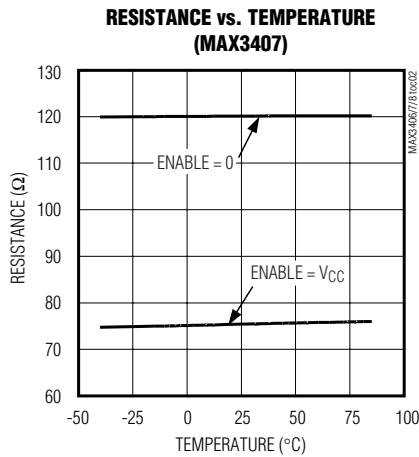
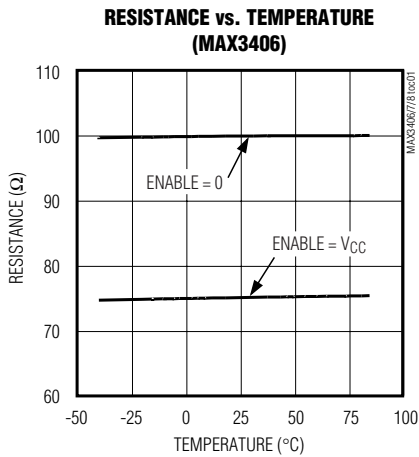

75Ω/100Ω/120Ω Switchable Termination Networks

Typical Operating Characteristics (continued)

(V_{CC} = +5V, T_A = +25°C, unless otherwise noted.)

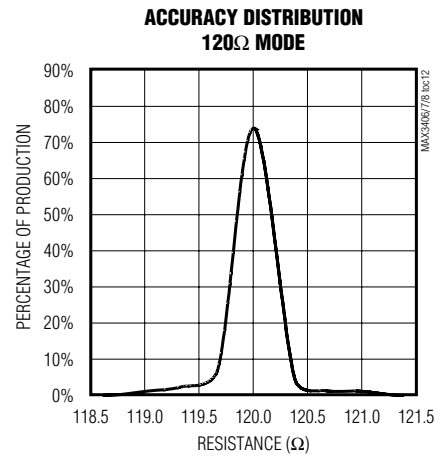
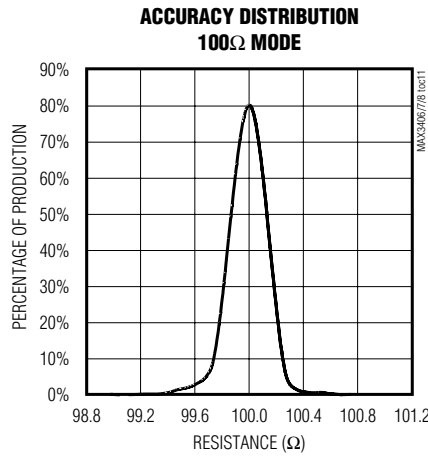
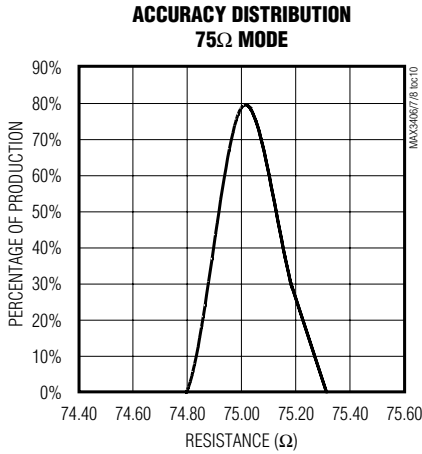

Pin Description

PIN	NAME	FUNCTION
1	V _{CC}	Supply Voltage +4.5V to +5.5V. Bypass to GND with a 0.1μF capacitor.
2	GND	Ground
3	ENABLE	Digital Control Input. Drive ENABLE high to turn on the internal switch, pull ENABLE low to disable the internal switch.
4	B	Cable Terminator Terminal B
5	A	Cable Terminator Terminal A

Detailed Description

The MAX3406/MAX3407/MAX3408 are line-terminating networks. They provide 75Ω, 100Ω, and 120Ω termination to be compatible with twisted pair or coaxial cable. The MAX3406/MAX3407/MAX3408 consume only 50μA supply current and operate from a +4.5V to +5.5V power supply. They are available in a space-saving 5-pin SOT23 package. All specifications are guaranteed over the extended temperature range of -40°C to +85°C.

The ENABLE pin allows switching from one termination value to another: 75Ω to 100Ω for the MAX3406, 75Ω to 120Ω for the MAX3407, and 100Ω to 120Ω for the MAX3408 (Figure 1 and Table 1).

Applications Information

In order for the MAX3406/MAX3407/MAX3408 to terminate transmission lines correctly, they should look like a precision resistance. These devices look this way under all operating conditions as can be seen from the *Typical Operating Characteristics*. The very small variations in resistance with temperature, input voltage, and frequency should not be of any concern in most applications, though the users should be aware of them. The next three sections describe these variations and explain what end application effect they could have.

The function of a termination is to minimize line reflections by terminating a transmission line in its characteristic impedance. The reflection coefficient for a line of Z₀ characteristic impedance terminated with a given Z_L is:

$$\text{Voltage Reflection Coefficient} = (Z_L - Z_0)/(Z_L + Z_0)$$

75Ω/100Ω/120Ω Switchable Termination Networks

MAX3406/MAX3407/MAX3408

Table 1. Termination Mode Selection

PART	R_{AB} (Ω) ENABLE = 1	R_{AB} (Ω) ENABLE = 0
MAX3406EUK	75	100
MAX3407EUK	75	120
MAX3408EUK	100	120

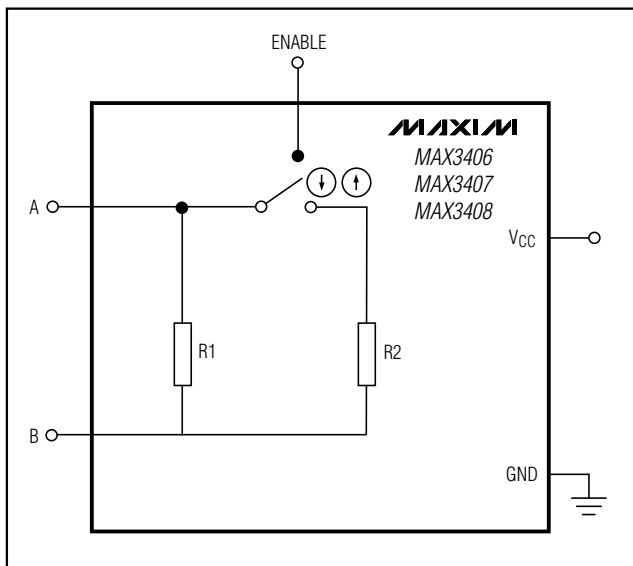

Figure 1. Simplified Block Diagram

This is the voltage that would be reflected from any line termination. As Z_L becomes equal to Z_0 , this quantity becomes zero. Often this is expressed in dB and is called return loss. Reflection coefficient values less than 0.1 corresponding to a return loss of -20dB are generally seen as adequate. The MAX3406/MAX3407/MAX3408 will typically provide reflection coefficients below 0.01 or -40dB return loss.

In most cases, Z_0 and Z_L are considered real resistive quantities and the result is a dimensionless scalar quantity, but the equation is valid in the complex case as well.

Resistance vs. Temperature

The MAX3406/MAX3407/MAX3408 resistance is constant over temperature. The typical temperature coefficient of resistance is 150ppm/°C. Over a -40°C to +85°C range centered at +25°C, this would be a ±1% change in resistance. The initial accuracy at room temperature is ±1.5%. This provides improved perfor-

mance over discrete 5% resistors with a 100ppm temp-co, which are typically used for termination, ±5.6% worst case. The reflections from such a mistermination are minimal and correspond to a worst-case reflection coefficient for the MAX3406/MAX3407/MAX3408 of ±0.015 or a -36dB return loss.

Resistance vs. Input Voltage Range

The MAX3406/MAX3407/MAX3408 accept input voltages (V_{AB}) from -3.6V to +3.6V. There is virtually no resistance variation over this range (0.02% typically). The initial accuracy specifications in the data sheet already account for resistance variations of the signal voltage range.

Impedance vs. Frequency

As seen in the *Typical Operating Characteristics*, there is a slight impedance variation in the MAX3406/MAX3407/MAX3408 with frequency. The reactive components are parasitic inductance and capacitance associated with packaging, lead frame, and bond wires. These impedance components are very small up to frequencies above 20MHz. These parasitics are also similar to those that would be present with a discrete resistor terminator, and they can generally be ignored. These effects should be evaluated for applications with significant frequency content above 20MHz. This applies to sine wave sources above 20MHz and square and video sources above 8MHz. For all intended applications, E1/T1, Standard Video, etc. they can be ignored.

Decoupling VCC

The VCC pin for the MAX3406/MAX3407/MAX3408 must be decoupled with a 0.1µF ceramic capacitor to GND placed as close to the device as possible. This is required for proper operation of the part.

Chip Information

TRANSISTOR COUNT: 102

PROCESS: BiCMOS

75Ω/100Ω/120Ω Switchable Termination Networks

Package Information

SOT5LEPS

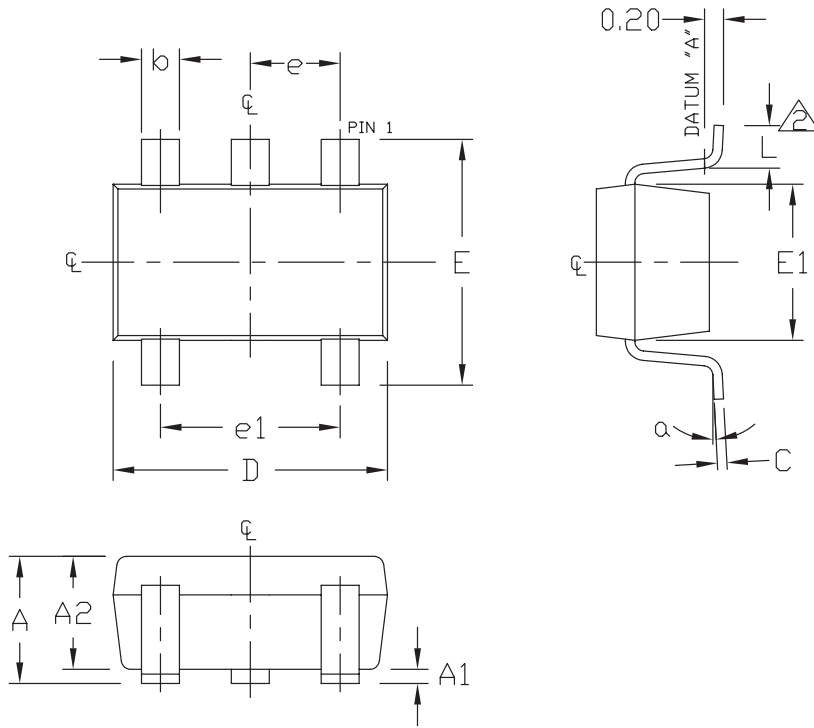

SYMBOL	MIN	MAX
A	0.90	1.45
A1	0.00	0.15
A2	0.90	1.30
b	0.35	0.50
C	0.08	0.20
D	2.80	3.00
E	2.60	3.00
E1	1.50	1.75
L	0.35	0.55
e	0.95 REF	
e1	1.90 REF	
α	0°	10°

NOTES:

1. ALL DIMENSIONS ARE IN MILLIMETERS.
2. FOOT LENGTH MEASURED AT INTERCEPT POINT BETWEEN DATUM A & LEAD SURFACE.
3. PACKAGE OUTLINE EXCLUSIVE OF MOLD FLASH & METAL BURR.
4. PACKAGE OUTLINE INCLUSIVE OF SOLDER PLATING.
5. MEETS JEDEC MO178.

MAXIM			
<small>PROPRIETARY INFORMATION</small>			
<small>TITLE:</small>			
PACKAGE OUTLINE, SOT-23, 5L			
<small>APPROVAL</small>	<small>DOCUMENT CONTROL NO.</small>	<small>REV</small>	<small>1/1</small>
	21-0057	C	

Maxim cannot assume responsibility for use of any circuitry other than circuitry entirely embodied in a Maxim product. No circuit patent licenses are implied. Maxim reserves the right to change the circuitry and specifications without notice at any time.

6 Maxim Integrated Products, 120 San Gabriel Drive, Sunnyvale, CA 94086 408-737-7600