

74ALVC16374

Low Voltage 16-Bit D-Type Flip-Flop with 3.6V Tolerant Inputs and Outputs

General Description

The ALVC16374 contains sixteen non-inverting D-type flip-flops with 3-STATE outputs and is intended for bus oriented applications. The device is byte controlled. A buffered clock (CP) and output enable (\overline{OE}) are common to each byte and can be shorted together for full 16-bit operation.

The 74ALVC16374 is designed for low voltage (1.65V to 3.6V) V_{CC} applications with I/O compatibility up to 3.6V.

The 74ALVC16374 is fabricated with an advanced CMOS technology to achieve high speed operation while maintaining low CMOS power dissipation.

Features

- 1.65V - 3.6V V_{CC} supply operation
- 3.6V tolerant inputs and outputs
- t_{PD}
 - 3.5 ns max for 3.0V to 3.6V V_{CC}
 - 4.4 ns max for 2.3V to 2.7V V_{CC}
 - 7.8 ns max for 1.65V to 1.95V V_{CC}
- Power-off high impedance inputs and outputs
- Supports live insertion and withdrawal (Note 1)
- Uses patented noise/EMI reduction circuitry
- Latchup conforms to JEDEC JED78
- ESD performance:
 - Human body model > 2000V
 - Machine model > 200V
- Also packaged in plastic Fine-Pitch Ball Grid Array (FBGA)

Note 1: To ensure the high-impedance state during power up or power down, \overline{OE} should be tied to V_{CC} through a pull-up resistor; the minimum value of the resistor is determined by the current-sourcing capability of the driver.

Ordering Code:

| Order Number | Package Number | Package Descriptions |
|----------------------------|----------------|-------------------------------------------------------------------------------------|
| 74ALVC16374GX (Note 2) | BGA54A | 54-Ball Fine-Pitch Ball Grid Array (FBGA), JEDEC MO-205, 5.5mm Wide [TAPE and REEL] |
| 74ALVC16374MTD (Note 3) | MTD48 | 48-Lead Thin Shrink Small Outline Package (TSSOP), JEDEC MO-153, 6.1mm Wide |

Note 2: BGA package available in Tape and Reel only.

Note 3: Devices also available in Tape and Reel. Specify by appending suffix letter "X" to the ordering code.

74ALVC16374 Low Voltage 16-Bit D-Type Flip-Flop with 3.6V Tolerant Inputs and Outputs

Logic Symbol

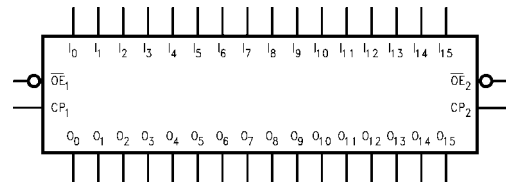

Connection Diagrams

Pin Assignment for TSSOP

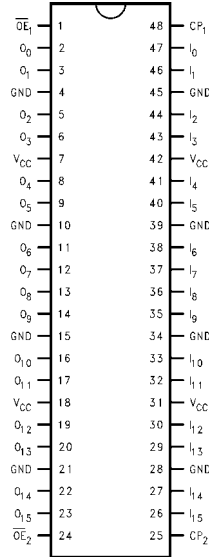

Pin Assignment for FBGA

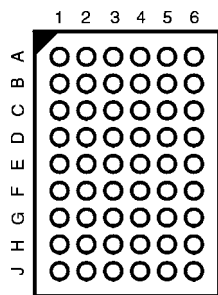

(Top Thru View)

Pin Descriptions

| Pin Names | Description |
|-------------------|----------------------------------|
| \overline{OE}_n | Output Enable Input (Active LOW) |
| CP_n | Clock Pulse Input |
| I_0-I_{15} | Inputs |
| O_0-O_{15} | Outputs |
| NC | No Connect |

FBGA Pin Assignments

| | 1 | 2 | 3 | 4 | 5 | 6 |
|----------|----------|----------|-------------------|----------|----------|----------|
| A | O_0 | NC | \overline{OE}_1 | CP_1 | NC | I_0 |
| B | O_2 | O_1 | NC | NC | I_1 | I_2 |
| C | O_4 | O_3 | V_{CC} | V_{CC} | I_3 | I_4 |
| D | O_6 | O_5 | GND | GND | I_5 | I_6 |
| E | O_8 | O_7 | GND | GND | I_7 | I_8 |
| F | O_{10} | O_9 | GND | GND | I_9 | I_{10} |
| G | O_{12} | O_{11} | V_{CC} | V_{CC} | I_{11} | I_{12} |
| H | O_{14} | O_{13} | NC | NC | I_{13} | I_{14} |
| J | O_{15} | NC | \overline{OE}_2 | CP_2 | NC | I_{15} |

Truth Tables

| Inputs | | | Outputs |
|--------|-------------------|-----------|-----------|
| CP_1 | \overline{OE}_1 | I_0-I_7 | O_0-O_7 |
| ↗ | L | H | H |
| ↗ | L | L | L |
| L | L | X | O_0 |
| X | H | X | Z |

| Inputs | | | Outputs |
|--------|-------------------|--------------|--------------|
| CP_2 | \overline{OE}_2 | I_8-I_{15} | O_8-O_{15} |
| ↗ | L | H | H |
| ↗ | L | L | L |
| L | L | X | O_0 |
| X | H | X | Z |

H = HIGH Voltage Level
 L = LOW Voltage Level
 X = Immaterial (HIGH or LOW, inputs may not float)
 Z = High Impedance
 O_0 = Previous O_0 before HIGH-to-LOW of CP

Functional Description

The 74ALVC16374 consists of sixteen edge-triggered flip-flops with individual D-type inputs and 3-STATE true outputs. The device is byte controlled with each byte functioning identically, but independent of the other. The control pins can be shorted together to obtain full 16-bit operation. Each clock has a buffered clock and buffered Output Enable common to all flip-flops within that byte. The description which follows applies to each byte. Each

flip-flop will store the state of their individual I inputs that meet the setup and hold time requirements on the LOW-to-HIGH Clock (CP_n) transition. With the Output Enable (\overline{OE}_n) LOW, the contents of the flip-flops are available at the outputs. When \overline{OE}_n is HIGH, the outputs go to the high impedance state. Operations of the \overline{OE}_n input does not affect the state of the flip-flops.

Logic Diagram

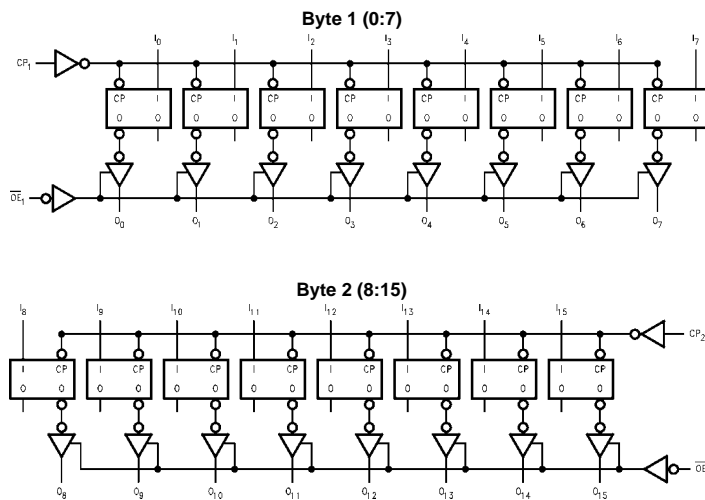

Please note that this diagram is provided only for the understanding of logic operations and should not be used to estimate propagation delays.

Absolute Maximum Ratings (Note 4)

| | |
|--------------------------------------------------------------|--------------------------|
| Supply Voltage (V_{CC}) | -0.5V to +4.6V |
| DC Input Voltage (V_I) | -0.5V to 4.6V |
| Output Voltage (V_O) (Note 5) | -0.5V to $V_{CC} + 0.5V$ |
| DC Input Diode Current (I_{IK}) | |
| $V_I < 0V$ | -50 mA |
| DC Output Diode Current (I_{OK}) | |
| $V_O < 0V$ | -50 mA |
| DC Output Source/Sink Current (I_{OH}/I_{OL}) | ± 50 mA |
| DC V_{CC} or GND Current per Supply Pin (I_{CC} or GND) | ± 100 mA |
| Storage Temperature Range (T_{STG}) | -65°C to +150°C |

Recommended Operating Conditions (Note 6)

| | |
|-------------------------------------------------|----------------|
| Power Supply | |
| Operating | 1.65V to 3.6V |
| Input Voltage (V_I) | 0V to V_{CC} |
| Output Voltage (V_O) | 0V to V_{CC} |
| Free Air Operating Temperature (T_A) | -40°C to +85°C |
| Minimum Input Edge Rate ($\Delta t/\Delta V$) | |
| $V_{IN} = 0.8V$ to 2.0V, $V_{CC} = 3.0V$ | 10 ns/V |

Note 4: The Absolute Maximum Ratings are those values beyond which the safety of the device cannot be guaranteed. The device should not be operated at these limits. The parametric values defined in the Electrical Characteristics tables are not guaranteed at the Absolute Maximum Ratings. The "Recommended Operating Conditions" table will define the conditions for actual device operation.

Note 5: I_O Absolute Maximum Rating must be observed.

Note 6: Floating or unused inputs must be held HIGH or LOW.

DC Electrical Characteristics

| Symbol | Parameter | Conditions | V_{CC} (V) | Min | Max | Units |
|-----------------|--------------------------------|-----------------------------------------------------------------------------------------------------------------------------------------|---------------------------------------|-------------------------------------------------|------------------------------------------|---------|
| V_{IH} | HIGH Level Input Voltage | | 1.65 - 1.95 2.3 - 2.7 2.7 - 3.6 | $0.65 \times V_{CC}$ 1.7 2.0 | | V |
| V_{IL} | LOW Level Input Voltage | | 1.65 - 1.95 2.3 - 2.7 2.7 - 3.6 | | $0.35 \times V_{CC}$ 0.7 0.8 | V |
| V_{OH} | HIGH Level Output Voltage | $I_{OH} = -100 \mu A$ $I_{OH} = -4 \text{ mA}$ $I_{OH} = -6 \text{ mA}$ $I_{OH} = -12 \text{ mA}$ $I_{OH} = -24 \text{ mA}$ | 1.65 - 3.6 | $V_{CC} - 0.2$ 1.2 2 1.7 2.2 2.4 | | V |
| V_{OL} | LOW Level Output Voltage | $I_{OL} = 100 \mu A$ $I_{OL} = 4 \text{ mA}$ $I_{OL} = 6 \text{ mA}$ $I_{OL} = 12 \text{ mA}$ $I_{OL} = 24 \text{ mA}$ | 1.65 - 3.6 | | 0.2 0.45 0.4 0.7 0.4 0.55 | V |
| I_I | Input Leakage Current | $0 \leq V_I \leq 3.6V$ | 3.6 | | ± 5.0 | μA |
| I_{OZ} | 3-STATE Output Leakage | $0 \leq V_O \leq 3.6V$ | 3.6 | | ± 10 | μA |
| I_{CC} | Quiescent Supply Current | $V_I = V_{CC}$ or GND, $I_O = 0$ | 3.6 | | 40 | μA |
| ΔI_{CC} | Increase in I_{CC} per Input | $V_{IH} = V_{CC} - 0.6V$ | 3 - 3.6 | | 750 | μA |

| AC Electrical Characteristics | | | | | | | | | | |
|-------------------------------|---------------------------------|------------------------------------------------------------------|-----------------------------------------|-----------------|-------|--------------------------|-----|---------------------------|-----|-------|
| Symbol | Parameter | $T_A = -40^\circ\text{C to } +85^\circ\text{C}, R_L = 500\Omega$ | | | | | | | | Units |
| | | $C_L = 50\text{ pF}$ | | | | $C_L = 30\text{ pF}$ | | | | |
| | | $V_{CC} = 3.3V \pm 0.3V$ | | $V_{CC} = 2.7V$ | | $V_{CC} = 2.5V \pm 0.2V$ | | $V_{CC} = 1.8V \pm 0.15V$ | | |
| | | Min | Max | Min | Max | Min | Max | Min | Max | |
| f_{MAX} | Maximum Clock Frequency | 250 | | 200 | | 200 | | 100 | | ns |
| t_{PHL}, t_{PLH} | Propagation Delay Bus to Bus | 1.3 | 3.5 | 1.5 | 4.4 | 1.0 | 3.9 | 1.5 | 7.8 | ns |
| t_{PZL}, t_{PZH} | Output Enable Time | 1.3 | 4.0 | 1.5 | 5.1 | 1.0 | 4.6 | 1.5 | 9.2 | ns |
| t_{PLZ}, t_{PHZ} | Output Disable Time | 1.3 | 4.0 | 1.5 | 4.3 | 1.0 | 3.8 | 1.5 | 6.8 | ns |
| t_W | Pulse Width | 1.5 | | 1.5 | | 1.5 | | 4.0 | | ns |
| t_S | Setup Time | 1.5 | | 1.5 | | 1.5 | | 2.5 | | ns |
| t_H | Hold Time | 1.0 | | 1.0 | | 1.0 | | 1.0 | | ns |
| Capacitance | | | | | | | | | | |
| Symbol | Parameter | Conditions | $T_A = +25^\circ\text{C}$ | | Units | | | | | |
| | | | V_{CC} | Typical | | | | | | |
| C_{IN} | Input Capacitance | $V_I = 0V \text{ or } V_{CC}$ | 3.3 | 6 | pF | | | | | |
| C_{OUT} | Output Capacitance | $V_I = 0V \text{ or } V_{CC}$ | 3.3 | 7 | pF | | | | | |
| C_{PD} | Power Dissipation Capacitance | Outputs Enabled | $f = 10\text{ MHz}, C_L = 50\text{ pF}$ | 3.3 | 20 | pF | | | | |
| | | | | 2.5 | 20 | | | | | |

AC Loading and Waveforms

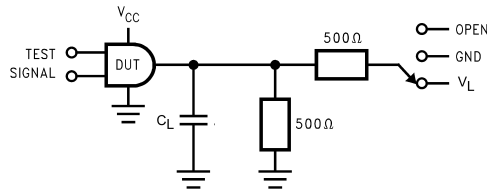

FIGURE 1. AC Test Circuit

TABLE 1.

| TEST | SWITCH |
|-----------------------|--------|
| t_{PLH} , t_{PHL} | Open |
| t_{PZL} , t_{PLZ} | V_L |
| t_{PZH} , t_{PHZ} | GND |

TABLE 2.

| Symbol | V_{CC} | | | |
|----------|-----------------|-----------------|------------------|------------------|
| | $3.3V \pm 0.3V$ | 2.7V | $2.5V \pm 0.2V$ | $1.8V \pm 0.15V$ |
| V_{mi} | 1.5V | 1.5V | $V_{CC}/2$ | $V_{CC}/2$ |
| V_{mo} | 1.5V | 1.5V | $V_{CC}/2$ | $V_{CC}/2$ |
| V_X | $V_{OL} + 0.3V$ | $V_{OL} + 0.3V$ | $V_{OL} + 0.15V$ | $V_{OL} + 0.15V$ |
| V_Y | $V_{OL} - 0.3V$ | $V_{OL} - 0.3V$ | $V_{OL} - 0.15V$ | $V_{OL} - 0.15V$ |
| V_L | $V/6$ | 6V | $V_{CC} * 2$ | $V_{CC} * 2$ |

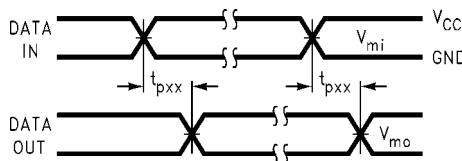

FIGURE 2. Waveform for Inverting and Non-Inverting Functions

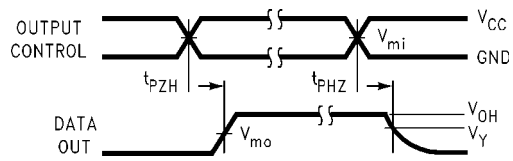

FIGURE 3. 3-STATE Output High Enable and Disable Times for Low Voltage Logic

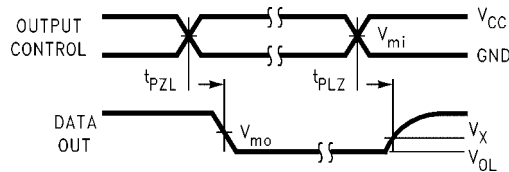

FIGURE 4. 3-STATE Output Low Enable and Disable Times for Low Voltage Logic

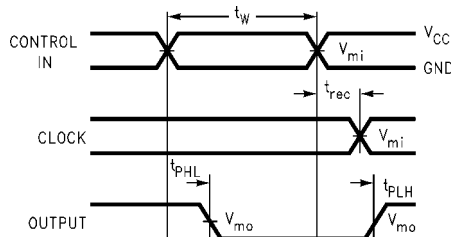

FIGURE 5. Propagation Delay, Pulse Width and t_{rec} Waveforms

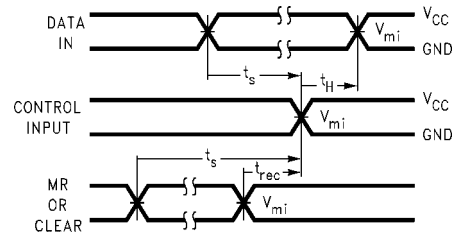
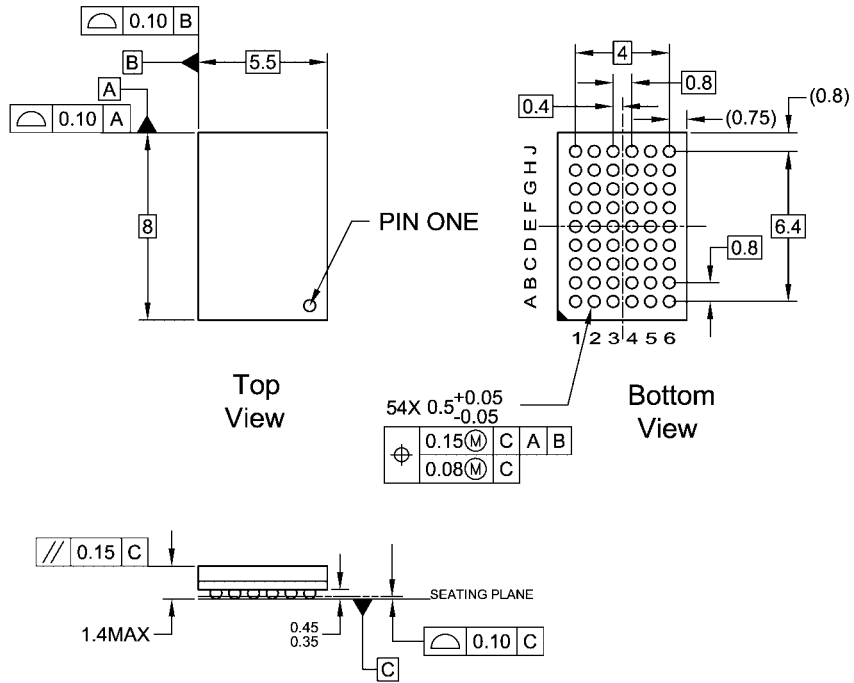

FIGURE 6. Setup Time, Hold Time and Recovery Time for Low Voltage Logic

Physical Dimensions inches (millimeters) unless otherwise noted



- NOTES:
- A. THIS PACKAGE CONFORMS TO JEDEC M0-205
 - B. ALL DIMENSIONS IN MILLIMETERS
 - C. LAND PATTERN RECOMMENDATION: NSMD (Non Solder Mask Defined)
.35MM DIA PADS WITH A SOLDERMASK OPENING OF .45MM CONCENTRIC TO PADS
 - D. DRAWING CONFORMS TO ASME Y14.5M-1994

BGA54ArevD

**54-Ball Fine-Pitch Ball Grid Array (FBGA), JEDEC M0-205, 5.5mm Wide
Package Number BGA54A**

Physical Dimensions inches (millimeters) unless otherwise noted (Continued)

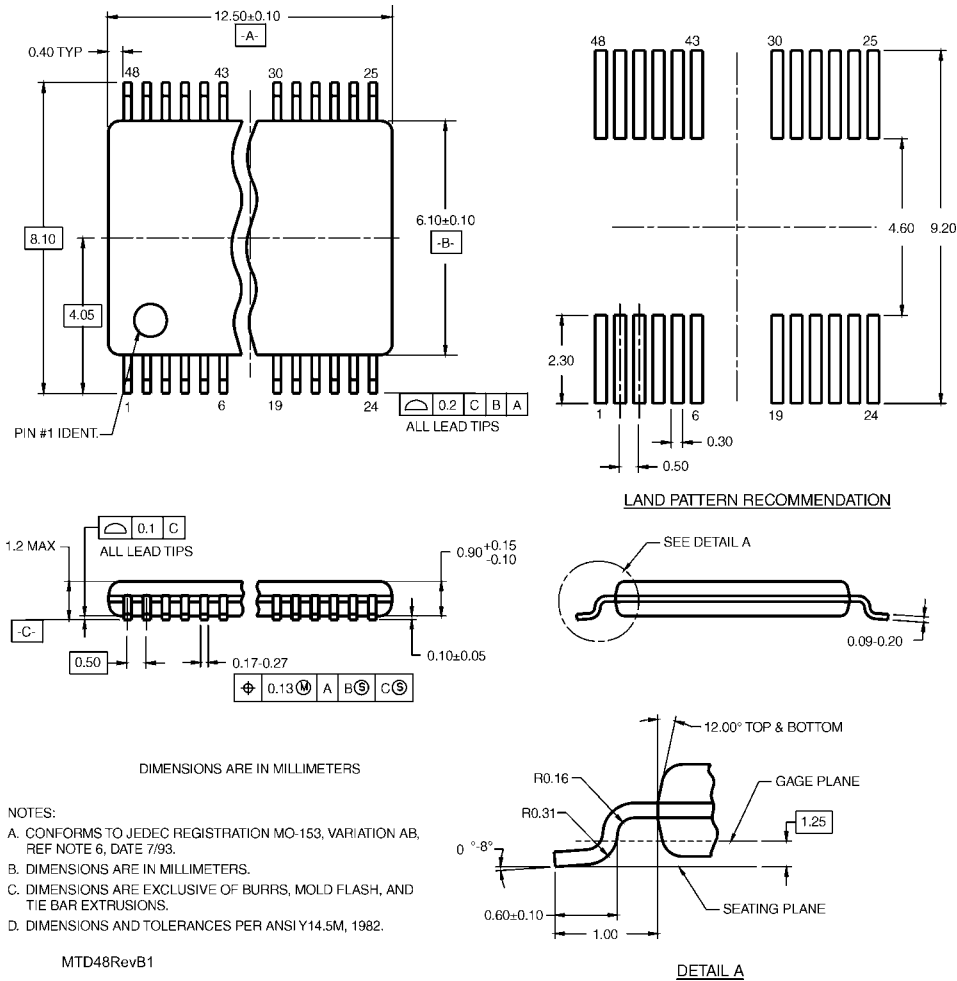

Fairchild does not assume any responsibility for use of any circuitry described, no circuit patent licenses are implied and Fairchild reserves the right at any time without notice to change said circuitry and specifications.

LIFE SUPPORT POLICY

FAIRCHILD'S PRODUCTS ARE NOT AUTHORIZED FOR USE AS CRITICAL COMPONENTS IN LIFE SUPPORT DEVICES OR SYSTEMS WITHOUT THE EXPRESS WRITTEN APPROVAL OF THE PRESIDENT OF FAIRCHILD SEMICONDUCTOR CORPORATION. As used herein:

1. Life support devices or systems are devices or systems which, (a) are intended for surgical implant into the body, or (b) support or sustain life, and (c) whose failure to perform when properly used in accordance with instructions for use provided in the labeling, can be reasonably expected to result in a significant injury to the user.
2. A critical component in any component of a life support device or system whose failure to perform can be reasonably expected to cause the failure of the life support device or system, or to affect its safety or effectiveness.

www.fairchildsemi.com